



Aluminum Electrolytic Capacitor Catalogue

Table of Contents

| Page | Production Guide |
|------|---|
| 3 | Series Index |
| 6 | Electrolytic capacitors - Application Guide Series Chart |
| 11 | Explanation of parts numbers |
| | Conductive Polymer Aluminum Electrolytic Capacitors |
| 12 | Precautions in using |
| 18 | Environmental consideration |
| | Product specification of conductive Polymer Hybrid capacitor |
| 19 | Radial Type series (HRA, HRB) |
| 23 | Surface Mount Type series (HSA, HSB, HSC, HSD, HSE) |
| | Product specification of solid electrolytic capacitor |
| 33 | Radial Type series (PRA, PRB, PRC, PRD, PRE, PRF,PRG,PRH) |
| 49 | Surface Mount Type series (PSA, PSB, PSC, PSD, PSE, PSF,PSG,PSH) |
| 68 | Conductive Polymer Aluminum Electrolytic Capacitors Package Specification |
| | Aluminum Electrolytic Capacitors |
| 70 | Precautions in using |
| 72 | Environmental consideration |
| | Product specification of electrolytic capacitor |
| 76 | Anhydrous Type series (ATA, ATB, ATC, ATD, ATE) |
| 92 | Snap-In Type series (SIA, SIC, SID, SIE, SIF,SIG) |
| 113 | Surface Mount Type series (SMA, SMB, SMC, SMD, SME, SMF, SMG, SMH, SMDL, SMN, SMJ, SMK, SML, SMM) |
| 146 | Screw Terminal Type series (STA, STB, STC, STD, STE) |
| 162 | LUG Terminal Type series (LTC, LTD) |
| 167 | Radial Type High Reliability series (RHA, RHB, RHC, RHD, RHI, RHJ, RHK, RHL, RMI) |
| 187 | Radial Type for Ballast series (RHE, RHF, RHH) |
| 196 | Radial Type Low Impedance series (RLA, RLB, RLC, RLD, RLE, RLF, RLG, RLJ, RLK,RLM) |
| 227 | Radial Type Miniature series (RMB, RMC, RME, RMG, RMH) |
| 237 | Radial Type Non-Polarized series (RNC, RND, RNE) |
| 245 | Radial Type Special series (RPB) |
| 254 | Radial Type Standard series (RSA, RSB, RSC, RSD, RSE, RSF) |
| 270 | Aluminum Electrolytic Capacitors Package Specification |
| 276 | Marking Specifications |

Aluminum Electrolytic Capacitor – Series Index

Conductive Polymer Hybrid Aluminum Electrolytic Capacitors

| Series | INX Series | Applications | Rated Voltage(V) | Capacitance Range(uF) | Temperature Range(°C) | Load Life (hrs) | AEC-Q200 compliant |
|-------------|------------|---|------------------|-----------------------|-----------------------|-----------------|--------------------|
| Radial Type | HRA | Low ESR | 16~125 | 10~560 | -55 to +105 | 5,000~10,000 | ● |
| | HRB | High temperature, Low ESR | 16~50 | 15~560 | -55 to +125 | 2,000~4,000 | ● |
| Type SMD | HSA | Low ESR | 16~125 | 10~560 | -55 to +105 | 5,000~10,000 | ● |
| | HSB | High temperature, Low ESR | 16~125 | 10~560 | -55 to +125 | 2,000~4,000 | ● |
| | HSC | High temperature, Low ESR, Anti-vibration | 16~125 | 10~560 | -55 to +105 | 10,000 | ● |
| | HSD | High temperature, Low ESR, Anti-vibration | 16~125 | 10~560 | -55 to +125 | 4,000 | ● |
| | HSE | High temperature 135°C, Low ESR | 25~63 | 10~330 | -55 to +135 | 1,000~2,000 | ● |

Conductive Polymer Solid Aluminum Capacitors

| Series | INX Series | Applications | Rated Voltage(V) | Capacitance Range(uF) | Temperature Range(°C) | Load Life (hrs) | AEC-Q200 compliant |
|-------------|------------|--|------------------|-----------------------|-----------------------|-----------------|--------------------|
| Radial Type | PRA | Standard | 2.5~25 | 6.8~2,700 | -55 to +105 | 2,000 | |
| | PRB | Ultra impedance, high ripple current | 2.5~16 | 82~2,700 | -55 to +105 | 2,000 | |
| | PRC | Long life | 2.5~50 | 10~2,200 | -55 to +105 | 5,000 | ● |
| | PRD | High voltage standard, high ripple current | 35~100 | 12~470 | -55 to +105 | 2,000 | |
| | PRE | High temperature, Low ESR | 4~50 | 10~2,500 | -55 to +125 | 1,000 | ● |
| | PRF | High temperature, Long Life | 6.3~35 | 56~1800 | -55 to +125 | 2,000 | ● |
| | PRG | Long life Low ESR | 2.5~50 | 10~2,200 | -55 to +105 | 20,000 | |
| | PRH | Ultra impedance, high ripple current | 2.5~63 | 10~2,700 | -55 to +105 | 15,000 | |
| SMD Type | PSA | Standard | 2.5~25 | 22~2,700 | -55 to +105 | 2,000 | |
| | PSB | Low impedance, high ripple current | 2.5~16 | 68~2,700 | -55 to +105 | 2,000 | |
| | PSC | Long life, Low ESR, high ripple current | 4~50 | 10~2,200 | -55 to +105 | 5,000 | ● |
| | PSD | Low ESR, high voltage, High ripple current | 35~100 | 12~220 | -55 to +105 | 2,000 | |
| | PSE | High temperature, Low ESR | 4~50 | 10~2,200 | -55 to +125 | 1,000 | ● |
| | PSF | High temperature, Long life | 6.3~35 | 56~1800 | -55 to +125 | 2,000 | ● |
| | PSG | Ultra impedance, high ripple current | 2.5-63 | 10~2,700 | -55 to +105 | 15,000 | |
| | PSH | Long life Low ESR | 2.5-50 | 10~2,200 | -55 to +105 | 20,000 | |

Aluminum Electrolytic Capacitor – Surface Mount Type

| Series | INX Series | Applications | Rated Voltage(V) | Capacitance Range(uF) | Temperature Range(°C) | Load Life (hrs) | AEC-Q200 compliant |
|---------------|------------|-----------------|------------------|-----------------------|-----------------------|-----------------|--------------------|
| Surface mount | SMA | Standard, 85°C | 4~100 | 0.1~1,500 | -55 to +85 | 2,000 | |
| | SMB | Standard, 105°C | 4~50 | 0.1~1,500 | -55 to +105 | 1,000 | |
| | SMC | Bi-Polarized | 6.3~50 | 0.1~100 | -55 to +85 | 1,000 | ● |
| | SMD | Low impedance | 6.3~100 | 1~1,500 | -55 to +105 | 2,000~3,000 | ● |
| | SME | Long life 105°C | 6.3~100 | 1~6,800 | -55 to +105 | 2,000 | ● |

Aluminum Electrolytic Capacitor – Surface Mount Type

| Series | INX Series | Applications | Rated Voltage(V) | Capacitance Range(uF) | Temperature Range(°C) | Load Life (hrs) | AEC-Q200 compliant |
|---------------|-----------------|--|------------------|-----------------------|----------------------------|-----------------|--------------------|
| Surface mount | SMF | Long life 125°C | 10~63 80~160 | 2.2~470 | -55 to +125 -40 to +125 | 2,000~3,000 | ● |
| | SMG | High voltage 400V | 160~400 | 2.2~82 | -40 to +105 | 2,000 | ● |
| | SMH | Long life,105°C | 6.3~50 | 22~1000 | -40 to +105 | 5,000 | ● |
| | SMDL | Long life,105°C | 6.3~100 | 22~1500 | -55 to +105 | 5,000 | ● |
| | SMN | Low impedance, Long life,125°C | 16~50 | 33~330 | -40 to +125 | 3,000 | ● |
| | SMJ | Low impedance, | 6.3~100 | 1~4700 | -55 to +125 | 1,000~2,000 | ● |
| | SMK | Low impedance, Anti-vibration. | 6.3~100 | 1~4700 | -55 to +125 | 1,000~2,000 | ● |
| | SML | Low impedance, Long life, 125°C | 16~50 | 33~2200 | -40 to +125 | 2,000~5,000 | ● |
| | SMM | Low impedance, Long life,125°C, Anti-vibration | 16~50 | 33~2200 | -40 to +125 | 2,000~5,000 | ● |
| | SMO | Long Life, Lower Impedance | 6.3~50 | 10~1000 | -25 to +105 | 7000~10000 | ● |
| | SMP | Downsizing and Lower Impedance | 6.3~50 | 22~2200 | -55 to +105 | 2,000 | ● |
| SMQ | Long life,135°C | 10~63 | 33~2200 | -40 to +135 | 2,000 | ● | |

Aluminum Electrolytic Capacitor – Radial Type

| Series | INX Series | Applications | Rated Voltage(V) | Capacitance Range(uF) | Temperature Range(°C) | Load Life (hrs) | AEC-Q200 compliant |
|------------------|------------|---|--------------------|-----------------------|----------------------------|-----------------|--------------------|
| Miniature | RMB | 5mm height, 105°C | 4~50 | 0.1~220 | -40 to +105 | 1,000 | |
| | RMC | 5mm height, Low impedance | 6.3~35 | 1~100 | -40 to +105 | 1,000 | |
| | RME | 7mm height, 105°C | 6.3~50 | 0.1~330 | -40 to +105 | 1,000 | |
| | RMG | 7mm height, Low impedance | 6.3~35 | 6.8~220 | -40 to +105 | 1,000 | |
| | RMH | 7mm height, Long life | 6.3~50 | 0.1~220 | -40 to +105 | 5,000 | |
| Standard | RSA | Standard, 85°C | 6.3~250 350~500 | 0.1~33,000 | -40 to +85 -25 to 85 | 2000 | |
| | RSE | Long life, 85°C | 400 450~500 | 10~150 | -40 to +85 -25 to +85 | 8,000 | |
| | RSB | Standard, 105°C | 6.3~250 350~500 | 0.1~22,000 | -40 to +105 -25 to +105 | 2,000 | |
| | RSF | High voltage, High ripple current | 400 450~500 | 10~150 | -40 to +105 -25 to +105 | 2,000 | |
| | RSC | High ripple current | 160~400 450 | 22~470 | -40 to +105 -25 to +105 | 2,000 | |
| | RSD | High ripple current, 3000hrs | 6.3~250 350~450 | 0.1~22,000 | -40 to +105 -25 to +105 | 3,000 | |
| | RSG | -55°C Low temperature resistant product | 400~450 | 10~150 | -55 to +105 | 2000 | |
| High Reliability | RHA | Long life, 5000hrs | 6.3~250 350~450 | 0.47~22,000 | -40 to +105 -25 to +105 | 3,000~5,000 | |
| | RHK | High voltage, High ripple current | 400 450~500 | 10~150 | -40 to +105 -25 to +105 | 5,000 | |
| | RHB | Long life,High ripple current, 5000hrs | 160~400 450 | 22~470 | -40 to +105 -25 to +105 | 5,000 | |
| | RHC | Long life, 10000hrs | 160~400 450 | 6.8~220 | -40 to +105 -25 to +105 | 10,000 | |
| | RMI | Miniaturized and Long life | 10~100 | 0.47~330 | -25 to +105 | 10,000 | |
| | RHI | Long life,12000hrs | 160~400 450 | 6.8~680 | -40 to +105 -25 to +105 | 10,000~12,000 | |
| | RHD | High reliability, 125°C | 10~250 350~450 | 0.47~1,000 | -40 to +125 -25 to +125 | 2,000 | |
| | RHJ | High reliability,130°C | 10~250 350~450 | 1.8~4,700 | -40 to +130 -25 to +130 | 2,000~3,000 | |
| | RHL | Long life,20000hrs (ask engineering bulletin detail) | 400~450 | 6.8~120 | -25 to +105 | 15,000~20,000 | |
| | RHM | On the basis of RHK series ripple promotion product | 160~400 450~460 | 10~150 | -40 to +105 -25 to +105 | 5,000 | |

Aluminum Electrolytic Capacitor – Radial Type

| Category | Series | Description | Voltage | | Capacitance Range (µF) | Temperature Range (°C) | Load Life (hrs) | AEC-Q200 compliant |
|---------------|---------------|--|--------------------|------------------------|----------------------------|------------------------|-----------------|--------------------|
| | | | Rated Voltage (V) | Capacitance Range (µF) | | | | |
| For Ballast | RHE | For ballast, 3000hrs | 160~400 450 | 1~220 | -40 to +105 -25 to +105 | 3,000 | | |
| | RHF | For ballast, 5000hrs | 160~400 450 | 1~220 | -40 to +105 -25 to +105 | 5,000 | | |
| | RHH | For ballast, 10000hrs | 160~450 | 1~220 | -25 to +105 | 10,000 | | |
| Low Impedance | RLA | Low impedance | 6.3~400 450 | 0.47~15,000 | -40 to +105 -25 to +105 | 2,000 | | |
| | RLK | High voltage, High ripple current | 400 450~500 | 10~150 | -40 to +105 -25 to +105 | 2,000 | | |
| | RLB | Low impedance, high ripple current | 6.3~400 450 | 1~15,000 | -40 to +105 -25 to +105 | 2,000~3,000 | | |
| | RLC | Low impedance, high ripple current, than RLB series | 6.3~400 450 | 1~15,000 | -40 to +105 -25 to +105 | 2,000~5,000 | | |
| | RLD | Lower impedance | 6.3~100 | 5.6~18,000 | -40 to +105 | 4,000~8,000 | | |
| | RLE | Lower impedance, high ripple current | 6.3~50 | 22~6,800 | -40 to +105 | 2,000~5,000 | | |
| | RLM | Lower impedance, high ripple current | 10~50 | 100~2,700 | -40 to +105 | 4,000~5,000 | | |
| | RLF | Lower impedance, high ripple current, than RLE series | 6.3~35 | 47~8,200 | -40 to +105 | 5,000~6,000 | | |
| | RLG | Low impedance, high ripple current, long life 10000hrs | 6.3~100 | 6.8~18,000 | -40 to +105 | 4,000~10,000 | | |
| | RLJ | Higher ripple current, long life 10000hrs | 6.3~100 | 5.6~18,000 | -40 to +105 | 6,000~10,000 | | |
| | RLO | On the basis of RLA series ripple promotion product | 400-500 | 4.7-100 | -40 to +105 | 3,000 | | |
| | RLN | 125°C , Low ESR, 30G Vibration resistance | 10~100 | 220~8200 | -40 to +125 | 4000~5000 | ● | |
| | Non-Polarized | RNC | Standard, 85°C | 6.3~100 | 0.1~6,800 | -40 to +85 | 2,000 | |
| RND | | Standard, 105°C | 6.3~160 | 0.1~1,000 | -40 to +105 | 2,000 | | |
| RNE | | Horizontal deflection current correction use | 25, 35, 50, 100 | 2.2~10 | -40 to +105 | 1,000 | | |
| Special | RPB | Low Leakage current, 85°C | 6.3~100 | 0.1~4,700 | -40 to +85 | 2,000 | | |
| | RPC | Low Leakage current, 105°C | 6.3~100 | 0.1~4,700 | -40 to +105 | 1,000 | | |
| | RPD | For permissible abnormal voltage | 200, 400 | 22~470 | -25 to +105 | 2,000 | | |
| | RPE | For audio equipment, 105°C | 6.3~100 | 1~10000 | -40 to +105 | 2,000 | | |

Aluminum Electrolytic Capacitor – Anhydrous Type

| Series | INX Series | Applications | Rated Voltage(V) | Capacitance Range(µF) | Temperature Range(°C) | Load Life (hrs) | AEC-Q200 compliant |
|-----------|------------|--|--------------------|-----------------------|----------------------------|-----------------|--------------------|
| Anhydrous | ATA | Low impedance standard | 6.3~100 160~400 | 0.47~15,000 | -55 to +105 -40 to +105 | 2,000 | ● |
| | ATB | Lower impedance | 6.3~50 63~100 | 5.6~18,000 | -55 to +105 -40 to +105 | 4,000~8,000 | ● |
| | ATC | Lower impedance, high ripple current | 6.3~50 | 22~6,800 | -55 to +105 | 2,000~5,000 | ● |
| | ATD | Low impedance, high ripple current, long life 10000hrs | 6.3~50 63~100 | 6.8~18,000 | -55 to +105 -40 to +105 | 4,000~10,000 | ● |
| | ATE | High voltage, long life, 5000hrs | 160~400 | 2.2~120 | -25 to +105 | 3,000~5,000 | ● |

Remark: Water content of Anhydrous Type
Low voltage:<1%
High voltage:<5%
Water content of electrolyte

Aluminum Electrolytic Capacitor – Snap-in Type

| Series | INX Series | Applications | Rated Voltage(V) | Capacitance Range(uF) | Temperature Range(°C) | Load Life (hrs) | AEC-Q200 compliant |
|--------------|------------|---|-------------------|-----------------------|----------------------------|-----------------|--------------------|
| Snap-in Type | SIA | Standard, 85°C | 10~100 160~500 | 47~68,000 | -40 to +85 -25 to +85 | 2,000 | |
| | SIC | Standard, 105°C | 10~250 350~500 | 68~68,000 | -40 to +105 -25 to +105 | 2,000 | |
| | SID | Long life 3000hrs | 16~250 350~450 | 47~47,000 | -40 to +105 -25 to +105 | 3,000 | |
| | SIE | Long life 5000hrs | 10~100 160~450 | 82~47,000 | -40 to +105 -25 to +105 | 5,000 | • |
| | SIG | Long life 10000hrs | 200~450 | 220~1800 | -25 to +105 | 10,000 | |
| | SIF | For over voltage vent operation test | 200, 400, 420 | 33~1,200 | -25 to +105 | 2,000 | |
| | SIH | Standard, 85°C | 10~100 160~500 | 47~68,000 | -40 to +85 | 3000 | |
| | SIJ | Standard, 85°C | 10~100 160~500 | 47~68,000 | -40 to +85 | 5000 | |
| | SIK | Snap-in Type. For audio equipment,105°C | 16~250 400~450 | 56~33000 | -40 to +105 -25 to +105 | 2000 | |

Aluminum Electrolytic Capacitor – Screw Terminal Type

| Series | INX Series | Applications | Rated Voltage(V) | Capacitance Range(uF) | Temperature Range(°C) | Load Life (hrs) | AEC-Q200 compliant |
|----------------|------------|--------------------------|-------------------|-----------------------|----------------------------|-----------------|--------------------|
| Screw Terminal | STA | Standard, 85°C | 16~250 350~500 | 470~500,000 | -40 to +85 -25 to +85 | 3,000 | |
| | STC | 85°C High ripple current | 350~500 | 1,000~150,000 | -25 to +85 | 5,000 | |
| | STD | 85°C High voltage | 500~650 | 470~500,000 | -25 to +85 | 5,000 | |
| | STE | 85°C Long life 10,000hrs | 350~450 | 1,000~15,000 | -25 to +85 | 10,000 | |
| | STB | Long life, 105°C | 10~100 160~450 | 220~1,000,000 | -40 to +105 -25 to +105 | 2,000~5,000 | |

Aluminum Electrolytic Capacitor – LUG Terminal Type

| Series | INX Series | Applications | Rated Voltage(V) | Capacitance Range(uF) | Temperature Range(°C) | Load Life (hrs) | AEC-Q200 compliant |
|--------------|------------|-----------------|-------------------|-----------------------|----------------------------|-----------------|--------------------|
| LUG Terminal | LTC | Standard, 85°C | 16~250 315~450 | 68~150,000 | -40 to +85 -25 to +85 | 2,000 | |
| | LTD | Standard, 105°C | 16~250 315~450 | 22~10,000 | -40 to +105 -25 to +105 | 2,000 | |

Electrolytic Capacitors - Application Guide

Conductive Polymer Hybrid Aluminum Electrolytic Capacitors

- BASIC STRUCTURE**

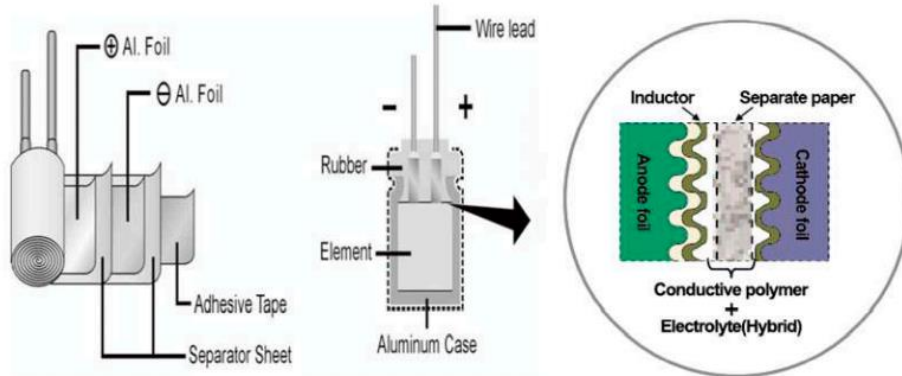

- MANUFACTURING METHOD**

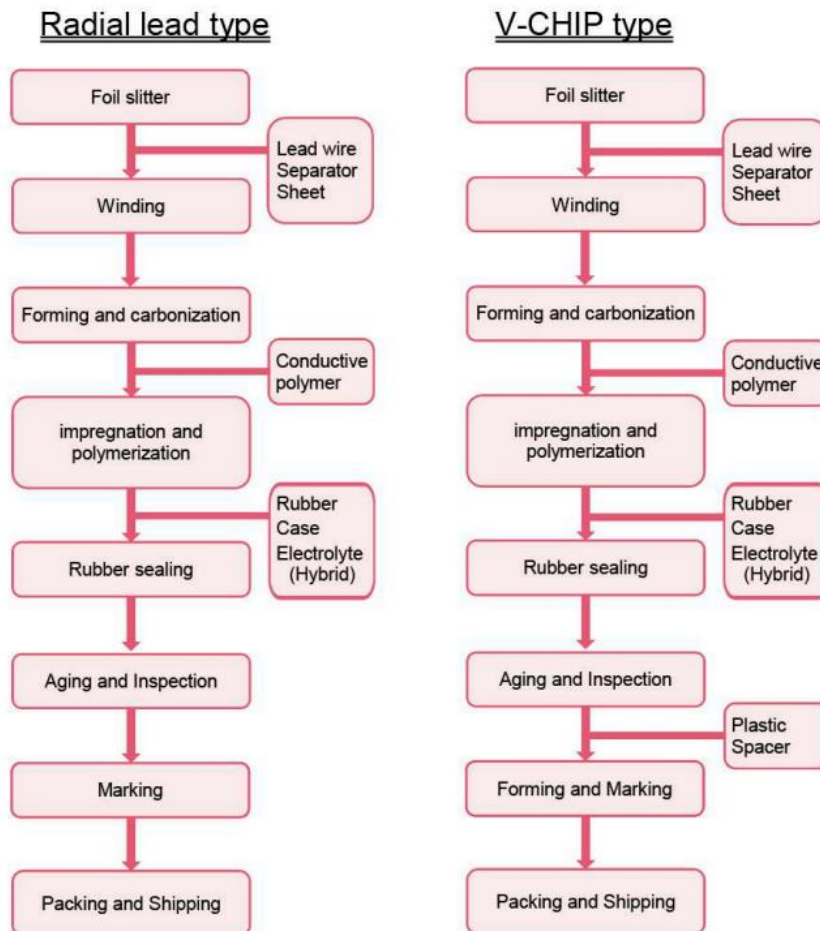

Electrolytic Capacitors - Application Guide

Conductive Polymer Aluminum Solid Capacitors

- BASIC STRUCTURE**

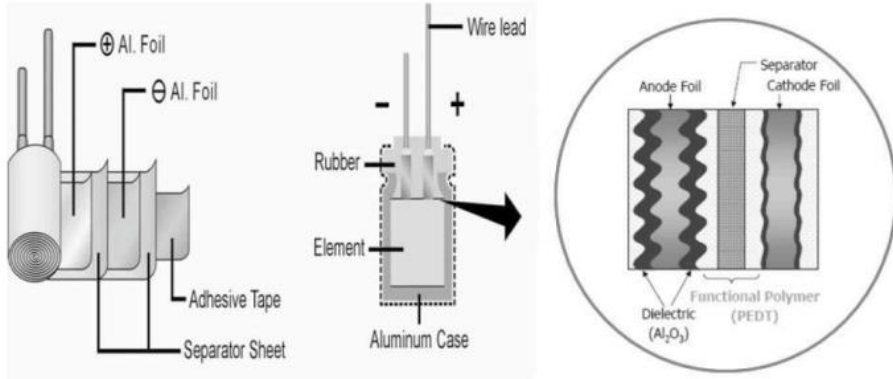

- MANUFACTURING METHOD**

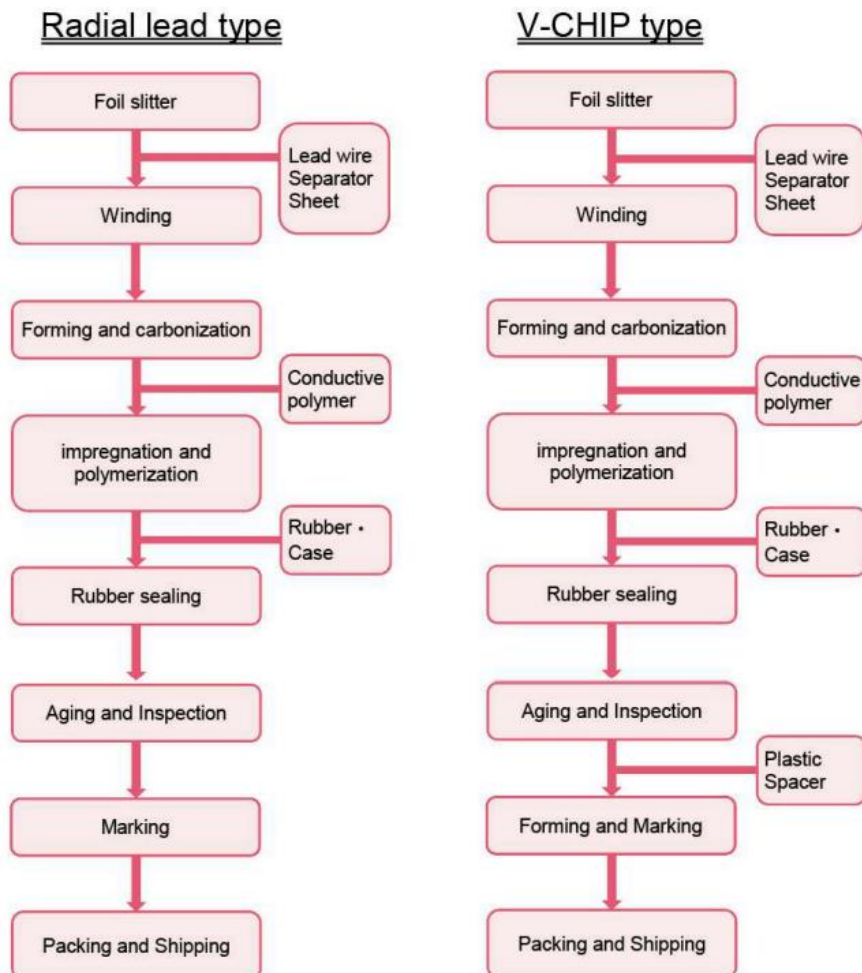

Aluminum Electrolytic Capacitor

Explanation of Part Numbers

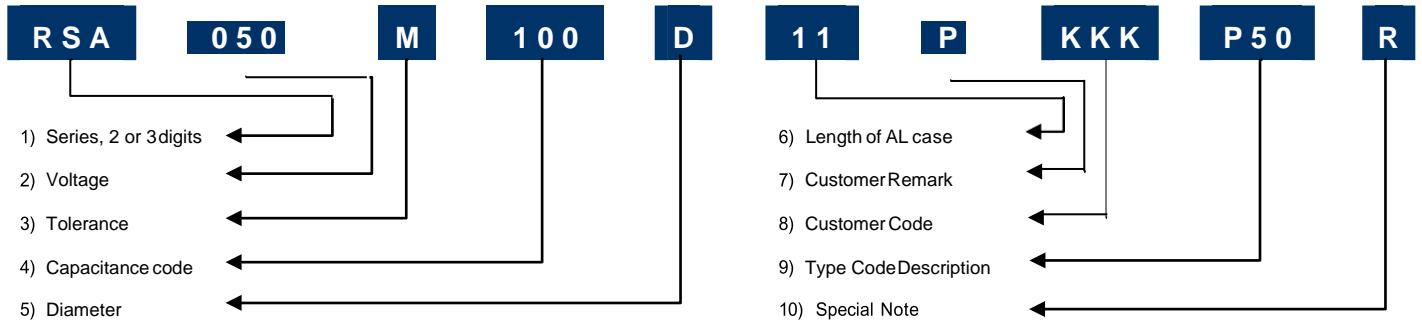

1) **Series Code:** for details please view "Series Index" table (page 2,3,4)

2) **Voltage Code:**

| | | | | | | | | | | | |
|--------------------|-----|-----|-----|-----|-----|-----|-----|-----|-----|-----|-----|
| Voltage (V) | 4 | 6.3 | 10 | 16 | 25 | 35 | 50 | 63 | 80 | 100 | 160 |
| Code | 004 | 006 | 010 | 016 | 025 | 035 | 050 | 063 | 080 | 100 | 160 |
| Voltage (V) | 180 | 200 | 250 | 315 | 330 | 350 | 400 | 420 | 450 | 500 | |
| Code | 180 | 200 | 250 | 315 | 330 | 350 | 400 | 420 | 450 | 500 | |

3) **Capacitance Tolerance:**

| | | | | | | | | | | | | |
|----------------------|-----------|-----------|-----------|-----------|-----------|-----------|-----------|---------|----------|------------|------------|-----------|
| Tolerance (%) | -5 / +15 | +/- 10 | +/- 20 | -0 / +20 | -0 / +40 | -0 / +50 | -5 / +20 | +/- 5 | -5 / +10 | -25 / +20 | -10 / +30 | -20 / +50 |
| Code | C | K | M | A | S | R | D | J | H | L | F | W |
| Tolerance (%) | -10 / +20 | -10 / +30 | -10 / +50 | -15 / +20 | -30 / +20 | +10 / +30 | +10 / +25 | -20 / 0 | -5 / +20 | -20 / +100 | -6.5 / +20 | -40 / +0 |
| Code | V | Q | T | E | I | B | N | G | P | X | Y | O |

4) **Capacitance Code:**

| | | | | | | | | |
|-------------------------|-----|-----|-----|-----|------|-------|--------|-------|
| Capacitance (µF) | 0.1 | 1 | 10 | 100 | 1000 | 10000 | 100000 | 22000 |
| Code | OR1 | 1R0 | 100 | 101 | 102 | 103 | 104 | 223 |

5) **Diameter:**

| | | | | | | | | | | | | | | | | | |
|----------------------|-----|----|----|-----|----|----|----|------|----|------|-----|-----|------|------|----|-----|-----|
| Diameter (mm) | 100 | 4 | 5 | 6.3 | 8 | 10 | 12 | 12.5 | 13 | 14.5 | 16 | 18 | 42 | 14 | 21 | 7.5 | 5.5 |
| Code | B | C | D | E | F | G | H | X | I | Y | J | K | W | 1 | 3 | 7 | 5 |
| Diameter (mm) | 20 | 22 | 25 | 30 | 35 | 40 | 51 | 64 | 76 | 90 | 6.5 | 5.2 | 25.4 | 15.5 | 33 | 45 | |
| Code | L | M | N | O | P | Q | R | S | T | U | V | A | Z | 2 | 4 | 8 | |

6) **Length rule for Aluminum case:** Length <100mm **Integer**, use length(mm) directly. Ex: 35mm is 35 (For other lengths, refer below "Note").

****TABLE**:**

| | | | | | | | | | | | | | | |
|--------------------|-----|-----|-----|-----|-----|-----|-----|-----|-----|----|----|----|----|----|
| Value | 10 | 11 | 12 | 13 | 14 | 15 | 16 | 17 | 18 | 19 | 20 | 35 | 22 | 31 |
| First Code | A | B | C | D | E | F | G | H | I | J | K | L | M | N |
| Value | 0.4 | 0.5 | 0.6 | 0.7 | 0.8 | 0.9 | 0.1 | 0.2 | 0.3 | | | | | |
| Second Code | A | B | C | D | E | F | G | H | I | | | | | |

Note:

- Length <100mm **Decimal**, refer ****TABLE****. Ex: 12.5 is CB
- Length ≥100mm, refer ****TABLE****. Ex: 115 is B5, 224 is M4, 136 is D6

7) **Customer Remark:** to define customizations and special customer needs

8) **Customer code:** for customization of product, can be modified based on customer request (standard is KKK)

9) **Type code description:**

A: Radial & V-Chip code: 1st letter for processing method, 2nd & 3rd refer to sheet "Lead cutting & forming" (page 245)

| | | | | | | |
|--------------------|------------------------|------------------------|--------------------|------------------------|-----------------------|---------|
| Description | Long Lead | Lead cut | Lead cut & crimp | Lead cut, crimp & form | Lead cut & form (5mm) | Forming |
| Code | S** | C* | D* | H* | F* | B** |
| Description | Lead cut & bending (+) | Lead cut & bending (-) | Taping (Ammo pack) | Tape & Reel | V-Chip type (SMD) | |
| Code | Z* | L* | P*** | R* | V* | |

- * : 2nd and 3rd letter should be lead length
- ** : 2nd and 3rd letter should be "00"
- *** : 2nd and 3rd letter should be lead pitch

B: Terminal Diagram Code for Snap-in, LUG & Screw Terminal Type

| | | | | | | | | | | |
|--------------------|-----------------------|------------------------|------------------|------------------------|------------------------------------|-------------------------------|------------------------------------|--------------------------------|-------------------------|----------------|
| Description | Snap-In long terminal | Snap-In short terminal | LG Type terminal | Straight Type terminal | PC board pin-out straight terminal | PC board pin-out LUG terminal | PC board pin-out U-insert terminal | PC board pin-out bend terminal | 5 pin straight terminal | screw terminal |
| Code | YL | YS | G | ST | PCS | PCY | PCU | PCB | U | W |

10) **Special Note :** R: Commercial and RoHS compliant
A: Automotive and RoHS compliant

Precautions in Using (Solid & Hybrid)



Precautions for circuit designing

1. Polarity

Conductive Polymer Aluminum Electrolytic Capacitors have the positive and negative electrodes. Using reversed polarity may cause leakage current increased or life span decreased.

2. Prohibited circuits

Conductive Polymer Aluminum Electrolytic Capacitors leakage current may become larger as the following conditions.

- (a) Soldering
- (b)) High temperature no-load test, high temperature and high humidity no-load test, rapidly changing temperature test, etc.

Avoid the use of Conductive Polymer Aluminum Electrolytic Capacitors in the following type of circuits because leakage current may increase.

- (a) High-impedance circuits
- (b)) Coupling circuits
- (c) Time constant circuits
- (d)) Other circuits that are significantly affected by leakage current

▲ If you plan to use 2 or more Conductive Polymer Aluminum Electrolytic Capacitors in a series connection, please contact us before use.

3. Circuit Design

Verify the following before designing the circuit:

- (a) The electrical characteristics of the capacitor will vary depending on differences in temperature and frequency. Only Design after verifying the scope of these factors.
- (b)) When connecting two or more capacitors in parallel ensure that the design takes current balancing into account.
- (c) When two or more capacitors are connected in series, variability in applied voltage may cause over-voltage conditions. Contact Infinex before using capacitors connected in series.

4. Operating temperature voltages and ripple current

- (a) Operating temperature must be under the category temperature range of specification.
- (b)) Do not apply voltages exceeding the full rated voltage.
- (c) Do not apply currents that exceed the rated ripple current.

When excessive ripple current is applied, the Conductive Polymer Aluminum Electrolytic Capacitors may result in shorter life due to the internal heat increase.

1. Sudden charge and discharge

An excessive surge current by sudden charge or discharge may result in a short circuit or a large leakage current. Protection circuits are recommended to retain high reliability in case of the following conditions.

- (a) The surge current value exceeds 10A
- (b) The value exceeds 10 times of the rated ripple current

▲ When you measure leakage current, a protection resistor of approximately 1k Ω must be inserted to the circuit before charge and discharge.

2. Failure

The failure rate is 0.5% / 1000h (with a 60% reliability standard) based on JIS C 5003.
The mainly failure modes are as follows.

6-1. Contingency failure

1.The product of electrostatic capacitance decrease caused by temperature rise and the rise of the ESR open mode caused by the wear. that is the main failure mode. Sometimes accidental short-circuit caused by excessive voltage and large current mode

2. Decrease the failure rate we can reduce ambient temperature, ripple current and use voltage.

3.When the load voltage exceeds the rated voltage will cause a short circuit or ripple current is too large, internal pressure increased and the rubber expansion or peeling, smelliness

4. The installation method of products, Position, Graphic design please consider the following points to ensure the safety A. Set the protection circuit and Protector to ensure the safety.

B. Setting a redundant circuit, so that the equipment will not be unstable because of a single fault.

6-2. Wear-out failure (life-span)

When life span exceeded the specified guarantee time of Endurance and Damp heat, electrolyte might insulate and cause electric characteristic changed. This is called an open circuit. The electric characteristics of capacitance and ESR may possibly change within the specified range in specifications when it is used under the condition of the rated voltage, electric and mechanical performance. Please note it when design.

Lifetime (hours)of the capacitor to be estimated:

A: $Lx=Lo \times 10^{(To -Tx) / 20}$ B: $Lx = Lo \times 2^{(To-Tx)/10}$

Lifetime (hours) of the capacitor to be estimated (15 Years Life is Maximum)

Base lifetime (hours) of the capacitor

Actual ambient temperature (°C) of the capacitor

| A | B |
|--|--|
| PRA,PRB,PRC,PRD,PRF, PSA,PSB,PSC,PSD,PSE,PSF | PRH,PRG,PSG,PSH is similar To the lifetime estimation of Al Electrolytic capacitor |
| 105°C ≥ 2,000hrs | 105°C ≥ 2,000hrs |
| 95°C ≥ 6,324hrs | 95°C ≥ 4,000 hrs |
| 85°C ≥ 20,000hrs | 85°C ≥ 8,000 hrs |
| 75°C ≥ 63,245hrs | 75°C ≥ 16,000hrs |

▪ **Caution For Assembling Capacitors**

1. Leakage Current

Mechanical stress may cause Conductive Polymer Aluminum Electrolytic Capacitors leakage current increased. In such a case, leakage current will gradually decrease by applying voltage within the category voltage and the upper category temperature. Then, self-healing speed of leakage current is faster when it is near to the upper category temperature and the category voltage.

The cause of Leakage current rise again

- a. soldering
- b. High Temp shelf, High Temp High Humidity and Temp rapid change etc.

2. Capacitor insulation

(a) The space between the case and the negative electrode terminal is insulated and has some resistance.

(b)) Be sure to completely separate the case, negative lead terminal, positive lead terminal and PC board patterns

3. Operating environmental restrictions

Do not use the Conductive Polymer Aluminum Electrolytic Capacitors in the following environments.

(a) Places where water, salt water or oil can directly fall on it, and places where condensation may form.

(b)) Places filled with noxious gas (hydrogen sulfide, sulfurous acid, nitrous acid, chlorine, ammonia, etc.)

(c) Places susceptible to ozone, ultraviolet rays and radiation

4. PCB design

(a) Avoid locating heat-generating components around the Conductive Polymer Aluminum Electrolytic Capacitors and on the underside of the PC board.

(b) For the surface mount capacitor, design the copper pads on the PC board in according with the recommended land pattern or dimensions in the series specifications.

(c) For radial capacitor, design the terminal pitch and hole size after conforming the dimensional tolerance in the series specifications.

5. Parallel connection

A large amount of ripple current may be applied to the Conductive Polymer Aluminum Electrolytic Capacitors when it is used in parallel with another capacitor. Carefully select the type of capacitor.

6. Others

Design circuits after checking the following items.

(a) Electric characteristics are affected by temperature or frequency fluctuations. Design circuits after checking the changes.

(b)) When mounting a Conductive Polymer Aluminum Electrolytic Capacitors on a double-sided PC board, extra PC board holes or through holes for connecting the front and back of the PCB must not exist underneath the Conductive Polymer Aluminum Electrolytic Capacitors.

▪ **Precautions for mounting on-board**

1. Considerations when soldering

The soldering conditions as soldering iron, flow soldering, reflow soldering should be under the range prescribed in specifications. If the specifications are not followed, there is a possibility of the cosmetic deflection, the intensive increase of leakage current or the capacitance reduction.

2. Capacitor insulation

(a) Do not reuse Conductive Polymer Aluminum Electrolytic Capacitors that have been assembled in a set and energized. Excluding Conductive Polymer Aluminum Electrolytic Capacitors that have been removed for measuring electrical characteristics during a periodic inspection, Conductive Polymer Aluminum Electrolytic Capacitors cannot be reused.

(b) Leakage current may increase when Conductive Polymer Aluminum Electrolytic Capacitors are stored for long term. In this case, we

recommend that you apply the rated voltage for 1 hour at 60°C~70°C with a resistor load of 1kΩ.

3. Mounting-1

(a) Mount after checking the capacitance and the rated voltage.

(b) Do not drop Conductive Polymer Aluminum Electrolytic Capacitors on the floor and do not use it that is dropped.

(c) Do not mount Conductive Polymer Aluminum Electrolytic Capacitors that is deformed.

(d) Do not break aluminum case surface coating in mounting

4. Mounting-2

(a) Avoid locating heat-generating components around the Conductive Polymer Aluminum Electrolytic Capacitors and on the underside of the PC board.

(b) For the surface mount capacitor, design the copper pads on the PC board in according with the recommended land pattern or dimensions in the series specifications.

(c) For radial capacitor, design the terminal pitch and hole size after conforming the dimensional tolerance in the series specifications.

5. Soldering with a soldering iron

(a) Soldering condition should be under the following ranges.

| Conditions | Soldering iron temperature | Time |
|---------------------|----------------------------|------------|
| Soldering condition | 380±10°C | within 5s. |

(b)) When the lead terminal for radial lead type must be processed because the lead pitch and the PCB holes in spacing do not match, process it without any stresses to Conductive Polymer Aluminum Electrolytic Capacitors.

(c) Solder without any excessive stresses to Conductive Polymer Aluminum Electrolytic Capacitors itself.

(d)) When Conductive Polymer Aluminum Electrolytic Capacitors has been soldered once and needs to be removed, remove it after the solder has been completely melted.

(e)) Do not let the tip of the soldering iron touch the Conductive Polymer Aluminum Electrolytic Capacitors itself.

6. Flow soldering

(a) Soldering condition should be under the following ranges.

Recommended flow soldering condition

| Conditions | Temperature | Time | Flow number |
|----------------------|-------------------------------------|---------------------|--------------------|
| Preheating | 120°C or less (ambient temperature) | 120 sec. or less | 1 time |
| Soldering conditions | 260 + 5°C or less | 10 + 1 sec. or less | 2 times or less ※1 |

※1. When soldering 2 times, immersion time should be 10 + 1 sec. or less.

(b) Do not apply flow soldering to SMD type.

(c) Do not solder Conductive Polymer Aluminum Electrolytic Capacitors itself by submerging it in melted solder. Solder the opposite side that the Conductive Polymer Aluminum Electrolytic Capacitors is mounted on.

(d) Note that flux does not adhere to anywhere except the lead terminal.

(e) Note that other components do not fall over and touch the Conductive Polymer Aluminum Electrolytic Capacitors when soldering.

7. Reflow soldering

(a) Soldering condition should be under the following ranges.

Recommended reflow soldering condition

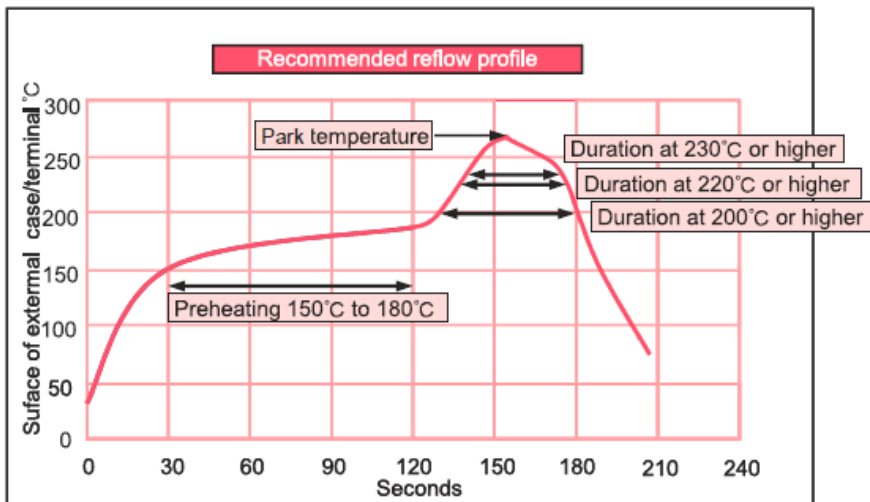

※All temperatures are measured on the topside of the Al-can and terminal surface

(b) Conductive Polymer Hybrid Aluminum Electrolytic Capacitors

| Voltage Range(V) | 16~63 | 80~125 |
|-----------------------------|-------------------|-------------------|
| Peak Temperature | 260°C, 5sec. max. | 250°C, 5sec. max. |
| Preheat Temperature | 120 sec. max. | 120 sec. max. |
| Duration at 200°C or higher | 100 sec. max. | 100 sec. max. |
| Duration at 220°C or higher | 80 sec. max. | 80 sec. max. |
| Duration at 230°C or higher | 40 sec. max. | 40 sec. max. |
| Reflow number | twice or less | twice or less |

(c) Conductive Polymer Aluminum Solid Capacitors

| Item | Polymer | |
|-----------------------------|----------------------|---------------|
| | Peak Temperature | 250°C or less |
| Preheat Temperature | 150°C~180°C 90±3sec. | |
| Duration at 200°C or higher | 60 sec. max. | 60 sec. max. |
| Duration at 220°C or higher | 50 sec. max. | 50 sec. max. |
| Duration at 230°C or higher | 40 sec. max. | 40 sec. max. |
| Reflow number | twice or less | only 1 time |

※Reflow should be performed twice or less. Please ensure that the capacitor became cold enough to the room temperature (5 to 35°C) before the second reflow.

(d) Do not apply reflow soldering to Radial Lead type.

(e) RECOMMENDED LAND PATTEND DIMENSION OFPCB

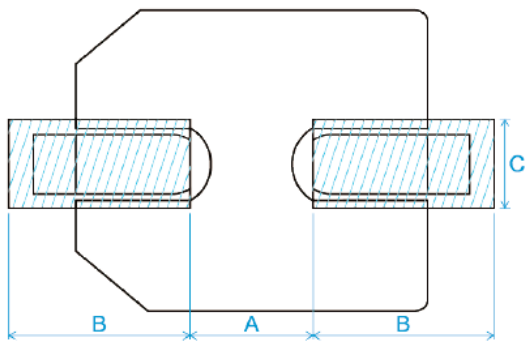

| ØD | a | b | c |
|--------|-----|-----|-----|
| Ø5 | 1.4 | 3.0 | 1.6 |
| Ø6.3 | 1.9 | 3.5 | 1.6 |
| Ø8 | 3.1 | 4.2 | 2.2 |
| Ø10 | 4.5 | 4.4 | 2.2 |
| Ø10(G) | 3.8 | 4.8 | 4.1 |

“(G)” – Anti vibration structure.

8. Handling after soldering

- (a) Do not tilt, bend or twist Conductive Polymer Aluminum Electrolytic Capacitors.
- (b) Do not move the PCB with catching Conductive Polymer Aluminum Electrolytic Capacitors itself.
- (c) When stacking PCBs, make sure that the Conductive Polymer Aluminum Electrolytic Capacitors does not touch other PCBs or components.
- (d) Do not dump the Conductive Polymer Aluminum Electrolytic Capacitors with objects.

9. Cleaning PCB

Check the following items before washing PC board with these detergents: high quality alcohol-based cleaning fluid such as Pine- α ST-100S, clean thru 750H, 750L, 710M, 750K or Techno Care FRW 14 through 17 or detergents including substitute Freon as AK-225AES or IPA.

- (a) Use immersion or ultrasonic waves to clean within 2 minutes on polymer conductive type.
- (b) The temperature of the cleaning fluid should be less than 60°C.
- (c) Watch the contamination of the detergent as conductivity, ph, specific gravity, water content, etc.
- (d) Do not store the Conductive Polymer Aluminum Electrolytic Capacitors in a location subject to gases from the cleaning fluid or in an airtight container after cleaning.
- (e) Dry the PCB or Conductive Polymer Aluminum Electrolytic Capacitors with hot air that should be less than the maximum operating temperature. Please note that Indication may disappear when rubbing print side after washing as a cleaner.
- (f) Please contact us for details about detergents, cleaning methods and about detergents other than those listed above.

10. Fixatives and coating materials

- (a) Select the appropriate covering and sealant materials for Conductive Polymer Aluminum Electrolytic Capacitors. In particular, make sure the fixative, coating and thinner do not contain acetone.
- (b) Before applying a fixative or coating, completely remove any flux residue and foreign matter from the area where the board and Conductive Polymer Aluminum Electrolytic Capacitors will be jointed together.
- (c) Allow any detergent to dry before applying the fixative or coating.
- (d) Please contact us for fixative and coating heat curing conditions.

- **Environmental Consideration**

Compliance with RoHS Directive

| Substance | Symbol | Maximum Limit (ppm) |
|--------------------------------|--------|---------------------|
| Cadmium and Cadmium Compounds | Cd | 100 |
| Lead and Lead Compounds | Pb | 1000 |
| Mercury and Mercury Compounds | Hg | 1000 |
| Hexavalent Chromium Compounds | Cr6+ | 1000 |
| Polybrominated Biphenyls | PBBs | 1000 |
| Polybrominated Diphenyl Ethers | PBDEs | 1000 |
| Dibutyl phthalate | DBP | 1000 |
| Benzyl butyl phthalate | BBP | 1000 |
| Bis(2-Ethylhexyl) phthalate | DEHP | 1000 |
| Diisobutyl phthalate | DIBP | 1000 |

Conductive Polymer Hybrid Aluminum Electrolytic Capacitors

HRA Series

- Low ESR.
- High Voltage, Long Life.
- 105°C, 5,000~10,000hrs.
- RoHS compliant & Halogen Free
- For high reliability applications. (Automotive equipment, Base station equipment, etc.)

Specifications

| Items | Conditions | Characteristics |
|----------------------------|--|---|
| Category Temperature Range | - | -55 to +105°C |
| Rated Voltage Range | - | 16 ~ 125V |
| Capacitance Tolerance | at 20°C, 120 Hz | ±20% (M) |
| Surge Voltage | at 15 ~ 35°C | Rated voltage x 1.15V |
| Leakage Current | at 20°C after 2 minutes | $I \leq 0.01CV$ or $3(\mu A)$ Whichever is greater measured, after 2 minutes application of rated working voltage at +20°C. Please see the attached characteristics list |
| Dissipation Factor (tan δ) | at 20°C, 120 Hz | Please see the attached characteristics list |
| Endurance | The following specifications shall be satisfied when the capacitors are restored to 20°C after the rated voltage is applied for 5,000 to 10,000 hours at 105°C. Φ 6.3=5,000hrs, D ≥ Φ 8=10,000hrs. | Appearance NO significant damage. |
| | | Capacitance change $\leq \pm 30\%$ of the initial value. |
| | | DF (tan δ) $\leq 200\%$ of the initial specified value. |
| | | ESR $\leq 200\%$ of the initial specified value. |
| | | Leakage current \leq The initial specified value. |
| Damp Heag (Steady State) | The following specifications shall be satisfied when the capacitors are restored to 20°C after subjecting them to store at 60°C, 90 to 95% RH for 1,000 hours, without DC applied. | Appearance NO significant damage. |
| | | Capacitance change $\leq \pm 30\%$ of the initial value. |
| | | DF (tan δ) $\leq 200\%$ of the initial specified value. |
| | | ESR $\leq 200\%$ of the initial specified value. |
| | | Leakage current \leq The initial specified value. |
| Surge Voltage | The capacitors shall be subjected to 1,000 cycles each consisting of charge with the surge voltages specified at 15~35°C for 30 seconds through a protective resistor (R = 1 kΩ) and discharge for 5 minutes 30 seconds. | Appearance NO significant damage. |
| | | Capacitance change $\leq \pm 30\%$ of the initial value. |
| | | DF (tan δ) $\leq 200\%$ of the initial specified value. |
| | | ESR $\leq 200\%$ of the initial specified value. |
| | | Leakage current \leq The initial specified value. |

※ Note: If any doubt arises, measure the leakage current after following voltage treatment.
Voltage treatment: DC rated voltage are applied to the capacitors for 120 minutes at 105°C.

Frequency Coefficient of Permissible Ripple Current

| Capacitance (μF) | Frequency (Hz) | | | |
|------------------|----------------|--------------|----------------|----------|
| | 100 ≤ F < 1K | 1K ≤ F < 10K | 10K ≤ F < 100K | 100K ≤ F |
| 4.7 < C ≤ 33 | 0.05 | 0.32 | 0.67 | 1.00 |
| 33 < C | 0.10 | 0.35 | 0.70 | 1.00 |

Dimensions

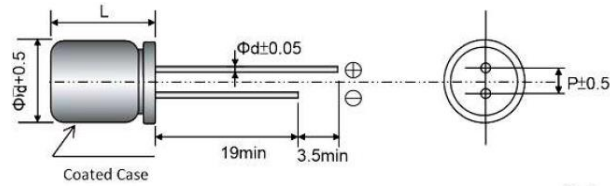

(UNIT: mm)

| Size (ΦDxL) | 6.3x7.2 | 8x9.5 | 10x9.5 | 10x11.5 |
|-------------|-----------|-----------|-----------|-----------|
| ΦD | 6.3 | 8.0 | 10 | 10 |
| L | L+1.5 max | L+1.5 max | L+1.5 max | L+1.5 max |
| Φd | 0.5 | 0.6 | 0.6 | 0.6 |
| P | 2.5 | 3.5 | 5.0 | 5.0 |

HRA SERIES STANDARD CHARACTERISTICS LIST

| Rated Voltage (S.V.) | Cap (μF) | Size DxL | Leakage current (μA) max. | ESR (mΩ) max. 100k to 300 KHz / 20°C | Rated Ripple Current (mA rms) 100 KHz / 105°C | D.F. (tanδ) max. 120 Hz / 20°C |
|----------------------|----------|----------|---------------------------|--------------------------------------|---|--------------------------------|
| 16 (18.4) | 120 | 6.3x7.2 | 19 | 40 | 1,500 | 0.16 |
| | 270 | 8x9.5 | 43 | 26 | 2,000 | 0.16 |
| | 470 | 10x9.5 | 75 | 21 | 2,600 | 0.16 |
| | 560 | 10x11.5 | 90 | 15 | 3,000 | 0.16 |
| 25 (28.8) | 68 | 6.3x7.2 | 17 | 45 | 1,400 | 0.16 |
| | 150 | 8x9.5 | 38 | 27 | 1,900 | 0.16 |
| | 270 | 10x9.5 | 68 | 22 | 2,500 | 0.16 |
| 35 (40.3) | 330 | 10x11.5 | 83 | 16 | 2,900 | 0.16 |
| | 47 | 6.3x7.2 | 16 | 60 | 1,300 | 0.16 |
| | 100 | 8x9.5 | 35 | 30 | 1,800 | 0.16 |
| 40 (46) | 150 | 10x9.5 | 53 | 23 | 2,400 | 0.16 |
| | 220 | 10x11.5 | 77 | 17 | 2,800 | 0.16 |
| | 27 | 6.3x7.2 | 11 | 70 | 1,200 | 0.16 |
| | 56 | 8x9.5 | 22 | 32 | 1,700 | 0.16 |
| 50 (57.5) | 100 | 10x9.5 | 40 | 24 | 2,400 | 0.16 |
| | 120 | 10x11.5 | 48 | 18 | 2,700 | 0.16 |
| | 15 | 6.3x7.2 | 8 | 80 | 1,200 | 0.16 |
| | 33 | 8x9.5 | 17 | 35 | 1,600 | 0.16 |
| 63 (72.5) | 56 | 10x9.5 | 28 | 25 | 2,300 | 0.16 |
| | 82 | 10x11.5 | 41 | 19 | 2,600 | 0.16 |
| | 10 | 6.3x7.2 | 6 | 100 | 1,000 | 0.16 |
| | 22 | 8x9.5 | 14 | 40 | 1,500 | 0.16 |
| | 33 | 8x9.5 | 21 | 40 | 1,500 | 0.16 |
| 80 (92) | 10x9.5 | 21 | 30 | 2,100 | 0.16 | |
| | 47 | 10x9.5 | 30 | 30 | 2,100 | 0.16 |
| | 56 | 10x11.5 | 35 | 22 | 2,400 | 0.16 |
| | 12 | 10x9.5 | 10 | 70 | 1,600 | 0.16 |
| | 15 | 10x9.5 | 12 | 70 | 1,600 | 0.16 |
| 100 (115) | 18 | 10x11.5 | 14 | 50 | 1,800 | 0.16 |
| | 10 | 10x9.5 | 10 | 80 | 1,400 | 0.16 |
| | 12 | 10x9.5 | 12 | 80 | 1,400 | 0.16 |
| 125 (143.8) | 15 | 10x11.5 | 15 | 60 | 1,600 | 0.16 |
| | 10 | 10x9.5 | 13 | 90 | 1,200 | 0.16 |

Conductive Polymer Hybrid Aluminum Electrolytic Capacitors

HRB Series

- Low ESR.
- High Voltage, Long Life.
- 125°C, 2,000~4,000hrs.
- RoHS Compliant & Halogen Free
- For automotive modules and other high temperature applications

Specifications

| Items | Conditions | Characteristics |
|----------------------------|--|---|
| Category Temperature Range | - | -55 to +125°C |
| Rated Voltage Range | - | 16 ~ 50V |
| Capacitance Tolerance | at 20°C, 120 Hz | ±20% (M) |
| Surge Voltage | at 15 ~ 35°C | Rated voltage x 1.15V |
| Leakage Current | at 20°C after 2 minutes | $I \leq 0.01CV$ or $3(\mu A)$ Whichever is greater measured, after 2 minutes application of rated working voltage at +20°C. Please see the attached characteristics list |
| Dissipation Factor (tan δ) | at 20°C, 120 Hz | Please see the attached characteristics list |
| Endurance | The following specifications shall be satisfied when the capacitors are restored to 20°C after the rated voltage is applied for 2,000 to 4,000 hours at 125°C. Φ 6.3=2,000hrs, D ≥ Φ 8=4,000hrs. | Appearance NO significant damage. |
| | | Capacitance change $\leq \pm 30\%$ of the initial value. |
| | | DF (tan δ) $\leq 200\%$ of the initial specified value. |
| | | ESR $\leq 200\%$ of the initial specified value. |
| | | Leakage current \leq The initial specified value. |
| Damp Heag (Steady State) | The following specifications shall be satisfied when the capacitors are restored to 20°C after subjecting them to store at 60°C, 90 to 95% RH for 1,000 hours, without DC applied. | Appearance NO significant damage. |
| | | Capacitance change $\leq \pm 30\%$ of the initial value. |
| | | DF (tan δ) $\leq 200\%$ of the initial specified value. |
| | | ESR $\leq 200\%$ of the initial specified value. |
| | | Leakage current \leq The initial specified value. |
| Surge Voltage | The capacitors shall be subjected to 1,000 cycles each consisting of charge with the surge voltages specified at 15~35°C for 30 seconds through a protective resistor (R = 1 kΩ) and discharge for 5 minutes 30 seconds. | Appearance NO significant damage. |
| | | Capacitance change $\leq \pm 30\%$ of the initial value. |
| | | DF (tan δ) $\leq 200\%$ of the initial specified value. |
| | | ESR $\leq 200\%$ of the initial specified value. |
| | | Leakage current \leq The initial specified value. |

※ Note : If any doubt arises, measure the leakage current after following voltage treatment.
Voltage treatment : DC rated voltage are applied to the capacitors for 120 minutes at 125°C.

Frequency Coefficient for Ripple Current

| Capacitance (μF) | Frequency (Hz) | | | |
|------------------|----------------|--------------|----------------|----------|
| | 100 ≤ F < 1K | 1K ≤ F < 10K | 10K ≤ F < 100K | 100K ≤ F |
| 4.7 < C ≤ 33 | 0.05 | 0.32 | 0.67 | 1.00 |
| 33 < C | 0.10 | 0.35 | 0.70 | 1.00 |

Dimensions

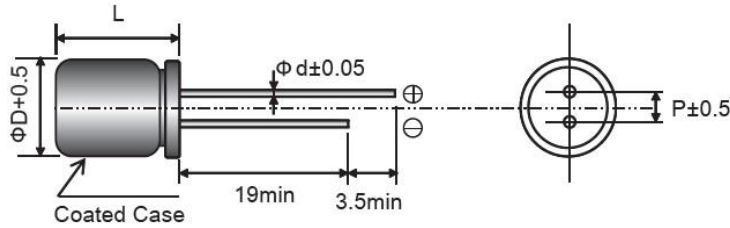

(UNIT: mm)

| Size ($\Phi D \times L$) | 6.3x7.2 | 8x9.5 | 10x9.5 | 10x11.5 |
|----------------------------|-----------|-----------|-----------|-----------|
| ΦD | 6.3 | 8.0 | 10 | 10 |
| L | L+1.5 max | L+1.5 max | L+1.5 max | L+1.5 max |
| Φd | 0.5 | 0.6 | 0.6 | 0.6 |
| P | 2.5 | 3.5 | 5.0 | 5.0 |

HRB SERIES STANDARD CHARACTERISTICS LIST

| Rated Voltage (S.V.) | Cap (μF) | Size DxL | Leakage current (μA) max. | ESR (m Ω) max. 100k to 300 KHz / 20°C | Rated Ripple Current (mA rms) 100 KHz / 125°C | D.F. (tan δ) max. 120 Hz / 20°C |
|----------------------|-----------------|----------|----------------------------------|---|---|---|
| 16 (18.4) | 120 | 6.3x7.2 | 19 | 40 | 1,100 | 0.16 |
| | 270 | 8x9.5 | 43 | 26 | 1,500 | 0.16 |
| | 470 | 10x9.5 | 75 | 21 | 2,000 | 0.16 |
| | 560 | 10x11.5 | 90 | 15 | 2,300 | 0.16 |
| 25 (28.8) | 68 | 6.3x7.2 | 17 | 45 | 1,000 | 0.16 |
| | 150 | 8x9.5 | 38 | 27 | 1,300 | 0.16 |
| | 270 | 10x9.5 | 68 | 22 | 1,500 | 0.16 |
| | 330 | 10x11.5 | 83 | 16 | 1,700 | 0.16 |
| 35 (43.3) | 47 | 6.3x7.2 | 16 | 60 | 900 | 0.16 |
| | 100 | 8x9.5 | 35 | 30 | 1,200 | 0.16 |
| | 150 | 10x 9.5 | 53 | 23 | 1,400 | 0.16 |
| | 220 | 10x11.5 | 77 | 17 | 1,600 | 0.16 |
| 40 (46) | 27 | 6.3x7.2 | 11 | 70 | 900 | 0.16 |
| | 56 | 8x9.5 | 22 | 32 | 1,200 | 0.16 |
| | 100 | 10x9.5 | 40 | 24 | 1,400 | 0.16 |
| | 120 | 10x11.5 | 48 | 18 | 1,600 | 0.16 |
| 50 (57.5) | 15 | 6.3x7.2 | 8 | 80 | 800 | 0.16 |
| | 33 | 8x9.5 | 17 | 35 | 1,100 | 0.16 |
| | 56 | 10x9.5 | 28 | 25 | 1,300 | 0.16 |
| | 82 | 10x11.5 | 41 | 19 | 1,500 | 0.16 |

Conductive Polymer Hybrid Aluminum Electrolytic Capacitors HSA Series

- Low ESR.
- High Voltage, Long Life.
- 105°C, 5,000~10,000hrs.
- RoHS Compliant
- For high reliability applications. (Automotive equipment, Base station equipment, etc.)

Specifications

| Items | Conditions | Characteristics |
|----------------------------|--|---|
| Category Temperature Range | - | -55 to +105°C |
| Rated Voltage Range | - | 16 ~ 125V |
| Capacitance Tolerance | at 20°C, 120 Hz | ±20% (M) |
| Surge Voltage | at 15 ~ 35°C | Rated voltage x 1.15V |
| Leakage Current | at 20°C after 2 minutes | $I \leq 0.01CV$ or $3(\mu A)$ Whichever is greater measured, after 2 minutes application of rated working voltage at +20°C. Please see the attached characteristics list |
| Dissipation Factor (tan δ) | at 20°C, 120 Hz | Please see the attached characteristics list |
| Endurance | The following specifications shall be satisfied when the capacitors are restored to 20°C after the rated voltage is applied for 5,000 to 10,000 hours at 105°C. Φ 6.3=5,000hrs, D ≥ Φ 8=10,000hrs. | Appearance NO significant damage. |
| | | Capacitance change $\leq \pm 30\%$ of the initial value. |
| | | DF (tan δ) $\leq 200\%$ of the initial specified value. |
| | | ESR $\leq 200\%$ of the initial specified value. |
| | | Leakage current \leq The initial specified value. |
| Damp Heat (Steady State) | The following specifications shall be satisfied when the capacitors are restored to 20°C after subjecting them to store at 60°C, 90 to 95% RH for 1,000 hours, without DC applied. | Appearance NO significant damage. |
| | | Capacitance change $\leq \pm 30\%$ of the initial value. |
| | | DF (tan δ) $\leq 200\%$ of the initial specified value. |
| | | ESR $\leq 200\%$ of the initial specified value. |
| | | Leakage current \leq The initial specified value. |
| Surge Voltage | The capacitors shall be subjected to 1,000 cycles each consisting of charge with the surge voltages specified at 15~35°C for 30 seconds through a protective resistor (R = 1 kΩ) and discharge for 5 minutes 30 seconds. | Appearance NO significant damage. |
| | | Capacitance change $\leq \pm 30\%$ of the initial value. |
| | | DF (tan δ) $\leq 200\%$ of the initial specified value. |
| | | ESR $\leq 200\%$ of the initial specified value. |
| | | Leakage current \leq The initial specified value. |

※ Note : If any doubt arises, measure the leakage current after following voltage treatment.
Voltage treatment : DC rated voltage are applied to the capacitors for 120 minutes at 105°C.

Frequency Coefficient for Ripple Current

| Capacitance (μF) | Frequency (Hz) | | | |
|-------------------|-------------------|-------------------|---------------------|---------------|
| | $100 \leq F < 1K$ | $1K \leq F < 10K$ | $10K \leq F < 100K$ | $100K \leq F$ |
| $4.7 < C \leq 33$ | 0.05 | 0.32 | 0.67 | 1.00 |
| $33 < C$ | 0.10 | 0.35 | 0.70 | 1.00 |

Dimensions

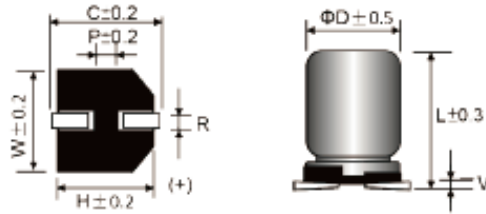

(UNIT: mm)

| Size | ψD | L | W | H | C | R | P | V max |
|---------|------|------|------|------|------|---------|-----|-------|
| 6.3x6.0 | 6.3 | 6.0 | 6.6 | 6.6 | 7.3 | 0.5~0.8 | 2.1 | 0.3 |
| 6.3x7.7 | 6.3 | 7.7 | 6.6 | 6.6 | 7.3 | 0.5~0.8 | 2.1 | 0.3 |
| 8x10.5 | 8.0 | 10.5 | 8.3 | 8.3 | 9.0 | 0.7~1.1 | 3.2 | 0.3 |
| 10x10.5 | 10.0 | 10.5 | 10.3 | 10.3 | 11.0 | 0.7~1.3 | 4.5 | 0.3 |
| 10x12.5 | 10.0 | 12.5 | 10.3 | 10.3 | 11.0 | 0.7~1.3 | 4.5 | 0.3 |

HSA SERIES STANDARD CHARACTERISTICS LIST

| Rated Voltage (S.V.) | Cap (μF) | Size DxL | Leakage current (μA) max. | ESR (mΩ) max. 100k to 300 KHz / 20°C | Rated Ripple Current (mA rms) 100 KHz / 105°C | D.F. (tanδ) max. 120 Hz / 20°C |
|----------------------|----------|-----------|---------------------------|--------------------------------------|---|--------------------------------|
| 16 (18.4) | 82 | 6.3 x 6.0 | 13 | 55 | 1,380 | 0.16 |
| | 120 | 6.3x7.7 | 19 | 40 | 1,500 | 0.16 |
| | 270 | 8x10.5 | 43 | 26 | 2,000 | 0.16 |
| | 470 | 10x10.5 | 75 | 21 | 2,600 | 0.16 |
| | 560 | 10x12.5 | 90 | 15 | 3,000 | 0.16 |
| 25 (28.8) | 47 | 6.3 x 6.0 | 12 | 60 | 1,270 | 0.16 |
| | 68 | 6.3x7.7 | 17 | 45 | 1,400 | 0.16 |
| | 150 | 8x10.5 | 38 | 27 | 1,900 | 0.16 |
| | 270 | 10x10.5 | 68 | 22 | 2,500 | 0.16 |
| | 330 | 10x12.5 | 83 | 16 | 2,900 | 0.16 |
| 35 (40.3) | 27 | 6.3 x 6.0 | 9 | 100 | 1,080 | 0.16 |
| | 47 | 6.3x7.7 | 16 | 60 | 1,300 | 0.16 |
| | 100 | 8x10.5 | 35 | 30 | 1,800 | 0.16 |
| | 150 | 10x10.5 | 53 | 23 | 2,400 | 0.16 |
| | 220 | 10x12.5 | 77 | 17 | 2,800 | 0.16 |
| 40 (46) | 18 | 6.3 x 6.0 | 7 | 110 | 1,030 | 0.16 |
| | 27 | 6.3x7.7 | 11 | 70 | 1,200 | 0.16 |
| | 56 | 8x10.5 | 22 | 32 | 1,700 | 0.16 |
| | 100 | 10x10.5 | 40 | 24 | 2,400 | 0.16 |
| | 120 | 10x12.5 | 48 | 18 | 2,700 | 0.16 |
| 50 (57.5) | 10 | 6.3 x 6.0 | 5 | 120 | 980 | 0.16 |
| | 15 | 6.3x7.7 | 8 | 80 | 1,200 | 0.16 |
| | 33 | 8x10.5 | 17 | 35 | 1,600 | 0.16 |
| | 56 | 10x10.5 | 28 | 25 | 2,300 | 0.16 |
| | 82 | 10x12.5 | 41 | 19 | 2,600 | 0.16 |

HSA SERIES STANDARD CHARACTERISTICS LIST

| Rated Voltage (S.V.) | Cap (μF) | Size DxL | Leakage current (μA) max. | ESR (mΩ) max. 100k to 300 KHz / 20°C | Rated Ripple Current (mA rms) 100 KHz / 105°C | D.F. (tanδ) max. 120 Hz / 20°C |
|-----------------------|----------|-----------|---------------------------|--------------------------------------|---|--------------------------------|
| 63 (72.5) | 6.8 | 6.3 x 6.0 | 4 | 150 | 960 | 0.16 |
| | 10 | 6.3x7.7 | 6 | 100 | 1,000 | 0.16 |
| | 22 | 8x10.5 | 14 | 40 | 1,500 | 0.16 |
| | 33 | 8x10.5 | 21 | 40 | 1,500 | 0.16 |
| | | 10x10.5 | 21 | 30 | 2,100 | 0.16 |
| | 47 | 10x10.5 | 30 | 30 | 2,100 | 0.16 |
| 80 (92) | 56 | 10x12.5 | 35 | 22 | 2,400 | 0.16 |
| | 12 | 10x10.5 | 10 | 70 | 1,600 | 0.16 |
| | 15 | 10x10.5 | 12 | 70 | 1,600 | 0.16 |
| 100 (115) | 18 | 10x12.5 | 14 | 50 | 1,800 | 0.16 |
| | 10 | 10x10.5 | 10 | 80 | 1,400 | 0.16 |
| | 12 | 10x10.5 | 12 | 80 | 1,400 | 0.16 |
| 125 (143.8) | 15 | 10x12.5 | 15 | 60 | 1,600 | 0.16 |
| | 10 | 10x10.5 | 13 | 90 | 1,200 | 0.16 |

Conductive Polymer Hybrid Aluminum Electrolytic Capacitors

HSB Series

- Low ESR.
- High Voltage, Long Life.
- 125°C, 2,000~4,000hrs.
- RoHS Compliant
- For automotive modules and other high temperature applications

Specifications

| Items | Conditions | Characteristics |
|----------------------------|--|---|
| Category Temperature Range | - | -55 to +125°C |
| Rated Voltage Range | - | 16 ~ 125V |
| Capacitance Tolerance | at 20°C, 120 Hz | ±20% (M) |
| Surge Voltage | at 15 ~ 35°C | Rated voltage x 1.15V |
| Leakage Current | at 20°C after 2 minutes | $I \leq 0.01CV$ or $3(\mu A)$ Whichever is greater measured, after 2 minutes application of rated working voltage at +20°C. Please see the attached characteristics list |
| Dissipation Factor (tan δ) | at 20°C, 120 Hz | Please see the attached characteristics list |
| Endurance | The following specifications shall be satisfied when the capacitors are restored to 20°C after the rated voltage is applied for 2,000 to 4,000 hours at 125°C. Φ 6.3=2,000hrs, D ≥ Φ 8=4,000hrs. | Appearance NO significant damage. |
| | | Capacitance change $\leq \pm 30\%$ of the initial value. |
| | | DF (tan δ) $\leq 200\%$ of the initial specified value. |
| | | ESR $\leq 200\%$ of the initial specified value. |
| | | Leakage current \leq The initial specified value. |
| Damp Heag (Steady State) | The following specifications shall be satisfied when the capacitors are restored to 20°C after subjecting them to store at 60°C, 90 to 95% RH for 1,000 hours, without DC applied. | Appearance NO significant damage. |
| | | Capacitance change $\leq \pm 30\%$ of the initial value. |
| | | DF (tan δ) $\leq 200\%$ of the initial specified value. |
| | | ESR $\leq 200\%$ of the initial specified value. |
| | | Leakage current \leq The initial specified value. |
| Surge Voltage | The capacitors shall be subjected to 1,000 cycles each consisting of charge with the surge voltages specified at 15~35°C for 30 seconds through a protective resistor (R = 1 kΩ) and discharge for 5 minutes 30 seconds. | Appearance NO significant damage. |
| | | Capacitance change $\leq \pm 30\%$ of the initial value. |
| | | DF (tan δ) $\leq 200\%$ of the initial specified value. |
| | | ESR $\leq 200\%$ of the initial specified value. |
| | | Leakage current \leq The initial specified value. |

※ Note : If any doubt arises, measure the leakage current after following voltage treatment.
Voltage treatment : DC rated voltage are applied to the capacitors for 120 minutes at 125°C.

Frequency Coefficient for Ripple Current

| Capacitance (μF) | Frequency (Hz) | | | |
|-------------------|-------------------|-------------------|---------------------|---------------|
| | $100 \leq F < 1K$ | $1K \leq F < 10K$ | $10K \leq F < 100K$ | $100K \leq F$ |
| $4.7 < C \leq 33$ | 0.05 | 0.32 | 0.67 | 1.00 |
| $33 < C$ | 0.10 | 0.35 | 0.70 | 1.00 |

Dimensions

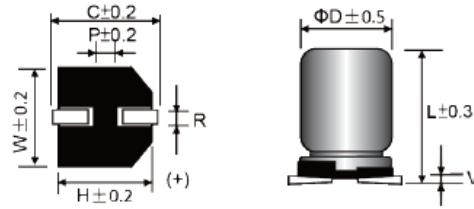

(Unit: mm)

| Size | φ D | L | w | H | C | R | P | Vmax |
|---------|------|------|------|------|------|---------|-----|------|
| 6.3x6.0 | 6.3 | 6.0 | 6.6 | 6.6 | 7.3 | 0.5-0.8 | 2.1 | 0.3 |
| 6.3x7.7 | 6.3 | 7.7 | 6.6 | 6.6 | 7.3 | 0.5-0.8 | 2.1 | 0.3 |
| 8x10.5 | 8.0 | 10.5 | 8.3 | 8.3 | 9.0 | 0.7-1.1 | 3.2 | 0.3 |
| 10x10.5 | 10.0 | 10.5 | 10.3 | 10.3 | 11.0 | 0.7-1.3 | 4.5 | 0.3 |
| 10x12.5 | 10.0 | 12.5 | 10.3 | 10.3 | 11.0 | 0.7-1.3 | 4.5 | 0.3 |

HSB SERIES STANDARD CHARACTERISTICS LIST

| Rated Voltage (S.V) | Cap (μF) | Size Code DxL | Leakage Current (μA) max. | ESR (mΩ) max. 100k to 300kHz/20°C | Rated Ripple Current(mA rms) 100kHz / 125° C | D.F. (tanδ) max. 120Hz/20°C |
|---------------------|----------|---------------|---------------------------|-----------------------------------|--|-----------------------------|
| 16 (18.8) | 82 | 6.3x6.0 | 13 | 55 | 970 | 0.16 |
| | 120 | 6.3x7.7 | 19 | 40 | 1,100 | 0.16 |
| | 270 | 8x10.5 | 43 | 26 | 1,500 | 0.16 |
| | 470 | 10x10.5 | 75 | 21 | 2,000 | 0.16 |
| | 560 | 10x12.5 | 90 | 15 | 2,300 | 0.16 |
| 25 (28.8) | 47 | 6.3x6.0 | 12 | 60 | 890 | 0.16 |
| | 68 | 6.3x7.7 | 17 | 45 | 1,100 | 0.16 |
| | 150 | 8x10.5 | 38 | 27 | 1,300 | 0.16 |
| | 270 | 10x10.5 | 68 | 22 | 1,500 | 0.16 |
| | 330 | 10x12.5 | 83 | 16 | 1,700 | 0.16 |
| 35 (40.3) | 27 | 6.3x6.0 | 9 | 100 | 760 | 0.16 |
| | 47 | 6.3x7.7 | 16 | 60 | 900 | 0.16 |
| | 100 | 8x10.5 | 35 | 30 | 1,200 | 0.16 |
| | 150 | 10x10.5 | 53 | 23 | 1,400 | 0.16 |
| | 220 | 10x12.5 | 77 | 17 | 1,700 | 0.16 |
| 40 (46.0) | 18 | 6.3x6.0 | 7 | 110 | 720 | 0.16 |
| | 27 | 6.3x7.7 | 11 | 70 | 900 | 0.16 |
| | 56 | 8x10.5 | 22 | 32 | 1,200 | 0.16 |
| | 100 | 10x10.5 | 40 | 24 | 1,400 | 0.16 |
| | 120 | 10x12.5 | 48 | 18 | 1,600 | 0.16 |
| 50 (57.5) | 10 | 6.3x6.0 | 5 | 120 | 690 | 0.16 |
| | 15 | 6.3x7.7 | 8 | 80 | 800 | 0.16 |
| | 33 | 8x10.5 | 17 | 35 | 1,100 | 0.16 |
| | 56 | 10x10.5 | 28 | 25 | 1,300 | 0.16 |
| | 82 | 10x12.5 | 41 | 19 | 1,500 | 0.16 |

HSB SERIES STANDARD CHARACTERISTICS LIST

| Rated Voltage (S.V) | Cap (μF) | Size Code DxL | Leakage Current (μA) max. | ESR (mΩ) max. 100k to 300kHz/20°C | Rated Ripple Current(mA rms) 100kHz / 125° C | D.F. (tanδ) max. 120Hz/20°C |
|------------------------|----------|---------------|---------------------------|-----------------------------------|--|-----------------------------|
| 63 (72.5) | 6.8 | 6.3x6.0 | 4 | 150 | 670 | 0.16 |
| | 10 | 6.3x7.7 | 6 | 100 | 700 | 0.16 |
| | 22 | 8x10.5 | 14 | 40 | 1,000 | 0.16 |
| | 33 | 8x10.5 | 21 | 40 | 1,000 | 0.16 |
| | | 10x10.5 | 21 | 30 | 1,200 | 0.16 |
| | 47 | 10x10.5 | 30 | 30 | 1,200 | 0.16 |
| 80 (92.0) | 56 | 10x12.5 | 35 | 22 | 1,400 | 0.16 |
| | 12 | 10x10.5 | 10 | 70 | 900 | 0.16 |
| | 15 | 10x10.5 | 12 | 70 | 900 | 0.16 |
| 100 (115) | 18 | 10x12.5 | 14 | 50 | 1,100 | 0.16 |
| | 10 | 10x10.5 | 10 | 80 | 800 | 0.16 |
| | 12 | 10x10.5 | 12 | 80 | 800 | 0.16 |
| 125 (143.8) | 15 | 10x12.5 | 15 | 60 | 1,000 | 0.16 |
| | 10 | 10x10.5 | 13 | 90 | 700 | 0.16 |

Conductive Polymer Hybrid Aluminum Electrolytic Capacitors HSC Series

- Low ESR, Anti-vibration, Peak acceleration:30G
- High Voltage, Long Life.
- 105°C, 10,000hrs.
- RoHS compliant
- For high reliability applications. (Automotive equipment, Base station equipment, etc.)

| Items | Conditions | Characteristics | |
|----------------------------|--|---|---------------------------------------|
| Category Temperature Range | — | -55 to +105°C | |
| Rated Voltage Range | — | 16 ~ 125V | |
| Capacitance Tolerance | at 20°C,120Hz | ±20%(M) | |
| Surge Voltage | at 15 ~ 35°C | Rated voltage ×1.15V | |
| Leakage Current | at 20°C after 2 minutes | $I \leq 0.01CV$ or $3(\mu A)$ Whichever is greater measured, after 2 minutes application of rated working voltage at +20°C. Please see the attached characteristics list | |
| Dissipation Factor (tanδ) | at 20°C,120Hz | Please see the attached characteristics list | |
| Endurance | The following specifications shall be satisfied when the capacitors are restored to 20°C after the rated voltage is applied for 10,000 hours at 105°C. | Appearance | NO significant damage. |
| | | Capacitance change | $\leq \pm 30\%$ of the initial value. |
| | | DF (tan δ) | $\leq 200\%$ of the initial specified |
| | | ESR | $\leq 200\%$ of the initial specified |
| | | Leakage | \leq The initial specified value. |
| Damp Heag (SteadyState) | The following specifications shall be satisfied when the capacitors are restored to 20°C after subjecting them to subjecting them to store at 60°C, 90 to 95% RH for 1,000 hours, without DC applied. | Appearance | NO significant damage. |
| | | Capacitance change | $\leq \pm 30\%$ of the initial value. |
| | | DF (tan δ) | $\leq 200\%$ of the initial specified |
| | | ESR | $\leq 200\%$ of the initial specified |
| | | Leakage | \leq The initial specified value. |
| Surge Voltage | The capacitors shall be subjected to 1,000 cycles each consisting of charge with the surge voltages specified at 15~35°C for 30 seconds through a protective resistor (R = 1 kΩ) and discharge for 5 minutes 30 seconds. | Appearance | NO significant damage. |
| | | Capacitance change | $\leq \pm 30\%$ of the initial value. |
| | | DF (tan δ) | $\leq 200\%$ of the initial specified |
| | | ESR | $\leq 200\%$ of the initial specified |
| | | Leakage | \leq The initial specified value. |

※ Note : If any doubt arises, measure the leakage current after following voltage treatment.
Voltage treatment : DC rated voltage are applied to the capacitors for 120 minutes at 105°C.

Frequency Coefficient of Permissible Ripple Current

| Capacitance (μF) | Frequency (Hz) | | | |
|-------------------|-------------------|-------------------|---------------------|---------------|
| | $100 \leq F < 1K$ | $1K \leq F < 10K$ | $10K \leq F < 100K$ | $100K \leq F$ |
| $4.7 < C \leq 33$ | 0.05 | 0.32 | 0.67 | 1.00 |
| $33 < C$ | 0.10 | 0.35 | 0.70 | 1.00 |

**Conductive Polymer Hybrid Aluminum Electrolytic Capacitors
Dimensions**

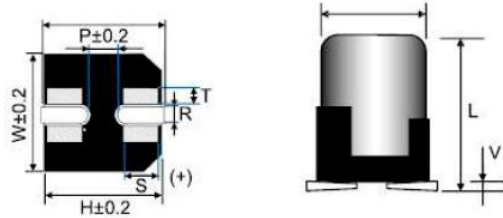

(Unit: mm)

| Size | D ±0.5 | L ±0.5 | W ±0.2 | H ±0.2 | C ±0.2 | R | p ±0.2 | V _{max} |
|---------|--------|--------|--------|--------|--------|---------|--------|------------------|
| 6.3×6.0 | 6.3 | 6.0 | 6.6 | 6.6 | 7.3 | 0.5~0.8 | 2.1 | 0.3 |
| 6.3×8.0 | 6.3 | 8.0 | 6.6 | 6.6 | 7.3 | 0.5~0.8 | 2.1 | 0.3 |
| 8×10.5 | 8.0 | 10.5 | 8.3 | 8.3 | 9.0 | 1.0~1.4 | 3.2 | 0.3 |
| 10×10.5 | 10.0 | 10.5 | 10.3 | 10.3 | 11.0 | 1.0~1.4 | 4.5 | 0.3 |
| 10×12.5 | 10.0 | 12.5 | 10.3 | 10.3 | 11.0 | 1.0~1.4 | 4.5 | 0.3 |

HSC SERIES STANDARD CHARACTERISTICS LIST

| Rated Voltage (S.V) | Cap (μF) | Size Code D×L | Leakage Current (μA) max. | ESR (mΩ) max. 100k to 300kHz/20°C | Rated Ripple Current (mA rms) 100kHz / 105° C | D.F (tanδ) max. 120Hz/20°C |
|---------------------|----------|---------------|---------------------------|-----------------------------------|---|----------------------------|
| 16 (18.4) | 82 | 6.3 x6.0 | 13 | 55 | 1,380 | 0.16 |
| | 120 | 6.3x8.0 | 19 | 40 | 1,500 | 0.16 |
| | 270 | 8x10.5 | 43 | 26 | 2,000 | 0.16 |
| | 470 | 10x10.5 | 75 | 21 | 2,600 | 0.16 |
| | 560 | 10x12.5 | 90 | 15 | 3,000 | 0.16 |
| 25 (28.8) | 47 | 6.3x6.0 | 12 | 60 | 1,270 | 0.16 |
| | 68 | 6.3x8.0 | 17 | 45 | 1,400 | 0.16 |
| | 150 | 8x10.5 | 38 | 27 | 1,900 | 0.16 |
| | 270 | 10x10.5 | 68 | 22 | 2,500 | 0.16 |
| | 330 | 10x12.5 | 83 | 16 | 2,900 | 0.16 |
| 35 (40.3) | 27 | 6.3x6.0 | 9 | 100 | 1,080 | 0.16 |
| | 47 | 6.3x8.0 | 16 | 60 | 1,300 | 0.16 |
| | 100 | 8x10.5 | 35 | 30 | 1,800 | 0.16 |
| | 150 | 10x10.5 | 53 | 23 | 2,400 | 0.16 |
| | 220 | 10x12.5 | 77 | 17 | 2,800 | 0.16 |
| 40 (46.0) | 18 | 6.3x6.0 | 7 | 110 | 1,030 | 0.16 |
| | 27 | 6.3x8.0 | 11 | 70 | 1,200 | 0.16 |
| | 56 | 8x10.5 | 22 | 32 | 1,700 | 0.16 |
| | 100 | 10x10.5 | 40 | 24 | 2,400 | 0.16 |
| | 120 | 10x12.5 | 48 | 18 | 2,700 | 0.16 |
| 50 (57.5) | 10 | 6.3x6.0 | 5 | 120 | 980 | 0.16 |
| | 15 | 6.3x8.0 | 8 | 80 | 1,200 | 0.16 |
| | 33 | 8x10.5 | 17 | 35 | 1,600 | 0.16 |
| | 56 | 10x10.5 | 28 | 25 | 2,300 | 0.16 |
| | 82 | 10x12.5 | 41 | 19 | 2,600 | 0.16 |

HSC SERIES STANDARD CHARACTERISTICS LIST

| Rated Voltage (S.V) | Cap (μF) | Size Code DxL | Leakage Current (μA) max. | ESR (mΩ) max. 100k to 300kHz/20°C | Rated Ripple Current (mA rms) 100kHz / 105° C | D.F (tanδ) max. 120Hz/20°C |
|---------------------|----------|---------------|---------------------------|-----------------------------------|---|----------------------------|
| 63 (72.5) | 6.8 | 6.3x6.0 | 4 | 150 | 960 | 0.16 |
| | 10 | 6.3x8.0 | 6 | 100 | 1,000 | 0.16 |
| | 22 | 8x10.5 | 14 | 40 | 1,500 | 0.16 |
| | 33 | 8x10.5 | 21 | 40 | 1,500 | 0.16 |
| | | 10x10.5 | 21 | 30 | 2,100 | 0.16 |
| | 47 | 10x10.5 | 30 | 30 | 2,100 | 0.16 |
| 56 | 10x12.5 | 35 | 22 | 2,400 | 0.16 | |
| 80 (92.0) | 12 | 10x10.5 | 10 | 70 | 1,600 | 0.16 |
| | 15 | 10x10.5 | 12 | 70 | 1,600 | 0.16 |
| | 18 | 10x12.5 | 14 | 50 | 1,800 | 0.16 |
| 100 (115.0) | 10 | 10x10.5 | 10 | 80 | 1,400 | 0.16 |
| | 12 | 10x10.5 | 12 | 80 | 1,400 | 0.16 |
| | 15 | 10x12.5 | 15 | 60 | 1,600 | 0.16 |
| 125 (143.8) | 10 | 10x10.5 | 13 | 90 | 1,200 | 0.16 |

Conductive Polymer Hybrid Aluminum Electrolytic Capacitors

HSD Series

- Low ESR, Anti-vibration, Peak acceleration:30G
- High Voltage, Long Life.
- 125°C, 4,000hrs.
- RoHS compliant
- For automotive modules and other high temperature applications

| Item | Conditions | Characteristics | |
|----------------------------|--|---|---|
| Category Temperature Range | — | -55 to +125°C | |
| Rated Voltage Range | — | 16 ~ 125V | |
| Capacitance Tolerance | at 20°C,120Hz | ±20%(M) | |
| Surge Voltage | at 15 ~ 35°C | Rated voltage ×1.15V | |
| Leakage Current | at 20°C after 2 minutes | $I \leq 0.01CV$ or $3(\mu A)$ Whichever is greater measured, after 2 minutes application of rated working voltage at +20°C. Please see the attached characteristics list | |
| Dissipation Factor (tanδ) | at 20°C,120Hz | Please see the attached characteristics list | |
| Endurance | The following specifications shall be satisfied when the capacitors are restored to 20°C after the rated voltage is applied for 4,000 hours at 125°C. | Appearance | NO significant damage. |
| | | Capacitance change | $\leq \pm 30\%$ of the initial value. |
| | | DF (tan δ) | $\leq 200\%$ of the initial specified value |
| | | ESR | $\leq 200\%$ of the initial specified value |
| | | Leakage Current | \leq The initial specified value. |
| Damp Heag (SteadyState) | The following specifications shall be satisfied when the capacitors are restored to 20°C after subjecting them to subjecting them to store at 60°C, 90 to 95% RH for 1,000 hours, without DC applied. | Appearance | NO significant damage. |
| | | Capacitance change | $\leq \pm 30\%$ of the initial value. |
| | | DF (tan δ) | $\leq 200\%$ of the initial specified value |
| | | ESR | $\leq 200\%$ of the initial specified value |
| | | Leakage Current | \leq The initial specified value. |
| Surge Voltage | The capacitors shall be subjected to 1,000 cycles each consisting of charge with the surge voltages specified at 15~35°C for 30 seconds through a protective resistor (R = 1 kΩ) and discharge for 5 minutes 30 seconds. | Appearance | NO significant damage. |
| | | Capacitance change | $\leq \pm 30\%$ of the initial value. |
| | | DF (tan δ) | $\leq 200\%$ of the initial specified value |
| | | ESR | $\leq 200\%$ of the initial specified value |
| | | Leakage Current | \leq The initial specified value. |

※ Note: If any doubt arises, measure the leakage current after following voltage treatment.
Voltage treatment: DC rated voltage are applied to the capacitors for 120 minutes at 125°C.

Frequency Coefficient of Permissible Ripple Current

| Capacitance (μF) | Frequency(Hz) | | | |
|-------------------|-------------------|-------------------|---------------------|---------------|
| | $100 \leq F < 1K$ | $1K \leq F < 10K$ | $10K \leq F < 100K$ | $100K \leq F$ |
| $4.7 < C \leq 33$ | 0.05 | 0.32 | 0.67 | 1.00 |
| $33 < C$ | 0.10 | 0.35 | 0.70 | 1.00 |

Conductive Polymer Hybrid Aluminum Electrolytic Capacitors

Dimensions

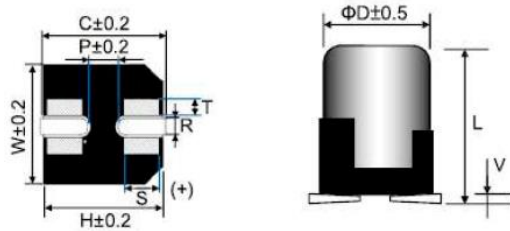

(Unit: mm)

| Size | D ^{±0.5} | L ^{±0.5} | W ^{±0.2} | H ^{±0.2} | C ^{±0.2} | R | P ^{±0.2} | V ^{max} |
|---------|-------------------|-------------------|-------------------|-------------------|-------------------|---------|-------------------|------------------|
| 6.3x6.0 | 6.3 | 6.0 | 6.6 | 6.6 | 7.3 | 0.5~0.8 | 2.1 | 0.3 |
| 6.3x8.0 | 6.3 | 8.0 | 6.6 | 6.6 | 7.3 | 0.5~0.8 | 2.1 | 0.3 |
| 8x10.5 | 8.0 | 10.5 | 8.3 | 8.3 | 9.0 | 1.0~1.4 | 3.2 | 0.3 |
| 10x10.5 | 10.0 | 10.5 | 10.3 | 10.3 | 11.0 | 1.0~1.4 | 4.5 | 0.3 |
| 10x12.5 | 10.0 | 12.5 | 10.3 | 10.3 | 11.0 | 1.0~1.4 | 4.5 | 0.3 |

HSD SERIES STANDARD CHARACTERISTICS LIST

| Rated Voltage (S.V) | Cap (μF) | Size Code DxL | Leakage Current (μA) max. | ESR (mΩ) max.100k to 300kHz / 20°C | Rated Ripple Current (mA rms) 100kHz / 125°C | D.F (tanδ) max. 120Hz / 20°C |
|---------------------|----------|---------------|---------------------------|------------------------------------|--|------------------------------|
| 16 (18.4) | 82 | 6.3x6.0 | 13 | 55 | 970 | 0.16 |
| | 120 | 6.3x8.0 | 19 | 40 | 1,100 | 0.16 |
| | 270 | 8x10.5 | 43 | 26 | 1,500 | 0.16 |
| | 470 | 10x10.5 | 75 | 21 | 2,000 | 0.16 |
| | 560 | 10x12.5 | 90 | 15 | 2,300 | 0.16 |
| 25 (28.8) | 47 | 6.3x6.0 | 12 | 60 | 890 | 0.16 |
| | 68 | 6.3x8.0 | 17 | 45 | 1,100 | 0.16 |
| | 150 | 8x10.5 | 38 | 27 | 1,300 | 0.16 |
| | 270 | 10x10.5 | 68 | 22 | 1,500 | 0.16 |
| | 330 | 10x12.5 | 83 | 16 | 1,700 | 0.16 |
| 35 (40.3) | 27 | 6.3x6.0 | 9 | 100 | 760 | 0.16 |
| | 47 | 6.3x8.0 | 16 | 60 | 900 | 0.16 |
| | 100 | 8x10.5 | 35 | 30 | 1,200 | 0.16 |
| | 150 | 10x10.5 | 53 | 23 | 1,400 | 0.16 |
| | 220 | 10x12.5 | 77 | 17 | 1,700 | 0.16 |
| 40 (46.0) | 18 | 6.3x6.0 | 7 | 110 | 720 | 0.16 |
| | 27 | 6.3x8.0 | 11 | 70 | 900 | 0.16 |
| | 56 | 8x10.5 | 22 | 32 | 1,200 | 0.16 |
| | 100 | 10x10.5 | 40 | 24 | 1,400 | 0.16 |
| | 120 | 10x12.5 | 48 | 18 | 1,600 | 0.16 |
| 50 (57.5) | 10 | 6.3x6.0 | 5 | 120 | 690 | 0.16 |
| | 15 | 6.3x8.0 | 8 | 80 | 800 | 0.16 |
| | 33 | 8x10.5 | 17 | 35 | 1,100 | 0.16 |
| | 56 | 10x10.5 | 28 | 25 | 1,300 | 0.16 |

HSD SERIES STANDARD CHARACTERISTICS LIST

| Rated Voltage (S.V) | Cap (μF) | Size Code DxL | Leakage Current (μA) max. | ESR (mΩ) max.100k to 300kHz / 20°C | Rated Ripple Current (mA rms) 100kHz / 125°C | D.F (tanδ) max. 120Hz /20°C |
|------------------------|----------|---------------|---------------------------|------------------------------------|--|-----------------------------|
| 63 (72.5) | 82 | 10x12.5 | 41 | 19 | 1,500 | 0.16 |
| | 6.8 | 6.3x6.0 | 4 | 150 | 670 | 0.16 |
| | 10 | 6.3x8.0 | 6 | 100 | 700 | 0.16 |
| | 22 | 8x10.5 | 14 | 40 | 1,000 | 0.16 |
| | 33 | 8x10.5 | 21 | 40 | 1,000 | 0.16 |
| | | 10x10.5 | 21 | 40 | 1,200 | 0.16 |
| | 47 | 10x10.5 | 30 | 30 | 1,200 | 0.16 |
| | 56 | 10x12.5 | 35 | 22 | 1,400 | 0.16 |
| 80 (92.0) | 12 | 10x10.5 | 10 | 70 | 900 | 0.16 |
| | 15 | 10x10.5 | 12 | 70 | 900 | 0.16 |
| | 18 | 10x12.5 | 14 | 50 | 1,100 | 0.16 |
| 100 (115.0) | 10 | 10x10.5 | 10 | 80 | 800 | 0.16 |
| | 12 | 10x10.5 | 12 | 80 | 800 | 0.16 |
| | 15 | 10x12.5 | 15 | 60 | 1,000 | 0.16 |
| 125 (143.8) | 10 | 10x10.5 | 13 | 90 | 700 | 0.16 |

Conductive Polymer Hybrid Aluminum Electrolytic Capacitors

HSE Series

- Low ESR. High Temperature
- High Voltage, Long Life.
- 135°C, 1,000 to 2,000hrs.
- RoHS compliant
- For automotive modules and other high temperature applications

| Items | Conditions | Characteristics | |
|-----------------------------------|--|---|--|
| Category Temperature Range | — | -55 to +135°C | |
| Rated Voltage Range | — | 25 ~ 63V | |
| Capacitance Tolerance | at 20°C,120Hz | ±20%(M) | |
| Surge Voltage | at 15 ~ 35°C | Rated voltage ×1.15V | |
| Leakage Current | at 20°C after 2 minutes | I ≤ 0.01CV or 3(μA) Whichever is greater measured, after 2 minutes application of rated working voltage at +20°C. Please see the attached characteristics list | |
| Dissipation Factor (tan δ) | at 20°C,120Hz | Please see the attached characteristics list | |
| Endurance | The following specifications shall be satisfied when the capacitors are restored to 20°C after the rated voltage is applied for 1,000 to 2,000 hours at 135°C. Φ6.3=1,000hrs, D≥Φ8=2,000hrs. | Appearance | NO significant damage. |
| | | Capacitance change | ≤ ±30% of the initial value. |
| | | DF (tan δ) | ≤ 200% of the initial specified value. |
| | | ESR | ≤ 200% of the initial specified value. |
| | | Leakage Current | ≤ The initial specified value. |
| Damp Heag (Steady State) | The following specifications shall be satisfied when the capacitors are restored to 20°C after subjecting them to subjecting them to store at 60°C, 90 to 95% RH for 1,000 hours, without DC applied. | Appearance | NO significant damage. |
| | | Capacitance change | ≤ ±30% of the initial value. |
| | | DF (tan δ) | ≤ 200% of the initial specified value. |
| | | ESR | ≤ 200% of the initial specified value. |
| | | Leakage Current | ≤ The initial specified value. |
| Surge Voltage | The capacitors shall be subjected to 1,000 cycles each consisting of charge with the surge voltages specified at 15~35°C for 30 seconds through a protective resistor (R = 1 kΩ) and discharge for 5 minutes 30 seconds. | Appearance | NO significant damage. |
| | | Capacitance change | ≤ ±30% of the initial value. |
| | | DF (tan δ) | ≤ 200% of the initial specified value. |
| | | ESR | ≤ 200% of the initial specified value. |
| | | Leakage | ≤ The initial specified value. |

※ Note: If any doubt arises, measure the leakage current after following voltage treatment.
Voltage treatment: DC rated voltage are applied to the capacitors for 120 minutes at 135°C.

Frequency Coefficient of Permissible Ripple Current

| Capacitance (μF) | Frequency(Hz) | | | |
|------------------|---------------|--------------|----------------|----------|
| | 100 ≤ F < 1K | 1K ≤ F < 10K | 10K ≤ F < 100K | 100K ≤ F |
| 4.7 < C ≤ 33 | 0.05 | 0.32 | 0.67 | 1.00 |
| 33 < C | 0.10 | 0.35 | 0.70 | 1.00 |

Dimensions

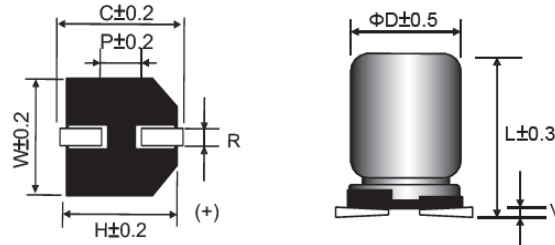

(UNIT: mm)

| Size | ØD | L | W | H | C | R | P | V max |
|---------|------|------|------|------|------|---------|-----|-------|
| 6.3×7.7 | 6.3 | 7.7 | 6.6 | 6.6 | 7.3 | 0.5~0.8 | 2.1 | 0.3 |
| 8×10.5 | 8.0 | 10.5 | 8.3 | 8.3 | 9.0 | 0.7~1.1 | 3.2 | 0.3 |
| 10×10.5 | 10.0 | 10.5 | 10.3 | 10.3 | 11.0 | 0.7~1.3 | 4.5 | 0.3 |
| 10×12.5 | 10.0 | 12.5 | 10.3 | 10.3 | 11.0 | 0.7~1.3 | 4.5 | 0.3 |

HSE SERIES STANDARD CHARACTERISTICS LIST

| Rated voltage (S.V.) | Cap (µF) | Size Code DxL | Leakage current (µA) max. | ESR (mΩ) max. 100k to 300kHz / 20°C | Rated Ripple Current (mA rms) 100kHz / 135°C | D.F. (tanδ) max. 120Hz / 20°C |
|----------------------|----------|---------------|---------------------------|-------------------------------------|--|-------------------------------|
| 25 (28.8) | 68 | 6.3×7.7 | 17 | 45 | 750 | 0.16 |
| | 150 | 8×10.5 | 38 | 27 | 1,000 | 0.16 |
| | 270 | 10×10.5 | 68 | 22 | 1,200 | 0.16 |
| | 330 | 10×12.5 | 83 | 16 | 1,350 | 0.16 |
| 35 (40.3) | 47 | 6.3×7.7 | 16 | 60 | 730 | 0.16 |
| | 100 | 8×10.5 | 35 | 30 | 1,000 | 0.16 |
| | 150 | 10×10.5 | 53 | 23 | 1,100 | 0.16 |
| | 220 | 10×12.5 | 77 | 17 | 1,300 | 0.16 |
| 40 (46) | 27 | 6.3×7.7 | 11 | 70 | 700 | 0.16 |
| | 56 | 8×10.5 | 22 | 32 | 950 | 0.16 |
| | 100 | 10×10.5 | 40 | 24 | 1,100 | 0.16 |
| | 120 | 10×12.5 | 48 | 18 | 1,300 | 0.16 |
| 50 (57.5) | 15 | 6.3×7.7 | 8 | 80 | 650 | 0.16 |
| | 33 | 8×10.5 | 17 | 35 | 900 | 0.16 |
| | 56 | 10×10.5 | 28 | 25 | 1,100 | 0.16 |
| | 82 | 10×12.5 | 41 | 19 | 1,250 | 0.16 |
| 63 (72.5) | 10 | 6.3×7.7 | 6 | 100 | 550 | 0.16 |
| | 22 | 8×10.5 | 14 | 40 | 850 | 0.16 |
| | 33 | 8×10.5 | 21 | 40 | 850 | 0.16 |
| | | 10×10.5 | 21 | 30 | 1,000 | 0.16 |
| | 47 | 10×10.5 | 30 | 30 | 1,000 | 0.16 |
| 56 | 10×12.5 | 35 | 22 | 1,100 | 0.16 | |

PRA Series

- Standard radial lead type
- Rated voltage: 2.5~25V
- Endurance: 2,000 hours at 105°C
- Applications: motherboards, servers, VGA, etc
- RoHS Compliant
- Halogen Free compliant

Specifications

| Items | Conditions | Characteristics |
|---|--|--|
| Category Temperature Range | - | -55 to +105°C |
| Rated Voltage Range | - | 2.5 ~ 25V |
| Capacitance Tolerance | at 20°C, 120 Hz | ±20% (M) |
| Surge Voltage | at 105°C | Rated voltage x 1.15V |
| Leakage Current | at 20°C after 2 minutes | $I \leq 0.2CV$ or $300(\mu A)$ Whichever is greater measured, after 2 minutes application of rated working voltage at +20°C. Please see the attached characteristics list |
| Dissipation Factor (tan δ) | at 20°C, 120 Hz | Please see the attached characteristics list |
| Characteristics of Impedance at low, high temperature | at -55°C, 100 KHz | $Z(-55^\circ C) / Z(+20^\circ C) \leq 1.25$ |
| | at -25°C, 100 KHz | $Z(-25^\circ C) / Z(+20^\circ C) \leq 1.15$ |
| Endurance | The following specifications shall be satisfied when the capacitors are restored to 20°C after the rated voltage is applied for 2,000 hours at 105°C. | Appearance NO significant damage. |
| | | Capacitance change $\leq \pm 20\%$ of the initial value. |
| | | DF (tan δ) $\leq 150\%$ of the initial specified value. |
| | | ESR $\leq 150\%$ of the initial specified value. |
| | | Leakage current \leq The initial specified value. |
| Damp Heag (Steady State) | The following specifications shall be satisfied when the capacitors are restored to 20°C after subjecting them to store 60°C, 90 to 95% RH for 1,000 hours, without DC applied. | Appearance NO significant damage. |
| | | Capacitance change $\leq \pm 20\%$ of the initial value. |
| | | DF (tan δ) $\leq 150\%$ of the initial specified value. |
| | | ESR $\leq 150\%$ of the initial specified value. |
| | | Leakage current \leq The initial specified value. |
| Surge Voltage | The capacitors shall be subjected to 1,000 cycles each consisting of charge with the surge voltages specified at 105°C for 30 seconds through a protective resistor (R = 1 kΩ) and discharge for 5 minutes 30 seconds. | Appearance NO significant damage. |
| | | Capacitance change $\leq \pm 20\%$ of the initial value. |
| | | DF (tan δ) $\leq 150\%$ of the initial specified value. |
| | | ESR $\leq 150\%$ of the initial specified value. |
| | | Leakage current \leq The initial specified value. |

※ Note : If any doubt arises, measure the leakage current after following voltage treatment.
Voltage treatment : DC rated voltage are applied to the capacitors for 120 minutes at 105°C.

Frequency Coefficient for Ripple Current

| Frequency | $120\text{Hz} \leq f < 1\text{KHz}$ | $1\text{KHz} \leq f < 10\text{KHz}$ | $10\text{KHz} \leq f < 100\text{KHz}$ | $100\text{KHz} \leq f < 500\text{KHz}$ |
|-------------|-------------------------------------|-------------------------------------|---------------------------------------|--|
| Coefficient | 0.05 | 0.3 | 0.7 | 1 |

Dimensions

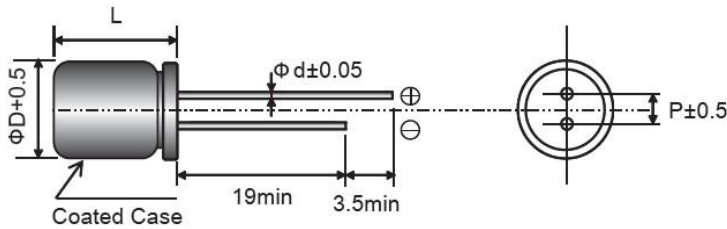

(UNIT: mm)

| Size (ΦDxL) | 5x6 | 5x8 | 6.3x6 | 6.3x8 | 6.3x11 | 8x8 | 8x12 | 10x12, 14 |
|-------------|-----------|-----------|-----------|-----------|-----------|-----------|-----------|-----------|
| ΦD | 5 | 5 | 6.3 | 6.3 | 6.3 | 8.0 | 8.0 | 10 |
| L | L+1.0 max | L+1.0 max | L+1.0 max | L+1.5 max | L+1.0 max | L+1.0 max | L+1.0 max | L+1.0 max |
| Φd | 0.45 | 0.5 | 0.45 | 0.5 | 0.5 | 0.6 | 0.6 | 0.6 |
| P | 2 | 2 | 2.5 | 2.5 | 2.5 | 3.5 | 3.5 | 5.0 |

PRA SERIES STANDARD CHARACTERISTICS LIST

| Rated Voltage (S.V.) | Cap (μF) | Size DxL | Leakage current (μA) max. ※2 | ESR (mΩ) max. 100k to 300 KHz / 20°C | Rated Ripple Current (mA rms) 100 KHz / 105°C | D.F. (tanδ) max. 120 Hz / |
|----------------------|----------|----------|------------------------------|--------------------------------------|---|---------------------------|
| 2.5 (2.9) | 390 | 6.3x6 | 300 | 35 | 2,100 | 0.12 |
| | 560 | 6.3x8 | 300 | 12 | 3,500 | 0.12 |
| | 560 | 8x8 | 300 | 12 | 4,320 | 0.12 |
| | 820 | 6.3x8 | 410 | 12 | 5,200 | 0.12 |
| | 1,200 | 8x8 | 600 | 12 | 5,200 | 0.12 |
| | 1,500 | 8x12 | 750 | 10 | 5,200 | 0.12 |
| | 2,700 | 10x12 | 1,350 | 10 | 5,230 | 0.12 |
| 4 (4.6) | 270 | 6.3x6 | 300 | 35 | 2,000 | 0.12 |
| | 560 | 6.3x8 | 448 | 15 | 3,500 | 0.12 |
| | 680 | 6.3x8 | 544 | 15 | 3,500 | 0.12 |
| | 820 | 8x8 | 656 | 13 | 5,100 | 0.12 |
| | 1,000 | 8x12 | 800 | 12 | 5,100 | 0.12 |
| | 2,200 | 10x12 | 1,760 | 12 | 5,560 | 0.12 |
| 6.3 (7.2) | 82 | 5x6 | 300 | 40 | 1,700 | 0.12 |
| | 100 | 6.3x6 | 300 | 35 | 1,900 | 0.12 |
| | 220 | 6.3x6 | 300 | 35 | 1,900 | 0.12 |
| | 470 | 6.3x8 | 592 | 15 | 3,630 | 0.12 |
| | 560 | 6.3x8 | 706 | 15 | 3,630 | 0.12 |
| | 560 | 8x8 | 706 | 15 | 4,210 | 0.12 |
| | 680 | 8x8 | 857 | 15 | 4,710 | 0.12 |
| | 1,000 | 8x12 | 1,260 | 14 | 5,100 | 0.12 |
| | 1,500 | 10x10 | 1,890 | 15 | 5,400 | 0.12 |
| 10 (11.5) | 2,200 | 10x12 | 2,772 | 15 | 5,400 | 0.12 |
| | 47 | 5x8 | 300 | 25 | 2,200 | 0.12 |
| | 220 | 5x8 | 440 | 25 | 2,200 | 0.12 |
| | 330 | 6.3x8 | 660 | 25 | 3,560 | 0.12 |
| | 680 | 8x8 | 1,360 | 25 | 3,700 | 0.12 |
| | 820 | 8x12 | 1,640 | 12 | 4,500 | 0.12 |
| 16 (18.4) | 1,500 | 10x12 | 3,000 | 12 | 5,440 | 0.12 |
| | 47 | 6.3x6 | 300 | 25 | 1,620 | 0.12 |
| | 82 | 6.3x6 | 300 | 25 | 1,890 | 0.12 |
| | 100 | 6.3x6 | 320 | 25 | 1,890 | 0.12 |
| | 270 | 6.3x8 | 864 | 15 | 2,680 | 0.12 |
| | 470 | 8x8 | 1,504 | 15 | 2,820 | 0.12 |
| | 560 | 8x12 | 1,792 | 20 | 3,640 | 0.12 |
| | 680 | 10x12 | 2,176 | 16 | 4,270 | 0.12 |
| | 820 | 10x12 | 2,624 | 16 | 4,270 | 0.12 |
| 1,000 | 10x12 | 3,200 | 16 | 4,270 | 0.12 | |

※※ 1. Capacitance tolerance : ±20% (M)

※※ 2. After 2 minutes

PRA SERIES STANDARD CHARACTERISTICS LIST

| Rated Voltage (S.V.) | Cap (μF) | Size DxL | Leakage current (μA) max. ※2 | ESR (mΩ) max. 100k to 300 KHz / 20°C | Rated Ripple Current (mA rms) 100 KHz / 105°C | D.F. (tanδ) max. 120 Hz / |
|----------------------|----------|----------|------------------------------|--------------------------------------|---|---------------------------|
| 20 (23.0) | 22 | 6.3x6 | 300 | 60 | 1,450 | 0.12 |
| | 82 | 6.3x6 | 328 | 60 | 1,450 | 0.12 |
| | 220 | 6.3x8 | 880 | 40 | 1,620 | 0.12 |
| | 330 | 8x8 | 1,320 | 40 | 2,400 | 0.12 |
| | 470 | 8x12 | 1,880 | 24 | 3,320 | 0.12 |
| | 820 | 10x12 | 3,280 | 20 | 3,800 | 0.12 |
| 25 (28.7) | 6.8 | 6.3x6 | 300 | 80 | 1,200 | 0.12 |
| | 47 | 6.3x6 | 300 | 40 | 2,000 | 0.12 |
| | 100 | 6.3x8 | 500 | 30 | 2,150 | 0.12 |
| | 180 | 8x8 | 900 | 30 | 2,580 | 0.12 |
| | 220 | 8x12 | 1,100 | 25 | 3,200 | 0.12 |
| | 330 | 10x10 | 1,650 | 28 | 3,800 | 0.12 |
| | 470 | 10x12 | 2,350 | 25 | 4,100 | 0.12 |
| | 560 | 10x14 | 2,800 | 20 | 4,500 | 0.12 |
| | 680 | 8x16 | 3,400 | 20 | 4,600 | 0.12 |
| | 820 | 10x14 | 4,100 | 20 | 5,000 | 0.12 |

※※ 1. Capacitance tolerance : ±20% (M)

※※ 2. After 2 minutes

PRB Series

- Low ESR at high frequency range
- Rated voltage : 2.5~16V
- Endurance : 2,000 hours at 105°C
- Applications: LCD Monitor, LCD-TV, D/A Inverter, SPS, D/D Converter. etc
- RoHS Compliant
- Halogen Free compliant

Specifications

| Items | Conditions | Characteristics |
|---|--|---|
| Category Temperature Range | - | -55 to +105°C |
| Rated Voltage Range | - | 2.5 ~ 16V |
| Capacitance Tolerance | at 20°C, 120 Hz | ±20% (M) |
| Surge Voltage | at 105°C | Rated voltage x 1.15v |
| Leakage Current | at 20°C after 2 minutes | I ≤ 0.2CV or 300(μA) Whichever is greater measured, after 2minutes application of rated working voltage at +20°C. Please see the attached characteristics list |
| Dissipation Factor (tan δ) | at 20°C, 120 Hz | Please see the attached characteristics list |
| Characteristics of Impedance at low, high temperature | at -55°C, 100 KHz | $Z(-55^{\circ}\text{C}) / Z(+20^{\circ}\text{C}) \leq 1.25$ |
| | at -25°C, 100 KHz | $Z(-25^{\circ}\text{C}) / Z(+20^{\circ}\text{C}) \leq 1.15$ |
| Endurance | The following specifications shall be satisfied when the capacitors are restored to 20°C after the rated voltage is applied for 2,000 hours at 105°C. | Appearance NO significant damage. |
| | | Capacitance change ≤ ±20% of the initial value. |
| | | DF (tan δ) ≤ 150% of the initial specified value. |
| | | ESR ≤ 150% of the initial specified value. |
| | | Leakage current ≤ The initial specified value. |
| Damp Heag (Steady State) | The following specifications shall be satisfied when the capacitors are restored to 20°C after subjecting them to store 60°C, 90 to 95% RH for 1,000 hours, without DC applied. | Appearance NO significant damage. |
| | | Capacitance change ≤ ±20% of the initial value. |
| | | DF (tan δ) ≤ 150% of the initial specified value. |
| | | ESR ≤ 150% of the initial specified value. |
| | | Leakage current ≤ The initial specified value. |
| Surge Voltage | The capacitors shall be subjected to 1,000 cycles each consisting of charge with the surge voltages specified at 105°C for 30 seconds through a protective resistor (R = 1 kΩ) and discharge for 5 minutes 30 seconds. | Appearance NO significant damage. |
| | | Capacitance change ≤ ±20% of the initial value. |
| | | DF (tan δ) ≤ 150% of the initial specified value. |
| | | ESR ≤ 150% of the initial specified value. |
| | | Leakage current ≤ The initial specified value. |

※ Note : If any doubt arises, measure the leakage current after following voltage treatment.
Voltage treatment : DC rated voltage are applied to the capacitors for 120 minutes at 105°C.

Frequency Coefficient for Ripple Current

| Frequency | 120Hz ≤ f < 1KHz | 1KHz ≤ f < 10KHz | 10KHz ≤ f < 100KHz | 100KHz ≤ f < 500KHz |
|-------------|------------------|------------------|--------------------|---------------------|
| Coefficient | 0.05 | 0.3 | 0.7 | 1 |

Dimensions

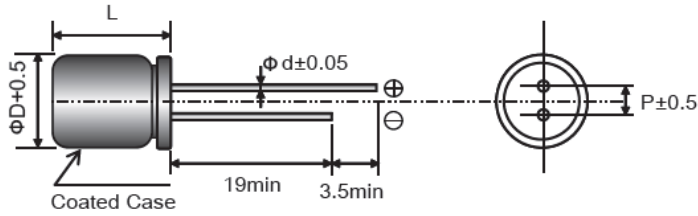

(UNIT: mm)

| ΦDxL | 5x6, 8 | 6.3x6 | 6.3x8 | 6.3x11 | 8x8 | 8x12 | 8x16 | 8x20 | 10x12 | 10x16, 20 |
|------|-----------|-----------|-----------|-----------|-----------|-----------|-----------|-----------|-----------|-----------|
| ΦD | 5 | 6.3 | 6.3 | 6.3 | 8 | 8 | 8 | 8 | 10 | 10 |
| L | L+1.0 max | L+1.0 max | L+1.5 max | L+1.0 max | L+1.5 max | L+1.0 max | L+1.0 max | L+1.5 max | L+1.0 max | L+1.5 max |
| Φd | 0.45 | 0.45 | 0.5 | 0.5 | 0.6 | 0.6 | 0.6 | 0.6 | 0.6 | 0.6 |
| P | 2 | 2.5 | 2.5 | 2.5 | 3.5 | 3.5 | 3.5 | 3.5 | 5.0 | 5.0 |

PRB SERIES STANDARD CHARACTERISTICS LIST

| Rated Voltage (S.V.) | Cap (μF) | Size DxL | Leakage current (μA) max. ※2 | ESR (mΩ) max. 100k to 300 KHz / 20°C | Rated Ripple Current (mA rms) 100 KHz / 105°C | D.F. (tanδ) max. 120 Hz / |
|----------------------|----------|----------|------------------------------|--------------------------------------|---|---------------------------|
| 2.5 (2.9) | 560 | 6.3x8 | 300 | 8 | 5,080 | 0.12 |
| | 560 | 8x8 | 300 | 7 | 5,820 | 0.12 |
| | 820 | 6.3x8 | 410 | 8 | 5,080 | 0.12 |
| | 1,200 | 8x8 | 600 | 7 | 5,580 | 0.12 |
| | 1,500 | 8x12 | 750 | 7 | 5,820 | 0.12 |
| | 2,700 | 10x12 | 1,350 | 7 | 6,100 | 0.12 |
| 4 (4.6) | 560 | 6.3x8 | 448 | 8 | 5,080 | 0.12 |
| | 560 | 8x8 | 448 | 7 | 5,580 | 0.12 |
| | 680 | 8x8 | 544 | 7 | 5,580 | 0.12 |
| | 820 | 8x12 | 656 | 7 | 5,820 | 0.12 |
| | 2200 | 10x12 | 1,760 | 7 | 6,100 | 0.12 |
| 6.3 (7.2) | 100 | 5x6 | 300 | 30 | 1,500 | 0.12 |
| | 270 | 5x8 | 340 | 15 | 2,400 | 0.12 |
| | 470 | 6.3x8 | 592 | 10 | 4,500 | 0.12 |
| | 560 | 6.3x8 | 706 | 10 | 5,080 | 0.12 |
| | 560 | 8x8 | 706 | 10 | 5,580 | 0.12 |
| | 1,000 | 8x12 | 1,260 | 7 | 5,820 | 0.12 |
| | 1,000 | 10x12 | 1,260 | 7 | 6,200 | 0.12 |
| | 2,200 | 10x12 | 2,772 | 7 | 6,200 | 0.12 |
| 10 (11.5) | 220 | 6.3x8 | 440 | 10 | 2,820 | 0.12 |
| | 270 | 6.3x8 | 540 | 10 | 3,580 | 0.12 |
| | 560 | 8x8 | 1,120 | 8 | 5,580 | 0.12 |
| | 680 | 8x8 | 1,360 | 9 | 5,580 | 0.12 |
| | 820 | 8x12 | 1,640 | 9 | 5,820 | 0.12 |
| | 1,000 | 10x12 | 2,000 | 9 | 6,100 | 0.12 |
| | 1,500 | 10x12 | 3,000 | 9 | 6,100 | 0.12 |

※※ 1. Capacitance tolerance : ±20% (M)

※※ 2. After 2 minutes

PRB SERIES STANDARD CHARACTERISTICS LIST

| Rated Voltage (S.V.) | Cap (μ F) | Size DxL | Leakage current (μ A) max. ※2 | ESR (m Ω) max. 100k to 300 KHz / 20°C | Rated Ripple Current (mA rms) 100 KHz / | D.F. (tan δ) max. 120 Hz / |
|-------------------------|-------------------|-------------|---------------------------------------|---|---|--|
| 16 (18.4) | 82 | 6.3×6 | 300 | 30 | 2,200 | 0.12 |
| | 100 | 6.3×6 | 320 | 30 | 2,20 | 0.1 |
| | 220 | 6.3×8 | 704 | 15 | 3,500 | 0.1 |
| | 270 | 6.3×8 | 864 | 15 | 3,50 | 0.1 |
| | 330 | 6.3×1 | 1,05 | 15 | 3,500 | 0.12 |
| | 470 | 8×8 | 1,50 | 13 | 4,50 | 0.1 |
| | 470 | 8×12 | 1,50 | 13 | 5,400 | .12 |
| | 470 | 10×12 | 1,504 | 13 | 6,100 | 0.1 |
| | 560 | 8x12 | 1,79 | 16 | 5,400 | 0.12 |
| | 680 | 10×12 | 2,17 | 16 | 6,10 | 0.1 |
| | 820 | 10×12 | 2,62 | 10 | 6,10 | 0.1 |
| | 100 | 8x16 | 3,20 | 10 | 6,10 | 0.1 |
| | 100 | 10×12 | 3,20 | 10 | 6,10 | 0.1 |
| | 150 | 8x20 | 4,80 | 8 | 6,10 | 0.1 |
| | 150 | 10x16 | 4,80 | 8 | 6,500 | 0.10 |
| | 1800 | 10x20 | 5,76 | 8 | 6,800 | 0.1 |
| 2200 | 10×20 | 7,04 | 8 | 6,800 | 0.10 | |

※※ 1. Capacitance tolerance : \pm 20% (M)

※※ 2. After 2 minutes

PRC Series

- Super low ESR, High ripple current capability
- Rated voltage : 2.5~50V
- Endurance : 5,000 hours at 105°C
- Applications: Servers, LCD-TV power, Inverter etc
- RoHS Compliant
- Halogen Free compliant

Specifications

| Items | Conditions | Characteristics | |
|---|--|---|--|
| Category Temperature Range | - | -55 to +105°C | |
| Rated Voltage Range | - | 2.5 ~ 50V | |
| Capacitance Tolerance | at 20°C, 120 Hz | ±20% (M) | |
| Surge Voltage | at 105°C | Rated voltage x 1.15v | |
| Leakage Current | at 20°C after 2 minutes | $I \leq 0.2CV$ or $300(\mu A)$ Whichever is greater measured, after 2minutes application of rated working voltage at +20°C. Please see the attached characteristics list | |
| Dissipation Factor (tan δ) | at 20°C, 120 Hz | Please see the attached characteristics list | |
| Characteristics of Impedance at low, high temperature | at -55°C, 100 KHz | $Z(-55^\circ C) / Z(+20^\circ C) \leq 1.25$ | |
| | at -25°C, 100 KHz | $Z(-25^\circ C) / Z(+20^\circ C) \leq 1.15$ | |
| Endurance | The following specifications shall be satisfied when the capacitors are restored to 20°C after the rated voltage is applied for 5,000 hours at 105°C. | Appearance | NO significant damage. |
| | | Capacitance change | $\leq \pm 20\%$ of the initial value. |
| | | DF (tan δ) | $\leq 150\%$ of the initial specified value. |
| | | ESR | $\leq 150\%$ of the initial specified value. |
| | | Leakage current | \leq The initial specified value. |
| Damp Heag (Steady State) | The following specifications shall be satisfied when the capacitors are restored to 20°C after subjecting them to store 60°C, 90 to 95% RH for 1,000 hours, without DC applied. | Appearance | NO significant damage. |
| | | Capacitance change | $\leq \pm 20\%$ of the initial value. |
| | | DF (tan δ) | $\leq 150\%$ of the initial specified value. |
| | | ESR | $\leq 150\%$ of the initial specified value. |
| | | Leakage current | \leq The initial specified value. |
| Surge Voltage | The capacitors shall be subjected to 1,000 cycles each consisting of charge with the surge voltages specified at 105°C for 30 seconds through a protective resistor (R = 1 kΩ) and discharge for 5 minutes 30 seconds. | Appearance | NO significant damage. |
| | | Capacitance change | $\leq \pm 20\%$ of the initial value. |
| | | DF (tan δ) | $\leq 150\%$ of the initial specified value. |
| | | ESR | $\leq 150\%$ of the initial specified value. |
| | | Leakage current | \leq The initial specified value. |

※ Note : If any doubt arises, measure the leakage current after following voltage treatment.
Voltage treatment : DC rated voltage are applied to the capacitors for 120 minutes at 105°C.

Frequency Coefficient for Ripple Current

| Frequency | $120\text{Hz} \leq f < 1\text{KHz}$ | $1\text{KHz} \leq f < 10\text{KHz}$ | $10\text{KHz} \leq f < 100\text{KHz}$ | $100\text{KHz} \leq f < 500\text{KHz}$ |
|-------------|-------------------------------------|-------------------------------------|---------------------------------------|--|
| Coefficient | 0.05 | 0.3 | 0.7 | 1 |

Dimensions

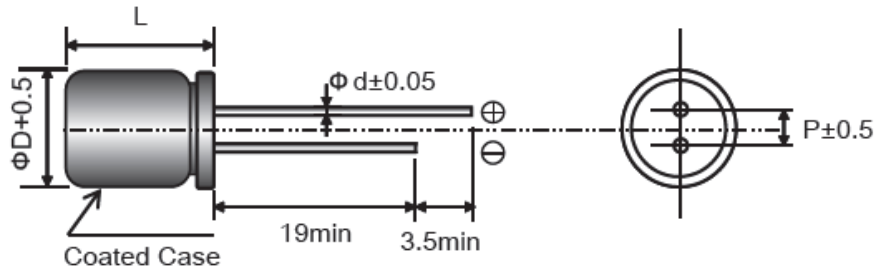

(UNIT: mm)

| ΦDxL | 5x7 | 6.3x6 | 6.3x8 | 6.3x9 | 8x8 | 8x12 | 10x10 | 10x12 |
|------|-----------|-----------|-----------|-------|-----------|-----------|-----------|-----------|
| ΦD | 5 | 6.3 | 6.3 | | 8.0 | 8.0 | 10 | 10 |
| L | L+1.0 max | L+1.0 max | L+1.5 max | | L+1.5 max | L+1.0 max | L+1.0 max | L+1.0 max |
| Φd | 0.45 | 0.45 | 0.5 | | 0.5 | 0.6 | 0.6 | 0.6 |
| P | 2 | 2.5 | 2.5 | | 2.5 | 3.5 | 5.0 | 5.0 |

PRC SERIES STANDARD CHARACTERISTICS LIST

| Rated Voltage (S.V.) | Cap (μF) | Size DxL | Leakage current (μA) max. ※2 | ESR (mΩ) max. 100k to 300 KHz / 20°C | Rated Ripple Current (mA rms) 100 KHz / 105°C | D.F. (tanδ) max. 120 Hz / 20°C |
|----------------------|----------|----------|------------------------------|--------------------------------------|---|--------------------------------|
| 2.5 (2.9) | 560 | 6.3 x8 | 300 | 7 | 5000 | 0.10 |
| | 560 | 8x8 | 300 | 7 | 5,70 | 0.12 |
| | 820 | 6.3x8 | 410 | 7 | 5000 | 0.10 |
| | 820 | 8x8 | 410 | 7 | 5,70 | 0.12 |
| | 1200 | 8x8 | 600 | 15 | 5,70 | 0.12 |
| | 1500 | 8x12 | 750 | 12 | 5,80 | 0.12 |
| 4 (4.6) | 2,70 | 10x12 | 1,350 | 12 | 6,10 | 0.12 |
| | 150 | 5x7 | 300 | 20 | 1,50 | 0.10 |
| | 220 | 5x7 | 300 | 20 | 1,50 | 0.10 |
| | 220 | 6.3x6 | 300 | 35 | 2,00 | 0.12 |
| | 560 | 6.3x8 | 448 | 20 | 5,00 | 0.12 |
| | 1000 | 8x8 | 800 | 15 | 3,64 | 0.12 |
| | 1200 | 10x10 | 960 | 10 | 5,20 | 0.12 |
| 6.3 (7.2) | 1800 | 8x12 | 1,440 | 10 | 5,20 | 0.12 |
| | 2,20 | 10x12 | 1,760 | 10 | 5,50 | 0.12 |
| | 100 | 6.3x6 | 300 | 35 | 2,00 | 0.12 |
| | 220 | 6.3x6 | 300 | 35 | 2,00 | 0.12 |
| | 330 | 6.3x8 | 415 | 20 | 2,000 | 0.12 |
| | 470 | 6.3x8 | 592 | 20 | 2,00 | 0.12 |
| | 560 | 8x8 | 705 | 15 | 3,64 | 0.12 |
| | 680 | 8x8 | 856 | 15 | 3,64 | 0.12 |
| | 1000 | 8x12 | 1,260 | 10 | 5,00 | 0.12 |
| | 1,00 | s x12 | 1,260 | 10 | 5,500 | 0.12 |
| 10 (11.5) | 1,20 | 10x10 | 1,512 | 10 | 5,50 | 0.12 |
| | 1,80 | 10x12 | 2,268 | 10 | 5,50 | 0.12 |
| | 100 | 6.3x6 | 300 | 20 | 2,000 | 0.12 |
| | 330 | 6.3x8 | 660 | 20 | 2,00 | 0.12 |
| | 560 | 8x8 | 1,120 | 15 | 3,00 | 0.12 |
| | 680 | 8x12 | 1,360 | 15 | 4,50 | 0.12 |
| | 1000 | 10x10 | 2,000 | 10 | 4,500 | 0.12 |
| | 1200 | 10x12 | 2,400 | 10 | 5,50 | 0.12 |

PRC SERIES STANDARD CHARACTERISTICS LIST

| Rated Voltage (S.V.) | Cap (μF) | Size DxL | Leakage current (μA) max. ※2 | ESR (mΩ) max. 100k to 300 KHz / 20°C | Rated Ripple Current (mA rms) 100KHz / 105°C | D.F. (tanδ) max. 120Hz / 20°C |
|----------------------|----------|----------|------------------------------|--------------------------------------|--|-------------------------------|
| 16 (18.4) | 82 | 6.3x6 | 300 | 24 | 2,400 | 0.12 |
| | 100 | 6.3x6 | 300 | 24 | 2,400 | 0.12 |
| | 220 | 6.3x8 | 704 | 24 | 2,400 | 0.12 |
| | 300 | 8x8 | 1056 | 15 | 4000 | 0.12 |
| | 470 | 8x12 | 1504 | 15 | 4500 | 0.12 |
| | 820 | 10x12 | 2624 | 15 | 4720 | 0.12 |
| | 1000 | 10x12 | 3200 | 15 | 4720 | 0.12 |
| 25 (28.75) | 47 | 6.3x6 | 300 | 40 | 1500 | 0.12 |
| | 100 | 6.3x8 | 500 | 40 | 2100 | 0.12 |
| | 180 | 8x8 | 900 | 30 | 2100 | 0.12 |
| | 22 | 8x12 | 1100 | 30 | 2300 | 0.12 |
| | 330 | 10x10 | 1650 | 25 | 2500 | 0.12 |
| | 330 | 10x12 | 1650 | 20 | 2500 | 0.12 |
| | 470 | 10x12 | 2350 | 25 | 2800 | 0.12 |
| 35 (40.25) | 22 | 6.3x6 | 300 | 70 | 1450 | 0.12 |
| | 68 | 6.3x8 | 476 | 60 | 1450 | 0.12 |
| | 100 | 8x8 | 700 | 50 | 2100 | 0.12 |
| | 120 | 8x8 | 840 | 50 | 2100 | 0.12 |
| | 150 | 8x12 | 1050 | 50 | 2100 | 0.12 |
| | 220 | 10x10 | 1540 | 40 | 2500 | 0.12 |
| | 270 | 10x12 | 1890 | 40 | 2500 | 0.12 |
| | 330 | 10x12 | 2310 | 40 | 2500 | 0.12 |
| 50 (57.5) | 12 | 6.3x6 | 300 | 100 | 660 | 0.12 |
| | 33 | 6.3x9 | 330 | 50 | 900 | 0.12 |
| | 47 | 8x8 | 470 | 45 | 1,850 | 0.12 |
| | 100 | 10x12 | 1,000 | 28 | 2,560 | 0.12 |
| | 180 | 10x12 | 1,800 | 28 | 2,560 | 0.12 |
| 63 (72.5) | 22 | 6.3x | 300 | 65 | 1,350 | 0.1 |
| | 33 | 8x8 | 415 | 40 | 1,600 | 0.1 |
| | 47 | 8x12 | 592 | 38 | 2,100 | 0.1 |
| | 56 | 10x1 | 705 | 38 | 2,100 | 0.1 |
| | 82 | 10x1 | 1,033 | 26 | 2,500 | 0.1 |
| | 100 | 10x1 | 1,260 | 26 | 2,550 | 0.1 |
| | 180 | 10x1 | 2,268 | 22 | 3,200 | 0.1 |

※ 1. Capacitance tolerance: ±20% (M)

※ 2. After 2 minutes

PRD Series

- Low ESR, High Voltage, High ripple current capability
- Rated voltage: 35~100V
- Endurance: 2,000hours at 105°C
- Applications: LED Driver, LED Power Supply, etc.
- RoHS Compliant
- Halogen Free compliant

Specifications

| Items | Conditions | Characteristics | |
|---|--|---|--|
| Category Temperature Range | - | -55 to +105°C | |
| Rated Voltage Range | - | 35 ~ 100V | |
| Capacitance Tolerance | at 20°C, 120 Hz | ±20% (M) | |
| Surge Voltage | at 105°C | Rated voltage x 1.15v | |
| Leakage Current | at 20°C after 2 minutes | $I \leq 0.2CV$ or $300(\mu A)$ Whichever is greater measured, after 2minutes application of rated working voltage at +20°C. Please see the attached characteristics list | |
| Dissipation Factor (tan δ) | at 20°C, 120 Hz | Please see the attached characteristics list | |
| Characteristics of Impedance at low, high temperature | at -55°C, 100 KHz | $Z(-55^\circ C) / Z(+20^\circ C) \leq 1.25$ | |
| | at -25°C, 100 KHz | $Z(-25^\circ C) / Z(+20^\circ C) \leq 1.15$ | |
| Endurance | The following specifications shall be satisfied when the capacitors are restored to 20°C after the rated voltage is applied for 2,000 hours at 105°C. | Appearance | NO significant damage. |
| | | Capacitance change | $\leq \pm 20\%$ of the initial value. |
| | | DF (tan δ) | $\leq 150\%$ of the initial specified value. |
| | | ESR | $\leq 150\%$ of the initial specified value. |
| | | Leakage current | \leq The initial specified value. |
| Damp Heag (Steady State) | The following specifications shall be satisfied when the capacitors are restored to 20°C after subjecting them to store 60°C, 90 to 95% RH for 1,000 hours, without DC applied. | Appearance | NO significant damage. |
| | | Capacitance change | $\leq \pm 20\%$ of the initial value. |
| | | DF (tan δ) | $\leq 150\%$ of the initial specified value. |
| | | ESR | $\leq 150\%$ of the initial specified value. |
| | | Leakage current | \leq The initial specified value. |
| Surge Voltage | The capacitors shall be subjected to 1,000 cycles each consisting of charge with the surge voltages specified at 105°C for 30 seconds through a protective resistor (R = 1 kΩ) and discharge for 5 minutes 30 seconds. | Appearance | NO significant damage. |
| | | Capacitance change | $\leq \pm 20\%$ of the initial value. |
| | | DF (tan δ) | $\leq 150\%$ of the initial specified value. |
| | | ESR | $\leq 150\%$ of the initial specified value. |
| | | Leakage current | \leq The initial specified value. |

※ Note: If any doubt arises, measure the leakage current after following voltage treatment.
Voltage treatment: DC rated voltage are applied to the capacitors for 120 minutes at 105°C.

Frequency Coefficient for Ripple Current

| Frequency | $120\text{Hz} \leq f < 1\text{KHz}$ | $1\text{KHz} \leq f < 10\text{KHz}$ | $10\text{KHz} \leq f < 100\text{KHz}$ | $100\text{KHz} \leq f < 500\text{KHz}$ |
|-------------|-------------------------------------|-------------------------------------|---------------------------------------|--|
| Coefficient | 0.05 | 0.3 | 0.7 | 1 |

Dimensions

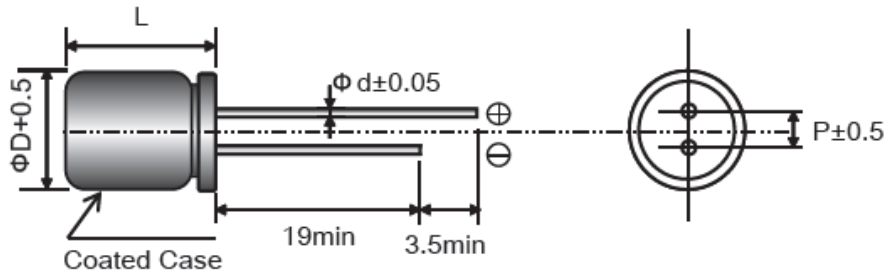

(UNIT: mm)

| ΦDxL | 6.3x6 | 6.3x8 | 8x7 | 8x8 | 8x12 | 10x10 | 10x12 | 10x16 |
|------|--------|-----------|-----------|-----------|-----------|-----------|-----------|-----------|
| ΦD | 6.3 | 6.3 | 8 | 8 | 8 | 10 | 10 | 10 |
| L | L+1max | L+1.5 max | L+1.0 max | L+1.0 max | L+1.0 max | L+1.0 max | L+1.0 max | L+1.0 max |
| Φd | 0.45 | 0.5 | 0.5 | 0.6 | 0.6 | 0.6 | 0.6 | 0.6 |
| P | 2.5 | 2.5 | 3.5 | 3.5 | 3.5 | 5.0 | 5.0 | 5.0 |

PRD SERIES STANDARD CHARACTERISTICS LIST

| Rated Voltage (S.V.) | Cap (μF) | Size DxL | Leakage current (μA) max. ※2 | ESR (mΩ) max. 100k to 300 KHz / 20°C | Rated Ripple Current (mA rms) 100 KHz / 105°C | D.F. (tanδ) max. 120 Hz / 20°C |
|----------------------|----------|----------|------------------------------|--------------------------------------|---|--------------------------------|
| 35 (40.3) | 22 | 6.3x6 | 300 | 70 | 1,450 | 0.12 |
| | 68 | 6.3x8 | 476 | 40 | 1,500 | 0.12 |
| | 82 | 8x7 | 574 | 60 | 1,800 | 0.12 |
| | 100 | 8x8 | 700 | 30 | 2,100 | 0.12 |
| | 100 | 8x12 | 700 | 26 | 2,300 | 0.12 |
| | 100 | 10x12 | 700 | 24 | 3,000 | 0.12 |
| | 150 | 8x8 | 1,050 | 30 | 2,500 | 0.12 |
| | 180 | 8x12 | 1,260 | 26 | 2,800 | 0.12 |
| | 220 | 10x10 | 1,540 | 26 | 3,000 | 0.12 |
| | 220 | 10x12 | 1,540 | 24 | 3,200 | 0.12 |
| 50 (57.5) | 330 | 10x12 | 2,310 | 24 | 3,600 | 0.12 |
| | 470 | 10x16 | 3,290 | 20 | 5,000 | 0.12 |
| | 12 | 6.3x8 | 300 | 60 | 1,500 | 0.12 |
| | 33 | 6.3x8 | 330 | 60 | 1,500 | 0.12 |
| | 33 | 8x7 | 330 | 60 | 1,500 | 0.12 |
| | 47 | 8x8 | 470 | 32 | 1,850 | 0.12 |
| | 68 | 8x12 | 680 | 30 | 2,250 | 0.12 |
| | 47 | 8x12 | 470 | 30 | 2,250 | 0.12 |
| 63 (72.5) | 100 | 10x12 | 1,000 | 28 | 2,560 | 0.12 |
| | 150 | 10x12 | 1,500 | 28 | 2,620 | 0.12 |
| | 22 | 6.3x8 | 300 | 60 | 1,500 | 0.12 |
| | 33 | 8x8 | 415 | 32 | 2,050 | 0.12 |
| | 33 | 10x10 | 415 | 32 | 2,200 | 0.12 |
| | 47 | 8x12 | 592 | 26 | 2,200 | 0.12 |
| | 56 | 10x10 | 705 | 30 | 2,300 | 0.12 |
| 80 (92.0) | 82 | 10x12 | 1,033 | 26 | 2,350 | 0.12 |
| | 100 | 10x12 | 1,260 | 25 | 2,550 | 0.12 |
| | 22 | 8x8 | 352 | 35 | 1,850 | 0.12 |
| | 33 | 8x12 | 528 | 32 | 1,950 | 0.12 |
| | 47 | 10x10 | 752 | 33 | 2,200 | 0.12 |
| 100 (115.0) | 68 | 10x12 | 1,088 | 28 | 2,350 | 0.12 |
| | 15 | 8x12 | 300 | 40 | 1,850 | 0.12 |
| | 22 | 10x12 | 440 | 38 | 2,250 | 0.12 |
| | 27 | 10x12 | 540 | 38 | 2,250 | 0.12 |

※ 1. Capacitance tolerance : ±20% (M)

※ 2. After 2 minutes

PRE Series

- High temperature, low ESR, High ripple current capability
- Rated voltage: 4~50V
- Endurance: 1,000hours at 125°C
- Applications: DC-DC Converters, Voltage Regulators, Decoupling
- Applications for Computer Motherboards, etc.
- RoHS Compliant
- Halogen Free compliant

Specifications

| Items | Conditions | Characteristics | |
|---|--|---|--|
| Category Temperature Range | - | -55 to +125°C | |
| Rated Voltage Range | - | 4 ~ 50V | |
| Capacitance Tolerance | at 20°C, 120 Hz | ±20% (M) | |
| Surge Voltage | at 125°C | Rated voltage x 1.15v | |
| Leakage Current | at 20°C after 2 minutes | $I \leq 0.2CV$ or $300(\mu A)$ Whichever is greater measured, after 2minutes application of rated working voltage at +20°C. Please see the attached characteristics list | |
| Dissipation Factor (tan δ) | at 20°C, 120 Hz | Please see the attached characteristics list | |
| Characteristics of Impedance at low, high temperature | at -55°C, 100KHz | $Z(-55^\circ C)/Z(+20^\circ C) \leq 1.25$ | |
| | at -25°C,100KHz | $Z(-25^\circ C)/Z(+20^\circ C) \leq 1.15$ | |
| Endurance | The following specifications shall be satisfied when the capacitors are restored to 20°C after the rated voltage is applied for 1,000 hours at 125°C. | Appearance | NO significant damage. |
| | | Capacitance change | $\leq \pm 20\%$ of the initial value. |
| | | DF (tan δ) | $\leq 150\%$ of the initial specified value. |
| | | ESR | $\leq 150\%$ of the initial specified value. |
| | | Leakage current | \leq The initial specified value. |
| Damp Heag (Steady State) | The following specifications shall be satisfied when the capacitors are restored to 20°C after subjecting them to store 60°C, 90 to 95% RH for 1,000 hours, without DC applied. | Appearance | NO significant damage. |
| | | Capacitance change | $\leq \pm 20\%$ of the initial value. |
| | | DF (tan δ) | $\leq 150\%$ of the initial specified value. |
| | | ESR | $\leq 150\%$ of the initial specified value. |
| | | Leakage current | \leq The initial specified value. |
| Surge Voltage | The capacitors shall be subjected to 1,000 cycles each consisting of charge with the surge voltages specified at 105°C for 30 seconds through a protective resistor (R = 1 kΩ) and discharge for 5 minutes 30 seconds. | Appearance | NO significant damage. |
| | | Capacitance change | $\leq \pm 20\%$ of the initial value. |
| | | DF (tan δ) | $\leq 150\%$ of the initial specified value. |
| | | ESR | $\leq 150\%$ of the initial specified value. |
| | | Leakage current | \leq The initial specified value. |

※ Note : If any doubt arises, measure the leakage current after following voltage treatment.
Voltage treatment : DC rated voltage are applied to the capacitors for 120 minutes at 125°C.

Frequency Coefficient for Ripple Current

| Frequency | $120\text{Hz} \leq f < 1\text{KHz}$ | $1\text{KHz} \leq f < 10\text{KHz}$ | $10\text{KHz} \leq f < 100\text{KHz}$ | $100\text{KHz} \leq f < 500\text{KHz}$ |
|-------------|-------------------------------------|-------------------------------------|---------------------------------------|--|
| Coefficient | 0.05 | 0.3 | 0.7 | 1 |

Dimensions

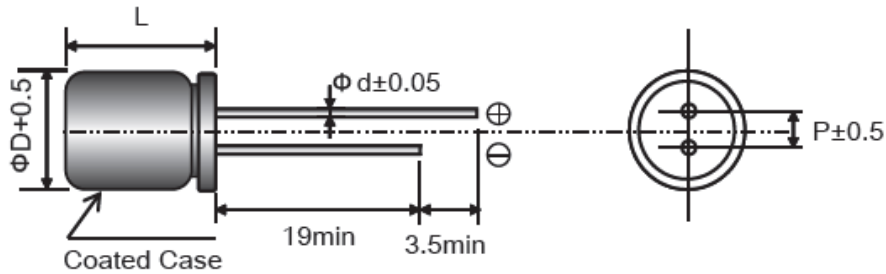

(UNIT: mm)

| ΦDxL | 6.3x6 | 6.3x8 | 8x7 | 8x8 | 8x12 | 10x10 | 10x12 |
|------|-----------|-----------|-----------|-----------|-----------|-----------|-----------|
| ΦD | 6.3 | 6.3 | 8 | 8 | 8 | 10 | 10 |
| L | L+1.0 max | L+1.5 max | L+1.0 max | L+1.5 max | L+1.0 max | L+1.0 max | L+1.0 max |
| Φd | 0.45 | 0.5 | 0.5 | 0.6 | 0.6 | 0.6 | 0.6 |
| P | 2.5 | 2.5 | 3.5 | 3.5 | 3.5 | 5.0 | 5.0 |

PRE SERIES STANDARD CHARACTERISTICS LIST

| Rated Voltage (S.V.) | Cap (μF) | Size DxL | Leakage current (μA) max. ※2 | ESR (mΩ) max. 100k to 300 KHz / 20°C | Rated Ripple Current (mA rms) | | D.F. (tanδ) max. 120 Hz / 20°C |
|----------------------|----------|----------|------------------------------|--------------------------------------|-------------------------------|---------------|--------------------------------|
| | | | | | 105°C 100 KHz | 125°C 100 KHz | |
| 4 (4.6) | 100 | 6.3x6 | 300 | 40 | 2390 | 797 | 0.12 |
| | 330 | 6.3x8 | 300 | 20 | 3200 | 1067 | 0.12 |
| | 560 | 6.3x8 | 448 | 20 | 3200 | 1067 | 0.12 |
| | 1,000 | 8x8 | 800 | 20 | 3800 | 1267 | 0.12 |
| | 1,200 | 8x12 | 960 | 16 | 4200 | 1400 | 0.12 |
| | 2,500 | 10x12 | 2,000 | 16 | 5460 | 1820 | 0.12 |
| 6.3 (7.2) | 100 | 6.3x6 | 300 | 40 | 2100 | 700 | 0.12 |
| | 470 | 6.3x8 | 592 | 20 | 3100 | 1033 | 0.12 |
| | 560 | 8x8 | 705 | 20 | 4300 | 1433 | 0.12 |
| | 1,000 | 8x12 | 1,260 | 16 | 5100 | 1700 | 0.12 |
| | 1,200 | 8x12 | 1,512 | 16 | 5100 | 1700 | 0.12 |
| | 1,500 | 10x10 | 1,890 | 20 | 5200 | 1733 | 0.12 |
| | 1,800 | 10x12 | 2,268 | 16 | 5440 | 1813 | 0.12 |
| 10 (11.5) | 100 | 6.3x6 | 300 | 40 | 1800 | 600 | 0.12 |
| | 330 | 6.3x8 | 660 | 20 | 2360 | 787 | 0.12 |
| | 330 | 8x7 | 660 | 40 | 2560 | 853 | 0.12 |
| | 560 | 8x8 | 1,120 | 20 | 3200 | 1067 | 0.12 |
| | 820 | 8x12 | 1,640 | 16 | 4200 | 1400 | 0.12 |
| | 1,000 | 10x10 | 2,000 | 20 | 5120 | 1707 | 0.12 |
| | 1,200 | 10x12 | 2,400 | 16 | 5600 | 1867 | 0.12 |
| 16 (18.4) | 47 | 6.3x6 | 300 | 30 | 1620 | 540 | 0.12 |
| | 82 | 6.3x6 | 300 | 30 | 1620 | 540 | 0.12 |
| | 100 | 6.3x8 | 320 | 20 | 2120 | 707 | 0.12 |
| | 330 | 8x8 | 1,056 | 20 | 4300 | 1433 | 0.12 |
| | 470 | 8x12 | 1,504 | 16 | 4500 | 1500 | 0.12 |
| | 560 | 10x12 | 1,792 | 16 | 4700 | 1567 | 0.12 |
| | 820 | 10x12 | 2,624 | 16 | 4700 | 1567 | 0.12 |
| 25 (28.8) | 47 | 6.3x6 | 300 | 50 | 2000 | 667 | 0.12 |
| | 100 | 6.3x8 | 500 | 30 | 2000 | 667 | 0.12 |
| | 180 | 8x8 | 900 | 28 | 3100 | 1033 | 0.12 |
| | 220 | 8x12 | 1,100 | 26 | 3600 | 1200 | 0.12 |
| | 330 | 10x12 | 1,650 | 24 | 4250 | 1417 | 0.12 |
| | 470 | 10x12 | 2,350 | 24 | 4200 | 1400 | 0.12 |

PRE SERIES STANDARD CHARACTERISTICS LIST

| Rated Voltage (S.V.) | Cap (μ F) | Size DxL | Leakage current (μ A) max. ※2 | ESR (m Ω) max. 100k to 300 KHz / 20°C | Rated Ripple Current (mA rms) | | D.F. (tan δ) max. 120 Hz / 20°C |
|-------------------------|-------------------|-------------|---------------------------------------|---|----------------------------------|------------------|--|
| | | | | | 105°C 100 KHz | 125°C 100 KHz | |
| 35 (40.3) | 22 | 6.3x6 | 300 | 70 | 1450 | 483 | 0.12 |
| | 68 | 6.3x8 | 476 | 60 | 1500 | 500 | 0.12 |
| | 120 | 8x8 | 840 | 30 | 2200 | 733 | 0.12 |
| | 150 | 8x12 | 1,050 | 28 | 2600 | 867 | 0.12 |
| | 220 | 10x10 | 1,540 | 28 | 2950 | 983 | 0.12 |
| | 270 | 10x12 | 1,890 | 28 | 3200 | 1067 | 0.12 |
| 50 (57.5) | 10 | 6.3x6 | 300 | 60 | 1400 | 467 | 0.12 |
| | 33 | 6.3x8 | 330 | 60 | 1500 | 500 | 0.12 |
| | 47 | 8x8 | 470 | 30 | 2000 | 667 | 0.12 |
| | 68 | 8x12 | 680 | 28 | 2200 | 733 | 0.12 |
| | 100 | 10x10 | 1,000 | 28 | 2300 | 767 | 0.12 |
| | 100 | 10x12 | 1,000 | 28 | 2500 | 833 | 0.12 |

※ 1. Capacitance tolerance : \pm 20% (M)

※ 2. After 2 minutes

PRF Series

- High temperature, low ESR, High ripple current capability
- Rated voltage: 6.3~35V
- Endurance: 2,000hours at 125°C
- Applications: Lamps Power, LED Power, Service Equipment
- RoHS Compliant
- Halogen Free compliant

Specifications

| Items | Conditions | Characteristics |
|---|---|---|
| Category Temperature Range | - | -55 to +125°C |
| Rated Voltage Range | - | 6.3 ~ 35V |
| Capacitance Tolerance | at 20°C, 120 Hz | ±20% (M) |
| Surge Voltage | at 125°C | Rated voltage x 1.15v |
| Leakage Current | at 20°C after 2 minutes | $I \leq 0.2CV$ or $300(\mu A)$ Whichever is greater measured, after 2minutes application of rated working voltage at +20°C. Please see the attached characteristics list |
| Dissipation Factor (tan δ) | at 20°C, 120 Hz | Please see the attached characteristics list |
| Characteristics of Impedance at low, high temperature | at -55°C, 100 KHz | $Z (-55^\circ C) / Z (+20^\circ C) \leq 1.25$ |
| | at +25°C, 100 KHz | $Z (-25^\circ C) / Z (+20^\circ C) \leq 1.15$ |
| Endurance | The following specifications shall be satisfied when the capacitors are restored to 20°C after the rated voltage is applied for 2,000 hours at 125°C. | Appearance NO significant damage. |
| | | Capacitance change $\leq \pm 20\%$ of the initial value. |
| | | DF (tan δ) $\leq 150\%$ of the initial specified value. |
| | | ESR $\leq 150\%$ of the initial specified value. |
| | | Leakage current \leq The initial specified value. |
| Damp Heag (Steady State) | The following specifications shall be satisfied when the capacitors are restored to 20°C after subjecting them to store 60°C, 90 to 95% RH for 1,000 hours, without DC applied. | Appearance NO significant damage. |
| | | Capacitance change $\leq \pm 20\%$ of the initial value. |
| | | DF (tan δ) $\leq 150\%$ of the initial specified value. |
| | | ESR $\leq 150\%$ of the initial specified value. |
| | | Leakage current \leq The initial specified value. |
| Surge Voltage | The capacitors shall be subjected to 1,000 cycles each consisting of charge with the surge voltages specified at 105°C for 30 seconds through a protective resistor (R = 1 k Ω) and discharge for 5 minutes 30 seconds. | Appearance NO significant damage. |
| | | Capacitance change $\leq \pm 20\%$ of the initial value. |
| | | DF (tan δ) $\leq 150\%$ of the initial specified value. |
| | | ESR $\leq 150\%$ of the initial specified value. |
| | | Leakage current \leq The initial specified value. |

※ Note : If any doubt arises, measure the leakage current after following voltage treatment.
Voltage treatment : DC rated voltage are applied to the capacitors for 120 minutes at 125°C.

Frequency Coefficient for Ripple Current

| Frequency | 120Hz $\leq f < 1$ KHz | 1KHz $\leq f < 10$ KHz | 10KHz $\leq f < 100$ KHz | 100KHz $\leq f < 500$ KHz |
|-------------|------------------------|------------------------|--------------------------|---------------------------|
| Coefficient | 0.05 | 0.3 | 0.7 | 1 |

Dimensions

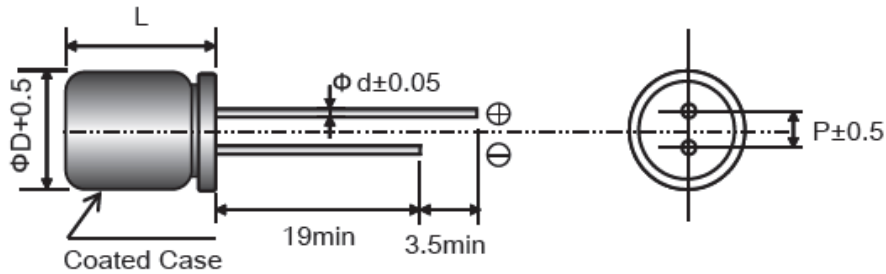

(UNIT: mm)

| $\Phi D \times L$ | 6.3x8 | 8x8 | 8x12 | 10x10 | 10x12 |
|-------------------|-----------|-----------|-----------|-----------|-----------|
| ΦD | 6.3 | 8.0 | 8.0 | 10 | 10 |
| L | L+1.5 max | L+1.5 max | L+1.0 max | L+1.0 max | L+1.0 max |
| Φd | 0.5 | 0.6 | 0.6 | 0.6 | 0.6 |
| P | 2.5 | 3.5 | 3.5 | 5.0 | 5.0 |

PRF SERIES STANDARD CHARACTERISTICS LIST

| Rated Voltage (S.V.) | Cap (μF) | Size DxL | Leakage current (μA) max. ※2 | ESR (mΩ) max. 100k to 300 KHz / 20°C | Rated Ripple Current (mA rms) | | D.F. (tanδ) max. 120Hz / 20°C |
|----------------------|----------|----------|------------------------------|--------------------------------------|-------------------------------|--------------|-------------------------------|
| | | | | | 105°C 100kHz | 125°C 100kHz | |
| 6.3 (7.2) | 470 | 6.3x8 | 592 | 25 | 3,800 | 1,267 | 0.12 |
| | 680 | 8x8 | 857 | 25 | 4,000 | 1,333 | 0.12 |
| | 1,000 | 8x12 | 1,260 | 20 | 4,200 | 1,400 | 0.12 |
| | 1,200 | 10x10 | 1,512 | 25 | 5,500 | 1,833 | 0.12 |
| | 1,800 | 10x12 | 2,268 | 20 | 6,100 | 2,033 | 0.12 |
| 10 (11.5) | 330 | 6.3x8 | 660 | 25 | 3,700 | 1,233 | 0.12 |
| | 560 | 8x8 | 1,120 | 25 | 4,000 | 1,333 | 0.12 |
| | 680 | 8x12 | 1,360 | 20 | 4,500 | 1,500 | 0.12 |
| | 820 | 10x10 | 1,640 | 25 | 4,200 | 1,400 | 0.12 |
| | 1,000 | 10x10 | 2,000 | 25 | 4,500 | 1,500 | 0.12 |
| | 1,200 | 10x12 | 2,400 | 20 | 5,600 | 1,867 | 0.12 |
| 16 (18.4) | 220 | 6.3x8 | 704 | 25 | 2,850 | 950 | 0.12 |
| | 330 | 8x8 | 1,056 | 25 | 4,000 | 1,333 | 0.12 |
| | 470 | 8x12 | 1,504 | 20 | 4,500 | 1,500 | 0.12 |
| | 680 | 10x10 | 2,176 | 25 | 5,100 | 1,700 | 0.12 |
| | 820 | 10x12 | 2,624 | 20 | 5,600 | 1,867 | 0.12 |
| 20 (23.0) | 120 | 6.3x8 | 480 | 25 | 2,510 | 837 | 0.12 |
| | 220 | 8x8 | 880 | 25 | 2,750 | 917 | 0.12 |
| | 270 | 8x12 | 1,080 | 20 | 2,950 | 983 | 0.12 |
| | 330 | 10x10 | 1,320 | 25 | 4,700 | 1,567 | 0.12 |
| | 470 | 10x12 | 1,880 | 20 | 4,950 | 1,650 | 0.12 |
| 25 (28.8) | 100 | 6.3x8 | 500 | 40 | 2,380 | 793 | 0.12 |
| | 180 | 8x8 | 900 | 30 | 2,900 | 967 | 0.12 |
| | 220 | 8x8 | 1,100 | 28 | 3,500 | 1,167 | 0.12 |
| | 330 | 10x10 | 1,650 | 30 | 4,250 | 1,417 | 0.12 |
| | 470 | 10x12 | 2,350 | 28 | 4,500 | 1,500 | 0.12 |
| 35 (40.3) | 56 | 6.3x8 | 392 | 60 | 2,300 | 767 | 0.12 |
| | 100 | 8x8 | 700 | 50 | 2,500 | 833 | 0.12 |
| | 120 | 8x12 | 840 | 30 | 2,950 | 983 | 0.12 |
| | 150 | 10x10 | 1,050 | 30 | 2,950 | 983 | 0.12 |
| | 220 | 10x12 | 1,540 | 28 | 3,400 | 1,133 | 0.12 |

※ 1. Capacitance tolerance : ±20% (M)

※ 2. After 2 minutes

PRG Series

- Super low ESR, High ripple current capability
- Rated Voltage: 2.5 ~ 50V
- Endurance: 20,000 hours at 105°C
- Applications: Servers, LCD-TV power, Inverter etc.
- RoHS Compliant
- Halogen Free compliant

Specifications

| Items | Conditions | Characteristics | |
|---|---|--|--|
| Category Temperature Range | - | -55 to +105°C | |
| Rated Voltage Range | - | 2.5 ~ 50V | |
| Capacitance Tolerance | at 20°C, 120 Hz | ±20% (M) | |
| Surge Voltage | at 105°C | Rated voltage x 1.15V | |
| Leakage Current | at 20°C after 2 minutes | $I \leq 0.2CV$ or $300(\mu A)$ Whichever is greater measured, after 2 minutes application of rated working voltage at +20°C. | |
| Dissipation Factor (tan δ) | at 20°C, 120 Hz | Please see the attached characteristics list | |
| Characteristics of Impedance at low, high temperature | at -55°C, 100kHz | $Z(-55^\circ C)/Z(+20^\circ C) \leq 1.25$ | |
| | at -25°C, 100kHz | $Z(-25^\circ C)/Z(+20^\circ C) \leq 1.15$ | |
| Endurance | The following specifications shall be satisfied when the capacitors are restored to 20°C after the rated voltage is applied for 20,000 hours at 105°C. | Appearance | NO significant damage. |
| | | Capacitance change | $\leq \pm 20\%$ of the initial value. |
| | | DF (tan δ) | $\leq 150\%$ of the initial specified value. |
| | | ESR | $\leq 150\%$ of the initial specified value. |
| | | Leakage current | \leq The initial specified value. |
| Damp Heat (Steady State) | The following specifications shall be satisfied when the capacitors are restored to 20°C after subjecting them to store at 60°C, 90 to 95% RH for 1,000 hours, without DC applied. | Appearance | NO significant damage. |
| | | Capacitance change | $\leq \pm 20\%$ of the initial value. |
| | | DF (tan δ) | $\leq 150\%$ of the initial specified value. |
| | | ESR | $\leq 150\%$ of the initial specified value. |
| | | Leakage current | \leq The initial specified value. |
| Surge Voltage | The capacitors shall be subjected to 1,000 cycles each consisting of charge with the surge voltages specified at 105°C for 30 seconds through a protective resistor (R=1 k Ω) and discharge for 5 minutes 30 seconds. | Appearance | NO significant damage. |
| | | Capacitance change | $\leq \pm 20\%$ of the initial value. |
| | | DF (tan δ) | $\leq 150\%$ of the initial specified value. |
| | | ESR | $\leq 150\%$ of the initial specified value. |
| | | Leakage current | \leq The initial specified value. |

※ Note: If any doubt arises, measure the leakage current after following voltage treatment.
Voltage treatment: DC rated voltage are applied to the capacitors for 120 minutes at 105°C.

Frequency Coefficient for Ripple Current

| Frequency | 120Hz $\leq f < 1$ kHz | 1kHz $\leq f < 10$ kHz | 10kHz $\leq f < 100$ kHz | 100kHz $\leq f < 500$ kHz |
|-------------|------------------------|------------------------|--------------------------|---------------------------|
| Coefficient | 0.05 | 0.3 | 0.7 | 1 |

DIMENSIONS

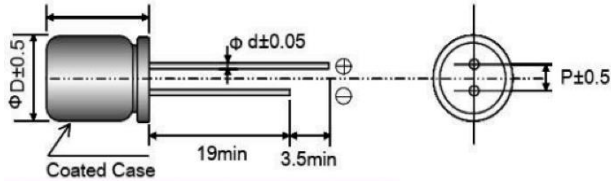

(Unit: mm)

| Size Code | 6.3×6 | 6.3×9 | 8×8 | 8×12 | 10×10 | 10×12 |
|-----------|-----------|-----------|-----------|-----------|-----------|-----------|
| ΦD | 6.3 | 6.3 | 8 | 8 | 10 | 10 |
| L | L+1.0 max | L+1.0 max | L+1.5 max | L+1.0 max | L+1.0 max | L+1.0 max |
| Φd | 0.5 | 0.5 | 0.6 | 0.6 | 0.6 | 0.6 |
| P | 2.5 | 2.5 | 3.5 | 3.5 | 5.0 | 5.0 |

PRG SERIES STANDARD CHARACTERISTICS LIST

| Rated Voltage (S.V.) | Cap (μF) | Size DxL | Leakage current (μA) max ※2 | ESR (mΩ) max. 100k to 300kHz / 20°C | Rated Ripple Current (mA rms) 100 kHz / 105°C | D.F. (tan δ) max. 120Hz / 20°C |
|----------------------|----------|----------|-----------------------------|-------------------------------------|---|--------------------------------|
| 2.5 (2.9) | 220 | 6.3 x6 | 300 | 24 | 2,400 | 0.12 |
| | 560 | 6.3x9 | 300 | 15 | 3,200 | 0.12 |
| | 1000 | 8x8 | 500 | 15 | 3,640 | 0.12 |
| | 1200 | 8x12 | 600 | 10 | 5,200 | 0.12 |
| | 1800 | 10x12 | 900 | 10 | 5,200 | 0.12 |
| | 2,200 | 10x12 | 1,100 | 10 | 5,500 | 0.12 |
| 6.3 (7.2) | 100 | 6.3x6 | 300 | 24 | 2,400 | 0.12 |
| | 180 | 6.3x6 | 300 | 24 | 2,400 | 0.12 |
| | 470 | 6.3×9 | 592 | 20 | 3,500 | 0.12 |
| | 560 | 6.3x9 | 706 | 20 | 3,500 | 0.12 |
| | 560 | 8×8 | 706 | 15 | 4,100 | 0.12 |
| | 680 | 8x8 | 856 | 15 | 4,300 | 0.12 |
| | 1000 | 8×12 | 1,260 | 12 | 5,000 | 0.12 |
| | 1,200 | 10x10 | 1,512 | 15 | 5,200 | 0.12 |
| 10 (11.5) | 120 | 6.3×6 | 300 | 24 | 2,400 | 0.12 |
| | 330 | 6.3x9 | 660 | 15 | 3,500 | 0.12 |
| | 560 | 8x8 | 1,120 | 15 | 4,000 | 0.12 |
| | 680 | 8x12 | 1,360 | 15 | 4,800 | 0.12 |
| | 1000 | 10x10 | 2,000 | 15 | 4,800 | 0.12 |
| | 1200 | 10x12 | 2,400 | 12 | 5,500 | 0.12 |
| 16 (18.4) | 82 | 6.3x6 | 300 | 24 | 2,400 | 0.12 |
| | 100 | 6.3x9 | 320 | 15 | 3500 | 0.12 |
| | 220 | 6.3x9 | 704 | 15 | 3500 | 0.12 |
| | 330 | 8x8 | 1056 | 15 | 4200 | 0.12 |
| | 470 | 8x12 | 1504 | 12 | 4500 | 0.12 |
| | 470 | 10x12 | 1504 | 10 | 5100 | 0.12 |
| | 680 | 10x10 | 2176 | 15 | 5100 | 0.12 |
| | 820 | 10x12 | 2624 | 15 | 5400 | 0.12 |
| | 1000 | 10x12 | 3200 | 15 | 5400 | 0.12 |

| Rated Voltage (S.V.) | Cap (μF) | Size DxL | Leakage current (μA) max ※2 | ESR (mΩ) max. 100k to 300kHz / 20°C | Rated Ripple Current (mA rms) 100 kHz / 105°C | D.F. (tan δ) max. 120Hz / 20°C |
|----------------------|----------|----------|-----------------------------|-------------------------------------|---|--------------------------------|
| 25 (28.8) | 47 | 6.3x6 | 300 | 40 | 1500 | 0.12 |
| | 100 | 6.3x9 | 500 | 30 | 2500 | 0.12 |
| | 180 | 8x8 | 900 | 30 | 3260 | 0.12 |
| | 220 | 8x12 | 1100 | 30 | 3520 | 0.12 |
| | 330 | 10x10 | 1650 | 20 | 3850 | 0.12 |
| | 470 | 10x12 | 2350 | 25 | 4020 | 0.12 |
| 35 (40.3) | 22 | 6.3x6 | 300 | 70 | 1450 | 0.12 |
| | 68 | 6.3x9 | 476 | 60 | 1520 | 0.12 |
| | 120 | 8x8 | 840 | 30 | 2100 | 0.12 |
| | 150 | 8x12 | 1050 | 26 | 2800 | 0.12 |
| | 220 | 10x10 | 1540 | 30 | 3050 | 0.12 |
| | 270 | 10x12 | 1890 | 26 | 3650 | 0.12 |
| 50 (57.5) | 10 | 6.3x6 | 300 | 90 | 900 | 0.12 |
| | 33 | 6.3x9 | 330 | 60 | 1500 | 0.12 |
| | 47 | 8x8 | 470 | 32 | 2000 | 0.12 |
| | 68 | 8x12 | 680 | 28 | 2200 | 0.12 |
| | 100 | 10x10 | 1000 | 32 | 2350 | 0.12 |
| | 100 | 10x12 | 1000 | 28 | 2550 | 0.12 |

※ 1. Capacitance tolerance: ±20%(M)

※ 2. After 2 minutes

PRH Series

- Low ESR at high frequency range
- Rated Voltage: 2.5 ~ 63V
- Endurance: 15,000 hours at 105°C
- Applications: LCD Monitor, LCD-TV, D/A Inverter, SPS, D/D Converter, etc.,
- RoHS Compliant
- Halogen Free compliant

Specifications

| Items | Conditions | Characteristics | |
|---|---|--|--|
| Category Temperature Range | - | -55 to +105°C | |
| Rated Voltage Range | - | 2.5 ~ 63V | |
| Capacitance Tolerance | at 20°C, 120 Hz | ±20% (M) | |
| Surge Voltage | at 105°C | Rated voltage x 1.15V | |
| Leakage Current | at 20°C after 2 minutes | $I \leq 0.2CV$ or $300(\mu A)$ Whichever is greater measured, after 2 minutes application of rated working voltage at +20°C. | |
| Dissipation Factor (tan δ) | at 20°C, 120 Hz | Please see the attached characteristics list | |
| Characteristics of Impedance at low, high temperature | at -55°C, 100kHz | $Z(-55^\circ C)/Z(+20^\circ C) \leq 1.25$ | |
| | at -25°C, 100kHz | $Z(-25^\circ C)/Z(+20^\circ C) \leq 1.15$ | |
| Endurance | The following specifications shall be satisfied when the capacitors are restored to 20°C after the rated voltage is applied for 15,000 hours at 105°C. | Appearance | NO significant damage. |
| | | Capacitance change | $\leq \pm 20\%$ of the initial value. |
| | | DF (tan δ) | $\leq 150\%$ of the initial specified value. |
| | | ESR | $\leq 150\%$ of the initial specified value. |
| | | Leakage current | \leq The initial specified value. |
| Damp Heag (Steady State) | The following specifications shall be satisfied when the capacitors are restored to 20°C after subjecting them to store at 60°C, 90 to 95% RH for 1,000 hours, without DC applied. | Appearance | NO significant damage. |
| | | Capacitance change | $\leq \pm 20\%$ of the initial value. |
| | | DF (tan δ) | $\leq 150\%$ of the initial specified value. |
| | | ESR | $\leq 150\%$ of the initial specified value. |
| | | Leakage current | \leq The initial specified value. |
| Surge Voltage | The capacitors shall be subjected to 1,000 cycles each consisting of charge with the surge voltages specified at 105°C for 30 seconds through a protective resistor (R=1 k Ω) and discharge for 5 minutes 30 seconds. | Appearance | NO significant damage. |
| | | Capacitance change | $\leq \pm 20\%$ of the initial value. |
| | | DF (tan δ) | $\leq 150\%$ of the initial specified value. |
| | | ESR | $\leq 150\%$ of the initial specified value. |
| | | Leakage current | \leq The initial specified value. |

※ Note: If any doubt arises, measure the leakage current after following voltage treatment.
Voltage treatment: DC rated voltage are applied to the capacitors for 120 minutes at 105°C.

Frequency Coefficient for Ripple Current

| Frequency | $120\text{Hz} \leq f < 1\text{kHz}$ | $1\text{kHz} \leq f < 10\text{kHz}$ | $10\text{kHz} \leq f < 100\text{kHz}$ | $100\text{kHz} \leq f < 500\text{kHz}$ |
|-------------|-------------------------------------|-------------------------------------|---------------------------------------|--|
| Coefficient | 0.05 | 0.3 | 0.7 | 1 |

DIMENSIONS

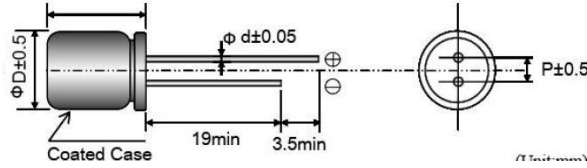

(Unit: mm)

| Size Code | 5x6 | 6.3x6 | 6.3x9 | 6.3x11 | 8x8 | 8x12 | 8x14 | 8x16 | 8x20 | 10x12 | 10x14 | 10x16 |
|-----------|-----------|-----------|---------|-----------|-----------|-----------|-----------|-----------|-----------|-----------|-----------|-----------|
| ΦD | 5 | 6.3 | 6.3 | 6.3 | 8 | 8 | 8 | 8 | 8 | 10.0 | 10.0 | 10.0 |
| L | L+1.0 max | L+1.0 max | L+1 max | L+1.0 max | L+1.5 max | L+1.0 max | L+1.0 max | L+1.0 max | L+1.5 max | L+1.0 max | L+1.0 max | L+1.5 max |
| Φd | 0.45 | 0.45 | 0.5 | 0.5 | 0.6 | 0.6 | 0.6 | 0.6 | 0.6 | 0.6 | 0.6 | 0.6 |
| P | 2 | 2.5 | 2.5 | 2.5 | 3.5 | 3.5 | 3.5 | 3.5 | 3.5 | 5.0 | 5.0 | 5.0 |

PRH SERIES STANDARD CHARACTERISTICS LIST

| Rated Voltage (S.V.) | Cap (μF) | Size DxL | Leakage current (μA) max. $\times 2$ | ESR (m Ω) max. 100k to 300kHz / 20°C | Rated Ripple Current (mA rms) 100kHz / 105°C | D.F. (tan δ) max 120Hz / 20°C |
|----------------------|-----------------|----------|---|--|--|---------------------------------------|
| 2.5 (2.9) | 560 | 6.3x9 | 300 | 8 | 5,080 | 0.12 |
| | 560 | 8x5 | 300 | 7 | 5,820 | 0.12 |
| | 820 | 6.3x9 | 410 | 8 | 5,080 | 0.12 |
| | 1200 | 8x8 | 600 | 7 | 5,580 | 0.12 |
| | 1500 | 8x12 | 750 | 7 | 5,820 | 0.12 |
| | 2,700 | 10x12 | 1,350 | 7 | 6,100 | 0.12 |
| 4 (4.6) | 560 | 6.3x9 | 448 | 8 | 5,080 | 0.12 |
| | 560 | 8x8 | 448 | 7 | 5,580 | 0.12 |
| | 680 | 8x8 | 544 | 7 | 5,580 | 0.12 |
| | 820 | 8x12 | 656 | 7 | 5,820 | 0.12 |
| | 2200 | 10x12 | 1,760 | 7 | 6,100 | 0.12 |
| 6.3 (7.2) | 100 | 5x6 | 300 | 13 | 1,500 | 0.12 |
| | 220 | 5x8 | 300 | 12 | 2,400 | 0.12 |
| | 470 | 6.3x9 | 592 | 10 | 4,500 | 0.12 |
| | 560 | 6.3x9 | 706 | 10 | 5,080 | 0.12 |
| | 560 | 8x8 | 706 | 10 | 5,580 | 0.12 |
| | 1,000 | 8x12 | 1,260 | 7 | 5,820 | 0.12 |
| | 1,000 | 10x12 | 1,260 | 7 | 6,200 | 0.12 |
| | 2,200 | 10x12 | 2,772 | 7 | 6,200 | 0.12 |
| 10 (11.5) | 220 | 6.3x9 | 440 | 10 | 2,820 | 0.12 |
| | 270 | 6.3x9 | 540 | 10 | 5,580 | 0.12 |
| | 560 | 8x8 | 1,120 | 8 | 5,580 | 0.12 |
| | 680 | 8x8 | 1,360 | 9 | 5,580 | 0.12 |
| | 820 | 8x12 | 1,640 | 9 | 5,820 | 0.12 |
| | 1,000 | 10x12 | 2,000 | 9 | 6,100 | 0.12 |
| | 1500 | 10x12 | 3,000 | 9 | 6,100 | 0.12 |

| Rated Voltage (S.V.) | Cap (μF) | Size DxL | Leakage current (μA) max. ✕2 | ESR (mΩ) max. 100k to 300kHz / 20°C | Rated Ripple Current (mA rms) 100kHz / 105°C | D.F. (tan δ) max 120Hz / 20°C |
|----------------------|----------|----------|------------------------------|-------------------------------------|--|-------------------------------|
| 16 (18.4) | 82 | 6.3x6 | 300 | 30 | 2,200 | 0.12 |
| | 100 | 6.3x6 | 320 | 30 | 2,200 | 0.12 |
| | 220 | 6.3x9 | 704 | 15 | 3,500 | 0.12 |
| | 270 | 6.3x9 | 864 | 15 | 3,500 | 0.12 |
| | 330 | 6.3x11 | 1,056 | 15 | 3,500 | 0.12 |
| | 470 | 8x8 | 1,504 | 13 | 4,500 | 0.12 |
| | 470 | 8x12 | 1,504 | 13 | 5,400 | 0.12 |
| | 470 | 10x12 | 1,504 | 13 | 6,100 | 0.12 |
| | 560 | 8x12 | 1,792 | 16 | 5,400 | 0.12 |
| | 680 | 10x12 | 2,176 | 16 | 6,100 | 0.12 |
| | 820 | 10x12 | 2,624 | 10 | 6,100 | 0.12 |
| | 1000 | 8x16 | 3,200 | 10 | 6,100 | 0.12 |
| | 1000 | 10x12 | 3,200 | 10 | 6,100 | 0.12 |
| | 1500 | 8x20 | 4,800 | 8 | 6,100 | 0.12 |
| | 1500 | 10x16 | 4,800 | 8 | 6,500 | 0.12 |
| | 1800 | 10x20 | 5,760 | 8 | 6,800 | 0.12 |
| 2200 | 10x20 | 7,040 | 8 | 6,800 | 0.12 | |
| 20 (23) | 22 | 6.3x6 | 300 | 60 | 1,450 | 0.12 |
| | 82 | 6.3x6 | 328 | 60 | 1,450 | 0.12 |
| | 220 | 6.3x9 | 880 | 40 | 1,620 | 0.12 |
| | 330 | 8x8 | 1,320 | 40 | 2,400 | 0.12 |
| | 470 | 8x12 | 1,880 | 24 | 3,320 | 0.12 |
| | 820 | 10x12 | 3,280 | 20 | 3,800 | 0.12 |
| 25 (28.8) | 6.8 | 6.3x6 | 300 | 80 | 1,200 | 0.12 |
| | 47 | 6.3x6 | 300 | 40 | 2,000 | 0.12 |
| | 100 | 6.3x9 | 500 | 30 | 2,150 | 0.12 |
| | 180 | 8x8 | 900 | 30 | 2,580 | 0.12 |
| | 220 | 8x12 | 1,100 | 25 | 3,200 | 0.12 |
| | 330 | 10x10 | 1,650 | 28 | 3,800 | 0.12 |
| | 470 | 10x12 | 2,350 | 25 | 4,100 | 0.12 |
| | 560 | 10x14 | 2,800 | 16 | 4,500 | 0.12 |
| | 680 | 8x16 | 3,400 | 16 | 4,600 | 0.12 |
| | 820 | 10x14 | 4,100 | 16 | 5,000 | 0.12 |
| 35 (40.3) | 22 | 6.3x6 | 300 | 70 | 1,450 | 0.12 |
| | 68 | 6.3x9 | 476 | 40 | 1,500 | 0.12 |
| | 82 | 8x7 | 574 | 60 | 1,800 | 0.12 |
| | 100 | 8x8 | 700 | 30 | 2,100 | 0.12 |
| | 100 | 8x12 | 700 | 26 | 2,300 | 0.12 |
| | 100 | 10x12 | 700 | 24 | 3,000 | 0.12 |
| | 150 | 8x8 | 1,050 | 30 | 2,500 | 0.12 |
| | 180 | 8x12 | 1,260 | 26 | 2,800 | 0.12 |
| | 220 | 10x10 | 1,540 | 26 | 3,000 | 0.12 |
| | 220 | 10x12 | 1,540 | 24 | 3,200 | 0.12 |
| | 330 | 10x12 | 2,310 | 24 | 3,600 | 0.12 |
| | 470 | 10x16 | 3,290 | 20 | 5,000 | 0.12 |

| Rated Voltage (S.V.) | Cap (μF) | Size DxL | Leakage current (μA) max. ※2 | ESR (mΩ) max. 100k to 300kHz / 20°C | Rated Ripple Current (mA rms) 100kHz / 105°C | D.F. (tan δ) max 120Hz / 20°C |
|----------------------|----------|----------|------------------------------|-------------------------------------|--|-------------------------------|
| 0 (57.5) | 12 | 6.3x9 | 300 | 60 | 1,500 | 0.12 |
| | 33 | 6.3x9 | 330 | 60 | 1,500 | 0.12 |
| | 33 | 8x7 | 330 | 60 | 1,500 | 0.12 |
| | 47 | 8x8 | 470 | 32 | 1,850 | 0.12 |
| | 68 | 8x12 | 680 | 30 | 2,250 | 0.12 |
| | 47 | 8x12 | 470 | 30 | 2,250 | 0.12 |
| | 100 | 10x12 | 1,000 | 28 | 2,560 | 0.12 |
| | 150 | 10x12 | 1,500 | 28 | 2,620 | 0.12 |
| 63 (72.5) | 22 | 6.3x9 | 300 | 60 | 1,500 | 0.12 |
| | 33 | 8x8 | 415 | 32 | 2,050 | 0.12 |
| | 33 | 10x10 | 415 | 32 | 2,200 | 0.12 |
| | 47 | 8x12 | 592 | 26 | 2,200 | 0.12 |
| | 56 | 10x10 | 705 | 30 | 2,300 | 0.12 |
| | 82 | 10x12 | 1,033 | 26 | 2,350 | 0.12 |
| | 100 | 10x12 | 1,260 | 25 | 2,550 | 0.12 |

※ 1. Capacitance tolerance: ±20%(M)

※ 2. After 2 minutes

PSA Series

- Standard SMD type
- Rated voltage: 2.5~25V
- Endurance: 2,000 hours at 105°C
- Applications: motherboards, server, VGA. etc.
- RoHS Compliant.
- Halogen Free compliant

Specifications

| Items | Conditions | Characteristics |
|---|---|---|
| Category Temperature Range | - | -55 to +105°C |
| Rated Voltage Range | - | 2.5 ~ 25V |
| Capacitance Tolerance | at 20°C, 120Hz | ±20% (M) |
| Surge Voltage | at 105°C | Rated voltage x1.15V |
| Leakage Current | at 20°C after 2 minutes | $I \leq 0.2CV$ or $300(\mu A)$ Whichever is greater measured, after 2minutes application of rated working voltage at +20°C. Please see the attached characteristics list |
| Dissipation Factor (tan δ) | at 20°C, 120Hz | Please see the attached characteristics list |
| Characteristics of Impedance at low, high temperature | at -55°C, 100KHz | $Z(-55^\circ C)/Z(+20^\circ C) \leq 1.25$ |
| | at -25°C,100KHz | $Z(-25^\circ C)/Z(+20^\circ C) \leq 1.15$ |
| Endurance | The following specifications shall be satisfied when the capacitors are restored to 20°C after the rated voltage is applied for 2,000 hours at 105°C. | Appearance NO significant damage. |
| | | Capacitance change $\leq \pm 20\%$ of the initial value. |
| | | DF (tan δ) $\leq 150\%$ of the initial specified value. |
| | | ESR $\leq 150\%$ of the initial specified value. |
| | | Leakage current \leq The initial specified value. |
| Damp Heag (Steady State) | The following specifications shall be satisfied when the capacitors are restored to 20°C after subjecting them to store 60°C, 90 to 95% RH for 1,000 hours, without DC applied. | Appearance NO significant damage. |
| | | Capacitance change $\leq \pm 20\%$ of the initial value. |
| | | DF (tan δ) $\leq 150\%$ of the initial specified value. |
| | | ESR $\leq 150\%$ of the initial specified value. |
| | | Leakage current \leq The initial specified value. |
| Surge Voltage | The capacitors shall be subjected to 1,000 cycles each consisting of charge with the surge voltages specified at 105°C for 30 seconds through a protective resistor ($R = 1 \text{ k}\Omega$) and discharge for 5 minutes 30 seconds. | Appearance NO significant damage. |
| | | Capacitance change $\leq \pm 20\%$ of the initial value. |
| | | DF (tan δ) $\leq 150\%$ of the initial specified value. |
| | | ESR $\leq 150\%$ of the initial specified value. |
| | | Leakage current \leq The initial specified value. |

※ Note : If any doubt arises, measure the leakage current after following voltage treatment.
Voltage treatment : DC rated voltage are applied to the capacitors for 120 minutes at 105°C.

Frequency Coefficient for Ripple Current

| Frequency | 120Hz $\leq f < 1$ KHz | 1KHz $\leq f < 10$ KHz | 10KHz $\leq f < 100$ KHz | 100KHz $\leq f < 500$ KHz |
|-------------|------------------------|------------------------|--------------------------|---------------------------|
| Coefficient | 0.05 | 0.3 | 0.7 | 1.0 |

Dimensions

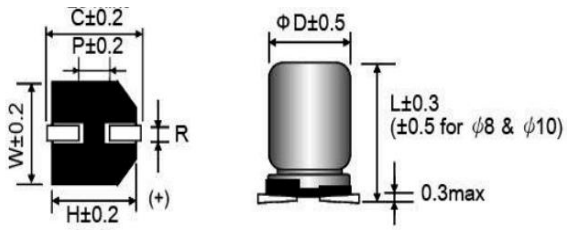

(UNIT: mm)

| ΦDxL | ΦD | L | W | H | C | R | P |
|---------|------|------|------|------|------|---------|-----|
| 5x6 | 5.0 | 6.0 | 5.3 | 5.3 | 6.0 | 0.5~0.8 | 1.4 |
| 6.3x6 | 6.3 | 6.0 | 6.6 | 6.6 | 7.3 | 0.5~0.8 | 2.1 |
| 6.3x7 | 6.3 | 7.0 | 6.6 | 6.6 | 7.3 | 0.5~0.8 | 2.1 |
| 6.3x9.5 | 6.3 | 9.5 | 6.6 | 6.6 | 7.3 | 0.5~0.8 | 2.1 |
| 8x7 | 8.0 | 7.0 | 8.3 | 8.3 | 9.0 | 0.5~0.8 | 3.2 |
| 8x9.5 | 8.0 | 9.5 | 8.3 | 8.3 | 9.0 | 0.8~1.1 | 3.2 |
| 8x12 | 8.0 | 12.0 | 8.3 | 8.3 | 9.0 | 0.8~1.1 | 3.2 |
| 10x10.5 | 10.0 | 10.5 | 10.3 | 10.3 | 11.0 | 0.8~1.1 | 4.6 |
| 10x12.5 | 10.0 | 12.5 | 10.3 | 10.3 | 11.0 | 0.8~1.1 | 4.6 |

PSA SERIES STANDARD CHARACTERISTICS LIST

| Rated Voltage (S.V.) | Cap (μF) | Size DxL | Leakage current (μA) max. ※2 | ESR (mΩ) max. 100k to 300 KHz / 20°C | Rated Ripple Current (mA rms) 100 KHz / 105°C | D.F. (tanδ) max. 120 Hz / 20°C |
|----------------------|----------|----------|------------------------------|--------------------------------------|---|--------------------------------|
| 2.5 (2.9) | 220 | 6.3×6 | 300 | 25 | 2,390 | 0.12 |
| | 330 | 6.3×6 | 300 | 25 | 2,390 | 0.12 |
| | 560 | 6.3×7 | 300 | 25 | 2,390 | 0.12 |
| | 820 | 6.3×9.5 | 410 | 20 | 3,000 | 0.12 |
| | 1,200 | 8×9.5 | 600 | 20 | 4,520 | 0.12 |
| | 1,500 | 8×9.5 | 750 | 20 | 4,520 | 0.12 |
| | 1,800 | 8×12 | 900 | 13 | 4,520 | 0.12 |
| | 2,200 | 10×10.5 | 1,100 | 18 | 4,520 | 0.12 |
| 4 (6.6) | 2,700 | 10×12.5 | 1,350 | 15 | 5,200 | 0.12 |
| | 220 | 6.3×6 | 300 | 25 | 2,000 | 0.12 |
| | 560 | 6.3×9.5 | 448 | 20 | 4,500 | 0.12 |
| | 820 | 8×9.5 | 656 | 20 | 4,500 | 0.12 |
| | 1,000 | 8×9.5 | 800 | 20 | 4,500 | 0.12 |
| | 1,200 | 8×12 | 960 | 15 | 4,820 | 0.12 |
| | 1,500 | 10×10 | 1,200 | 15 | 4,820 | 0.12 |
| | 2,200 | 10×12.5 | 1,760 | 15 | 5,200 | 0.12 |
| 6.3 (7.2) | 100 | 6.3×6 | 300 | 25 | 2,400 | 0.12 |
| | 220 | 6.3×6 | 300 | 25 | 2,400 | 0.12 |
| | 220 | 8×7 | 300 | 25 | 3,020 | 0.12 |
| | 560 | 6.3×9.5 | 705 | 20 | 3,020 | 0.12 |
| | 820 | 8×9.5 | 1,033 | 20 | 4,500 | 0.12 |
| | 1,000 | 8×9.5 | 1,260 | 20 | 4,500 | 0.12 |
| | 1,200 | 8×12 | 1,512 | 15 | 4,800 | 0.12 |
| | 1,500 | 10×10.5 | 1,890 | 15 | 4,950 | 0.12 |
| | 2,200 | 10×12.5 | 2,772 | 15 | 5,200 | 0.12 |
| 10 (11.5) | 33 | 5×6 | 300 | 45 | 1,100 | 0.12 |
| | 100 | 6.3×6 | 300 | 30 | 1,700 | 0.12 |
| | 150 | 6.3×6 | 300 | 45 | 1,700 | 0.12 |
| | 330 | 6.3×9.5 | 660 | 45 | 2,050 | 0.12 |
| | 560 | 8×9.5 | 1,120 | 35 | 2,560 | 0.12 |
| | 680 | 8×9.5 | 1,360 | 35 | 2,560 | 0.12 |
| | 820 | 8×12.5 | 1,640 | 17 | 3,950 | 0.12 |
| | 1,000 | 10×10.5 | 2,000 | 15 | 3,950 | 0.12 |
| | 1,500 | 10×12.5 | 3,000 | 13 | 5,230 | 0.12 |
| 16 (18.4) | 22 | 5×6 | 300 | 40 | 1,000 | 0.12 |
| | 100 | 6.3×6 | 320 | 35 | 1,620 | 0.12 |
| | 270 | 6.3×9.5 | 864 | 20 | 2,500 | 0.12 |
| | 270 | 8×9.5 | 864 | 20 | 3,200 | 0.12 |
| | 330 | 8×9.5 | 1,056 | 20 | 3,690 | 0.12 |
| | 470 | 8×9.5 | 1,504 | 20 | 3,890 | 0.12 |
| | 560 | 8×12 | 1,792 | 20 | 3,940 | 0.12 |
| | 680 | 10×10.5 | 2,176 | 20 | 4,220 | 0.12 |
| | 820 | 10×12.5 | 2,624 | 16 | 4,720 | 0.12 |
| 1,000 | 10×12.5 | 3,200 | 16 | 5,200 | 0.12 | |
| 20 (23.0) | 68 | 6.3×6 | 300 | 38 | 1,450 | 0.12 |
| | 180 | 6.3×9.5 | 720 | 30 | 2,450 | 0.12 |
| | 330 | 8×9.5 | 1,320 | 30 | 3,000 | 0.12 |
| | 470 | 8×12 | 1,880 | 28 | 3,320 | 0.12 |
| | 560 | 10×10.5 | 2,240 | 28 | 3,320 | 0.12 |
| 680 | 10×12.5 | 2,720 | 28 | 4,220 | 0.12 | |

※※ 1. Capacitance tolerance : ±20% (M)

※※ 2. After 2 minutes

PSA SERIES STANDARD CHARACTERISTICS LIST

| Rated Voltage (S.V.) | Cap (μ F) | Size DxL | Leakage current (μ A) max. ※2 | ESR (m Ω) max. 100k to 300 KHz / 20°C | Rated Ripple Current (mA rms) 100 KHz / | D.F. (tan δ) max. 120 Hz / |
|-------------------------|-------------------|-------------|---------------------------------------|---|---|--|
| 25 (28.8) | 47 | 6.3x6 | 300 | 40 | 1,200 | 0.12 |
| | 100 | 6.3x9.5 | 500 | 30 | 2,000 | 0.12 |
| | 100 | 8x7 | 500 | 40 | 2,000 | 0.12 |
| | 150 | 8x9.5 | 750 | 35 | 3,000 | 0.12 |
| | 220 | 8x12 | 1,100 | 28 | 3,500 | 0.12 |
| | 330 | 10x10.5 | 1,650 | 30 | 3,800 | 0.12 |
| | 470 | 10x12.5 | 2,350 | 28 | 4,000 | 0.12 |

※※1. Capacitance tolerance : \pm 20% (M)

※※2. After 2 minutes

PSB Series

- Super low ESR, High ripple current capability
- Rated voltage: 2.5~16V
- Endurance: 2,000hours at 105°C
- Applications: motherboards, servers, VGA, etc.
- RoHS compliant
- Halogen Free compliant

Specifications

| Items | Conditions | Characteristics | |
|---|--|--|--|
| Category Temperature Range | - | -55 to +105°C | |
| Rated Voltage Range | - | 2.5 ~ 16V | |
| Capacitance Tolerance | at 20°C, 120 Hz | ±20% (M) | |
| Surge Voltage | at 105°C | Rated voltage x1.15V | |
| Leakage Current | at 20°C after 2 minutes | $I \leq 0.2CV$ or $300(\mu A)$ Whichever is greater measured, after 2minutes application of rated working voltage at 20°C. Please see the attached characteristics list | |
| Dissipation Factor (tan δ) | at 20°C, 120 Hz | Please see the attached characteristics list | |
| Characteristics of Impedance at low, high temperature | at -55°C,100 KHz | $Z(-55^\circ C) / Z(+20^\circ C) \leq 1.25$ | |
| | at -25°C,100 KHz | $Z(-25^\circ C)/Z(+20^\circ C) \leq 1.15$ | |
| Endurance | The following specifications shall be satisfied when the capacitors are restored to 20°C after the rated voltage is applied for 2,000 hours at 105°C. | Appearance | NO significant damage. |
| | | Capacitance change | $\leq \pm 20\%$ of the initial value. |
| | | DF (tan δ) | $\leq 150\%$ of the initial specified value. |
| | | ESR | $\leq 150\%$ of the initial specified value. |
| | | Leakage current | \leq The initial specified value. |
| Damp Heag (Steady State) | The following specifications shall be satisfied when the capacitors are restored to 20°C after subjecting them to store 60°C, 90 to 95% RH for 1,000 hours, without DC applied. | Appearance | NO significant damage. |
| | | Capacitance change | $\leq \pm 20\%$ of the initial value. |
| | | DF (tan δ) | $\leq 150\%$ of the initial specified value. |
| | | ESR | $\leq 150\%$ of the initial specified value. |
| | | Leakage current | \leq The initial specified value. |
| Surge Voltage | The capacitors shall be subjected to 1,000 cycles each consisting of charge with the surge voltages specified at 105°C for 30 seconds through a protective resistor (R = 1 kΩ) and discharge for 5 minutes 30 seconds. | Appearance | No significant damage. |
| | | Capacitance change | $\leq \pm 20\%$ of the initial value. |
| | | DF (tan δ) | $\leq 150\%$ of the initial specified value. |
| | | ESR | $\leq 150\%$ of the initial specified value. |
| | | Leakage current | \leq The initial specified value. |

※ Note : If any doubt arises, measure the leakage current after following voltage treatment.
Voltage treatment : DC rated voltage are applied to the capacitors for 120 minutes at 105°C.

Frequency Coefficient for Ripple Current

| Frequency (Hz) | $120\text{Hz} \leq f < 1\text{KHz}$ | $1\text{KHz} \leq f < 10\text{KHz}$ | $10\text{KHz} \leq f < 100\text{KHz}$ | $100\text{KHz} \leq f < 500\text{KHz}$ |
|----------------|-------------------------------------|-------------------------------------|---------------------------------------|--|
| Coefficient | 0.05 | 0.3 | 0.7 | 1 |

Marking & Dimensions

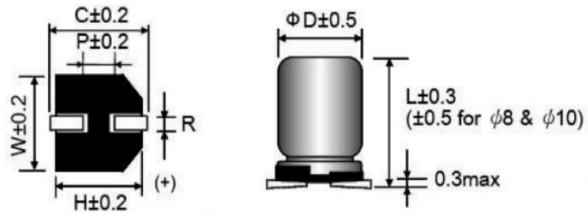

(UNIT: mm)

| $\Phi D \times L$ | ΦD | L | W | H | C | R | P |
|-------------------|----------|------|------|------|------|---------|-----|
| 5x6 | 5.0 | 6.0 | 5.3 | 5.3 | 6.0 | 0.5~0.8 | 1.4 |
| 6.3x6 | 6.3 | 6.0 | 6.6 | 6.6 | 7.3 | 0.5~0.8 | 2.1 |
| 6.3x9.5 | 6.3 | 9.5 | 6.6 | 6.6 | 7.3 | 0.5~0.8 | 2.1 |
| 8x7 | 8.0 | 7.0 | 8.3 | 8.3 | 9.0 | 0.5~0.8 | 3.2 |
| 8x9.5 | 8.0 | 9.5 | 8.3 | 8.3 | 9.0 | 0.8~1.1 | 3.2 |
| 8x12 | 8.0 | 12.0 | 8.3 | 8.3 | 9.0 | 0.8~1.1 | 3.2 |
| 10x10.5 | 10.0 | 10.5 | 10.3 | 10.3 | 11.0 | 0.8~1.1 | 4.6 |
| 10x12.5 | 10.0 | 12.5 | 10.3 | 10.3 | 11.0 | 0.8~1.1 | 4.6 |

PSB SERIES STANDARD CHARACTERISTICS LIST

| Rated Voltage (S.V.) | Cap (μ F) | Size DxL | Leakage current (μ A) max. ※2 | ESR (m Ω) max. 100k to 300 KHz / 20°C | Rated Ripple Current (mA rms) 100 KHz / 105°C | D.F. (tan δ) max. 120 Hz / 20°C |
|-------------------------|-------------------|-------------|---------------------------------------|---|---|---|
| 2.5 (2.9) | 220 | 5x6 | 300 | 40 | 1,620 | 0.12 |
| | 330 | 6.3x6 | 300 | 20 | 2,690 | 0.12 |
| | 820 | 6.3x9.5 | 410 | 18 | 3,200 | 0.12 |
| | 820 | 8x9.5 | 410 | 18 | 4,520 | 0.12 |
| | 1,500 | 8x9.5 | 750 | 18 | 4,520 | 0.12 |
| | 1,800 | 8x12 | 900 | 12 | 5,200 | 0.12 |
| | 2,700 | 10x12.5 | 1,350 | 12 | 5,500 | 0.12 |
| 4 (4.6) | 68 | 5x6 | 300 | 40 | 1,500 | 0.12 |
| | 150 | 6.3x6 | 300 | 24 | 2,200 | 0.12 |
| | 680 | 6.3x9.5 | 544 | 16 | 3,200 | 0.12 |
| | 680 | 8x7 | 544 | 20 | 3,400 | 0.12 |
| | 1,000 | 8x9.5 | 800 | 16 | 4,500 | 0.12 |
| | 1,500 | 8x12 | 1,200 | 14 | 5,100 | 0.12 |
| | 1,800 | 10x12.5 | 1,440 | 12 | 5,500 | 0.12 |
| 6.3 (7.2) | 2,200 | 10x12.5 | 2,000 | 12 | 5,500 | 0.12 |
| | 100 | 5x6 | 300 | 40 | 1,500 | 0.12 |
| | 220 | 5x7 | 300 | 20 | 1,600 | 0.12 |
| | 220 | 6.3x6 | 300 | 20 | 2,400 | 0.12 |
| | 560 | 6.3x9.5 | 705 | 20 | 3,200 | 0.12 |
| | 560 | 8x7 | 705 | 20 | 3,300 | 0.12 |
| | 820 | 8x9.5 | 1,033 | 15 | 4,450 | 0.12 |
| | 1,000 | 8x9.5 | 1,260 | 15 | 4,520 | 0.12 |
| | 1,200 | 8x12 | 1,512 | 12 | 5,020 | 0.12 |
| | 1,500 | 10x10 | 1,890 | 15 | 5,020 | 0.12 |
| 10 (11.5) | 1,800 | 10x12.5 | 2,268 | 12 | 5,400 | 0.12 |
| | 2,200 | 10x12.5 | 2,772 | 12 | 5,500 | 0.12 |
| | 68 | 5x6 | 300 | 40 | 1,500 | 0.12 |
| | 120 | 6.3x6 | 300 | 25 | 2,420 | 0.12 |
| | 150 | 8x7 | 300 | 22 | 2,450 | 0.12 |
| | 330 | 6.3x9.5 | 660 | 20 | 3,200 | 0.12 |
| | 560 | 8x9.5 | 1,120 | 16 | 4,450 | 0.12 |
| | 680 | 8x9.5 | 1,360 | 16 | 4,450 | 0.12 |
| | 820 | 8x12 | 1,640 | 14 | 4,850 | 0.12 |
| | 1,000 | 10x10 | 2,000 | 15 | 5,020 | 0.12 |
| 16 (18.4) | 1,200 | 10x10 | 2,400 | 15 | 5,200 | 0.12 |
| | 1,500 | 10x12.5 | 3,000 | 14 | 5,400 | 0.12 |
| | 100 | 6.3x6 | 320 | 24 | 2,400 | 0.12 |
| | 180 | 6.3x9.5 | 576 | 20 | 3,200 | 0.12 |
| | 220 | 6.3x9.5 | 704 | 20 | 3,200 | 0.12 |
| | 270 | 6.3x9.5 | 864 | 20 | 3,200 | 0.12 |
| | 270 | 8x7 | 864 | 20 | 3,400 | 0.12 |
| | 270 | 8x9.5 | 864 | 20 | 4,400 | 0.12 |
| | 470 | 8x9.5 | 1,504 | 20 | 4,400 | 0.12 |
| | 560 | 8x12 | 1,792 | 16 | 4,820 | 0.12 |
| 16 (18.4) | 680 | 10x10 | 2,176 | 18 | 5,200 | 0.12 |
| | 1,000 | 10x12.5 | 3,200 | 16 | 5,400 | 0.12 |

※※ 1. Capacitance tolerance : \pm 20% (M)

※※ 2. After 2 minutes

PSC Series

- Super low ESR, Long Life capability
- Rated voltage: 4~50V.
- Endurance: 5,000hours at 105°C
- Applications: DC/DC Converter, Voltage Regulators, Decoupling
- Applications for Computer Motherboards, etc.
- RoHS Compliant.
- Halogen Free compliant

Specifications

| Items | Conditions | Characteristics | |
|---|---|---|--|
| Category Temperature Range | - | -55 to +105°C | |
| Rated Voltage Range | - | 4~50V | |
| Capacitance Tolerance | at 20°C, 120Hz | ±20% (M) | |
| Surge Voltage | at 105°C | Rated voltage x1.15V | |
| Leakage Current | at 20°C after 2 minutes | $I \leq 0.2CV$ or $300(\mu A)$ Whichever is greater measured, after 2minutes application of rated Working voltage at +20°C. Please see the attached characteristics list | |
| Dissipation Factor (tan δ) | at 20°C, 120Hz | Please see the attached characteristics list | |
| Characteristics of Impedance at low, high temperature | at -55°C, 100KHz | $Z(-55^\circ C) / Z(+20^\circ C) \leq 1.25$ | |
| | at -25°C, 100KHz | $Z(-25^\circ C) / Z(+20^\circ C) \leq 1.15$ | |
| Endurance | The following specifications shall be satisfied when the capacitors are restored to 20°C after the rated voltage is applied for 5,000 hours at 105°C. | Appearance | NO significant damage. |
| | | Capacitance change | $\leq \pm 20\%$ of the initial value. |
| | | DF (tan δ) | $\leq 150\%$ of the initial specified value. |
| | | ESR | $\leq 150\%$ of the initial specified value. |
| Damp Heag (Steady State) | The following specifications shall be satisfied when the capacitors are restored to 20°C after subjecting them to store 60°C, 90 to 95% RH for 1,000 hours, without DC applied. | Appearance | NO significant damage. |
| | | Capacitance change | $\leq \pm 20\%$ of the initial value. |
| | | DF (tan δ) | $\leq 150\%$ of the initial specified value. ESR |
| | | ESR | $\leq 150\%$ of the initial specified value. |
| Surge Voltage | The capacitors shall be subjected to 1,000 cycles each consisting of charge with the surge voltages specified at 105°C for 30 seconds through a protective resistor (R = 1kΩ) and discharge for 5 minutes 30 seconds. | Appearance | NO significant damage. |
| | | Capacitance change | $\leq \pm 20\%$ of the initial |
| | | DF (tan δ) | $\leq 150\%$ of the initial specified value. |
| | | ESR | $\leq 150\%$ of the initial specified value. |
| | | Leakage current | \leq The initial specified value. |

※ Note : If any doubt arises, measure the leakage current after following voltage treatment.
Voltage treatment : DC rated voltage are applied to the capacitors for 120 minutes at 105°C.

Frequency Coefficient for Ripple Current

| Frequency (Hz) | $120\text{Hz} \leq f < 1\text{KHz}$ | $1\text{KHz} \leq f < 10\text{KHz}$ | $10\text{KHz} \leq f < 100\text{KHz}$ | $100\text{KHz} \leq f < 500\text{KHz}$ |
|----------------|-------------------------------------|-------------------------------------|---------------------------------------|--|
| Coefficient | 0.05 | 0.3 | 0.7 | 1 |

Marking & Dimensions

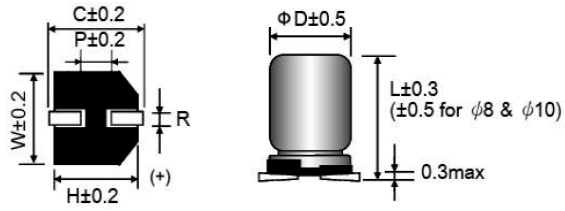

(UNIT: mm)

| ΦDxL | ΦD | L | W | H | C | R | P |
|---------|------|------|------|------|------|---------|-----|
| 6.3x6 | 6.3 | 6.0 | 6.6 | 6.6 | 7.3 | 0.5~0.8 | 2.1 |
| 6.3x7 | 6.3 | 7.0 | 6.6 | 6.6 | 7.3 | 0.5~0.8 | 2.1 |
| 6.3x9.5 | 6.3 | 9.5 | 6.6 | 6.6 | 7.3 | 0.5~0.8 | 2.1 |
| 8x7 | 8.0 | 7.0 | 8.3 | 8.3 | 9.3 | 0.5~0.8 | 3.2 |
| 8x9.5 | 8.0 | 9.5 | 8.3 | 8.3 | 9.3 | 0.8~1.1 | 3.2 |
| 8x12 | 8.0 | 12.0 | 8.3 | 8.3 | 9.0 | 0.8~1.1 | 3.2 |
| 10x10.5 | 10.0 | 10.5 | 10.3 | 10.3 | 11.0 | 0.8~1.1 | 4.6 |
| 10x12.5 | 10.0 | 12.5 | 10.3 | 10.3 | 11.0 | 0.8~1.1 | 4.6 |

PSC SERIES STANDARD CHARACTERISTICS LIST

| Rated Voltage (S.V.) | Cap (μ F) | Size DxL | Leakage current (μ A) max. ※2 | ESR (m Ω) max. 100k to 300KHz / 20°C | Rated Ripple Current (mA rms) 100KHz / 105°C | D.F. (tan δ) max. 120 Hz / 20°C |
|-------------------------|-------------------|-------------|---------------------------------------|--|--|---|
| 4 (4.6) | 220 | 6.3X6 | 300 | 20 | 2,800 | 0.12 |
| | 560 | 6.3x9.5 | 448 | 20 | 3,500 | 0.12 |
| | 560 | 8x7 | 448 | 18 | 3,700 | 0.12 |
| | 820 | 8x9.5 | 656 | 15 | 4,000 | 0.12 |
| | 1,200 | 8x12 | 960 | 15 | 4,450 | 0.12 |
| | 1,500 | 10x10.5 | 1,200 | 13 | 4,500 | 0.12 |
| | 2,200 | 10x12.5 | 1,760 | 13 | 5,400 | 0.12 |
| 6.3 (7.3) | 100 | 6.3x6 | 300 | 22 | 2,400 | 0.12 |
| | 220 | 6.3x6 | 300 | 22 | 2,600 | 0.12 |
| | 470 | 6.3x9.5 | 592 | 22 | 3,200 | 0.12 |
| | 560 | 6.3x9.5 | 705 | 22 | 3,200 | 0.12 |
| | 820 | 8x9.5 | 1,033 | 20 | 3,850 | 0.12 |
| | 1,000 | 8x12 | 1,260 | 20 | 4,250 | 0.12 |
| | 1,200 | 10x10.5 | 1,512 | 18 | 4,350 | 0.12 |
| | 1,800 | 10x12.5 | 2,268 | 18 | 5,200 | 0.12 |
| 10 (11.5) | 68 | 6.3x6 | 300 | 30 | 2,400 | 0.12 |
| | 100 | 6.3x6 | 300 | 30 | 2,400 | 0.12 |
| | 220 | 6.3x7 | 440 | 30 | 2,500 | 0.12 |
| | 330 | 6.3x9.5 | 660 | 30 | 3,150 | 0.12 |
| | 560 | 8x9.5 | 1,120 | 25 | 3,850 | 0.12 |
| | 680 | 8x12 | 1,360 | 25 | 4,150 | 0.12 |
| | 820 | 10x10.5 | 1,640 | 20 | 4,250 | 0.12 |
| | 1,000 | 10x10.5 | 2,000 | 20 | 4,250 | 0.12 |
| | 1,200 | 10x12.5 | 2,400 | 20 | 5,100 | 0.12 |
| 16 (18.4) | 100 | 6.3x6 | 320 | 30 | 2,200 | 0.12 |
| | 220 | 6.3x9.5 | 704 | 30 | 3,050 | 0.12 |
| | 330 | 8x9.5 | 1,056 | 20 | 3,450 | 0.12 |
| | 470 | 8x12 | 1,504 | 20 | 4,050 | 0.12 |
| | 680 | 10x10.5 | 2,176 | 20 | 4,150 | 0.12 |
| | 820 | 10x12.5 | 2,624 | 20 | 5,100 | 0.12 |
| | 1,200 | 10x12.5 | 3,200 | 20 | 5,100 | 0.12 |
| 25 (28.8) | 47 | 6.3x6 | 300 | 40 | 1,500 | 0.12 |
| | 100 | 6.3x9.5 | 500 | 35 | 2,800 | 0.12 |
| | 180 | 8x9.5 | 900 | 30 | 3,250 | 0.12 |
| | 220 | 8x12 | 1,100 | 30 | 3,900 | 0.12 |
| | 330 | 10x10.5 | 1,650 | 20 | 4,100 | 0.12 |
| | 470 | 10x12.5 | 2,350 | 25 | 4,500 | 0.12 |
| 35 (40.3) | 22 | 6.3x6 | 300 | 70 | 1,450 | 0.12 |
| | 68 | 6.3x9.5 | 476 | 60 | 1,500 | 0.12 |
| | 120 | 8x9.5 | 840 | 50 | 1,800 | 0.12 |
| | 150 | 8x12 | 1,050 | 50 | 2,850 | 0.12 |
| | 220 | 10x10.5 | 1,540 | 40 | 2,950 | 0.12 |
| | 270 | 10x12.5 | 1,890 | 40 | 3,200 | 0.12 |
| 50 (57.5) | 10 | 6.3x6 | 300 | 60 | 1,400 | 0.12 |
| | 33 | 6.3x9.5 | 330 | 30 | 1,700 | 0.12 |
| | 47 | 8x9.5 | 470 | 30 | 2,000 | 0.12 |
| | 68 | 8x12 | 680 | 28 | 2,200 | 0.12 |
| | 100 | 10x10.5 | 1,000 | 30 | 2,300 | 0.12 |
| | 100 | 10x12.5 | 1,000 | 26 | 2,650 | 0.12 |

※※ 1. Capacitance tolerance : \pm 20% (M)

※※ 2. After 2 minutes

PSD Series

- Low ESR, High Voltage, High ripple current capability
- Rated voltage: 35~100V.
- Endurance: 2,000hours at 105°C
- Applications: LED Driver, LED Power Supply, etc.
- RoHS compliant
- Halogen Free compliant

Specifications

| Items | Conditions | Characteristics | |
|---|--|---|--|
| Category Temperature Range | - | -55 to +105°C | |
| Rated Voltage Range | - | 35~100V | |
| Capacitance Tolerance | at 20°C, 120Hz | ±20% (M) | |
| Surge Voltage | at 105°C | Rated voltage x1.15V | |
| Leakage Current | at 20°C after 2 minutes | $I \leq 0.2CV$ or $300(\mu A)$ Whichever is greater measured, after 2minutes application of rated Working voltage at +20°C. Please see the attached characteristics list | |
| Dissipation Factor (tan δ) | at 20°C, 120Hz | Please see the attached characteristics list | |
| Characteristics of Impedance at low, high temperature | at -55°C, 100KHz | $Z(-55^\circ C) / Z(+20^\circ C) \leq 1.25$ | |
| | at -25°C, 100KHz | $Z(-25^\circ C) / Z(+20^\circ C) \leq 1.15$ | |
| Endurance | The following specifications shall be satisfied when the capacitors are restored to 20°C after the rated voltage is applied for 2,000 hours at 105°C. | Appearance | NO significant damage. |
| | | Capacitance change | $\leq \pm 20\%$ of the initial value. |
| | | DF (tan δ) | $\leq 150\%$ of the initial specified value. |
| | | ESR | $\leq 150\%$ of the initial specified value. |
| Damp Heag (Steady State) | The following specifications shall be satisfied when the capacitors are restored to 20°C after subjecting them to store 60°C, 90 to 95% RH for 1,000 hours, without DC applied. | Appearance | NO significant damage. |
| | | Capacitance change | $\leq \pm 20\%$ of the initial value. |
| | | DF (tan δ) | $\leq 150\%$ of the initial specified value. ESR |
| | | ESR | $\leq 150\%$ of the initial specified value. |
| Surge Voltage | The capacitors shall be subjected to 1,000 cycles each consisting of charge with the surge voltages specified at 105°C for 30 seconds through a protective resistor (R = 1 kΩ) and discharge for 5 minutes 30 seconds. | Appearance | NO significant damage. |
| | | Capacitance change | $\leq \pm 20\%$ of the initial |
| | | DF (tan δ) | $\leq 150\%$ of the initial specified value. |
| | | ESR | $\leq 150\%$ of the initial specified value. |
| | | Leakage current | \leq The initial specified value. |

※ Note : If any doubt arises, measure the leakage current after following voltage treatment.
Voltage treatment : DC rated voltage are applied to the capacitors for 120 minutes at 105°C.

Frequency Coefficient for Ripple Current

| Frequency (Hz) | $120\text{Hz} \leq f < 1\text{KHz}$ | $1\text{KHz} \leq f < 10\text{KHz}$ | $10\text{KHz} \leq f < 100\text{KHz}$ | $100\text{KHz} \leq f < 500\text{KHz}$ |
|----------------|-------------------------------------|-------------------------------------|---------------------------------------|--|
| Coefficient | 0.05 | 0.3 | 0.7 | 1 |

Marking & Dimensions

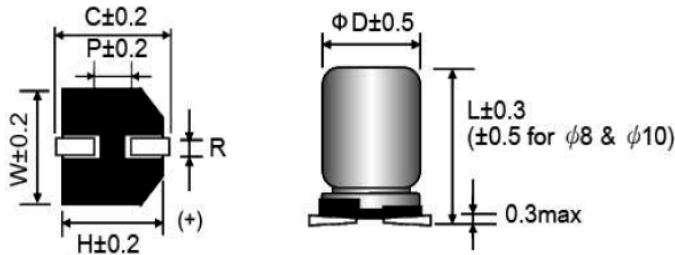

(UNIT: mm)

| ΦDxL | ΦD | L | W | H | C | R | P |
|---------|------|------|------|------|------|---------|-----|
| 6.3x6 | 6.3 | 6.0 | 6.6 | 6.6 | 7.3 | 0.5~0.8 | 2.1 |
| 6.3x9.5 | 6.3 | 9.5 | 6.6 | 6.6 | 7.3 | 0.5~0.8 | 2.1 |
| 8x7 | 8.0 | 7.0 | 8.3 | 8.3 | 9.3 | 0.5~0.8 | 3.2 |
| 8x9.5 | 8.0 | 9.5 | 8.3 | 8.3 | 9.3 | 0.8~1.1 | 3.2 |
| 8x12 | 8.0 | 12.0 | 8.3 | 8.3 | 9.0 | 0.8~1.1 | 3.2 |
| 10x10.5 | 10.0 | 10.5 | 10.3 | 10.3 | 11.0 | 0.8~1.1 | 4.6 |
| 10x12.5 | 10.0 | 12.5 | 10.3 | 10.3 | 11.0 | 0.8~1.1 | 4.6 |

PSD SERIES STANDARD CHARACTERISTICS LIST

| Rated Voltage (S.V.) | Cap (μF) | Size DxL | Leakage current (μA) max. ※2 | ESR (mΩ) max. 100k to 300KHz / 20°C | Rated Ripple Current (mA rms) 100KHz / 105°C | D.F. (tanδ) max. 120Hz / 20°C |
|----------------------|----------|----------|------------------------------|-------------------------------------|--|-------------------------------|
| 35 (40.3) | 22 | 6.3x6 | 300 | 80 | 1,450 | 0.12 |
| | 56 | 6.3x9.5 | 392 | 50 | 2,300 | 0.12 |
| | 68 | 6.3x9.5 | 476 | 50 | 2,300 | 0.12 |
| | 68 | 8x7 | 476 | 60 | 2,500 | 0.12 |
| | 100 | 8x12 | 700 | 28 | 2,750 | 0.12 |
| 50 (57.5) | 220 | 10x12.5 | 1,540 | 28 | 3,200 | 0.12 |
| | 12 | 6.3x6 | 300 | 100 | 1,450 | 0.12 |
| | 33 | 6.3x9.5 | 330 | 50 | 1,800 | 0.12 |
| | 47 | 8x9.5 | 470 | 45 | 2,100 | 0.12 |
| | 100 | 10x12.5 | 1,000 | 28 | 2,560 | 0.12 |
| 63 (72.5) | 180 | 10x12.5 | 1,800 | 28 | 2,750 | 0.12 |
| | 22 | 6.3x9.5 | 300 | 50 | 1,800 | 0.12 |
| | 33 | 6.3x9.5 | 416 | 50 | 1,800 | 0.12 |
| | 47 | 8x12 | 592 | 36 | 2,200 | 0.12 |
| | 56 | 10x10.5 | 705 | 32 | 2,350 | 0.12 |
| 80.0 (92.0) | 100 | 10x12.5 | 1,260 | 28 | 2,550 | 0.12 |
| | 150 | 10x12.5 | 1,890 | 28 | 2,550 | 0.12 |
| | 22 | 8x9.5 | 352 | 45 | 2,100 | 0.12 |
| | 33 | 8x12 | 528 | 45 | 2,100 | 0.12 |
| | 47 | 10x10.5 | 752 | 45 | 2,250 | 0.12 |
| 100 (115.0) | 68 | 10x12.5 | 1,088 | 38 | 2,550 | 0.12 |
| | 15 | 8x12 | 300 | 40 | 2,050 | 0.12 |
| | 22 | 10x12.5 | 440 | 38 | 2,250 | 0.12 |
| | 27 | 10x12.5 | 540 | 38 | 2,250 | 0.12 |

※※ 1. Capacitance tolerance : ±20% (M)

※※ 2. After 2 minutes

PSE Series

- Super low ESR, High ripple current capability
- Rated voltage: 4~50V.
- Endurance: 1,000hours at 125°C
- Applications: Motherboard, DC/DC Converter, Adapter, SPS, VCR, Camcorder, DSC, PDA, HD Drive, MO Drive, etc.
- RoHS compliant
- Halogen Free compliant

Specifications

| Items | Conditions | Characteristics | |
|---|--|---|--|
| Category Temperature Range | - | -55 to +125°C | |
| Rated Voltage Range | - | 4.0~50V | |
| Capacitance Tolerance | at 20°C, 120 Hz | ±20% (M) | |
| Surge Voltage | at 105°C | Rated voltage x1.15V | |
| Leakage Current | at 20°C after 2 minutes | $I \leq 0.2CV$ or $300(\mu A)$ Whichever is greater measured, after 2minutes application of rated Working voltage at +20°C. Please see the attached characteristics list | |
| Dissipation Factor (tan δ) | at 20°C, 120Hz | Please see the attached characteristics list | |
| Characteristics of Impedance at low, high temperature | at -55°C, 100KHz | $Z(-55^\circ C) / Z(+20^\circ C) \leq 1.25$ | |
| | at -25°C, 100KHz | $Z(-25^\circ C) / Z(+20^\circ C) \leq 1.15$ | |
| Endurance | The following specifications shall be satisfied when the capacitors are restored to 20°C after the rated voltage is applied for 1,000 hours at 125°C. | Appearance | NO significant damage. |
| | | Capacitance change | $\leq \pm 20\%$ of the initial value. |
| | | DF (tan δ) | $\leq 150\%$ of the initial specified value. |
| | | ESR | $\leq 150\%$ of the initial specified value. |
| | | Leakage current | \leq The initial specified value. |
| Damp Heat (Steady State) | The following specifications shall be satisfied when the capacitors are restored to 20°C after subjecting them to store 60°C, 90 to 95% RH for 1,000 hours, without DC applied. | Appearance | NO significant damage. |
| | | Capacitance change | $\leq \pm 20\%$ of the initial value. |
| | | DF (tan δ) | $\leq 150\%$ of the initial specified value. ESR |
| | | Leakage current | \leq The initial specified value. |
| Surge Voltage | The capacitors shall be subjected to 1,000 cycles each consisting of charge with the surge voltages specified at 105°C for 30 seconds through a protective resistor (R = 1 kΩ) and discharge for 5 minutes 30 seconds. | Appearance | NO significant damage. |
| | | Capacitance change | $\leq \pm 20\%$ of the initial |
| | | DF (tan δ) | $\leq 150\%$ of the initial specified value. |
| | | ESR | $\leq 150\%$ of the initial specified value. |
| | | Leakage current | \leq The initial specified value. |

※ Note : If any doubt arises, measure the leakage current after following voltage treatment.
Voltage treatment : DC rated voltage are applied to the capacitors for 120 minutes at 125°C.

Frequency Coefficient for Ripple Current

| Frequency (Hz) | $120\text{Hz} \leq f < 1\text{KHz}$ | $1\text{KHz} \leq f < 10\text{KHz}$ | $10\text{KHz} \leq f < 100\text{KHz}$ | $100\text{KHz} \leq f < 500\text{KHz}$ |
|----------------|-------------------------------------|-------------------------------------|---------------------------------------|--|
| Coefficient | 0.05 | 0.3 | 0.7 | 1 |

Marking & Dimensions

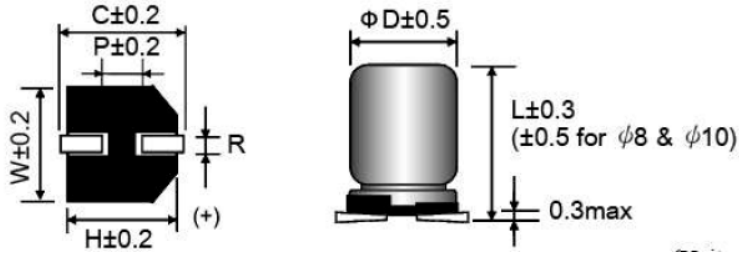

(UNIT: mm)

| $\Phi D \times L$ | ΦD | L | W | H | C | R | P |
|-------------------|----------|------|------|------|------|---------|-----|
| 6.3x6 | 6.3 | 6.0 | 6.6 | 6.6 | 7.3 | 0.5~0.8 | 2.1 |
| 6.3x7 | 6.3 | 7.0 | 6.6 | 6.6 | 7.3 | 0.5~0.8 | 2.1 |
| 6.3x9.5 | 6.3 | 9.5 | 6.6 | 6.6 | 7.3 | 0.5~0.8 | 2.1 |
| 8x7 | 8.0 | 7.0 | 8.3 | 8.3 | 9.0 | 0.5~0.8 | 3.2 |
| 8x9.5 | 8.0 | 9.5 | 8.3 | 8.3 | 9.0 | 0.8~1.1 | 3.2 |
| 8x12 | 8.0 | 12.0 | 8.3 | 8.3 | 9.0 | 0.8~1.1 | 3.2 |
| 10x10.5 | 10.0 | 10.5 | 10.3 | 10.3 | 11.0 | 0.8~1.1 | 4.6 |
| 10x12.5 | 10.0 | 12.5 | 10.3 | 10.3 | 11.0 | 0.8~1.1 | 4.6 |

PSE SERIES STANDARD CHARACTERISTICS LIST

| Rated Voltage (S.V.) | Cap (μ F) | Size DxL | Leakage current (μ A) max. ※2 | ESR (m Ω) max. 100k to 300KHz / 20°C | Rated Ripple Current (mA rms) | | D.F. (tan δ) max. 120Hz / 20°C |
|-------------------------|-------------------|-------------|---------------------------------------|--|----------------------------------|---------------|--|
| | | | | | 105°C 100 kHz | 125°C 100 kHz | |
| 4 (4.6) | 150 | 6.3x6 | 300 | 35 | 2,450 | 700 | 0.12 |
| | 220 | 6.3x6 | 300 | 20 | 2,800 | 800 | 0.12 |
| | 560 | 6.3x9.5 | 448 | 20 | 3,000 | 857 | 0.12 |
| | 560 | 8x7 | 448 | 20 | 3,000 | 857 | 0.12 |
| | 820 | 8x9.5 | 656 | 15 | 3,500 | 1,000 | 0.12 |
| | 1,200 | 8x12 | 960 | 15 | 3,800 | 1,086 | 0.12 |
| | 1,500 | 10x10.5 | 1,200 | 12 | 4,500 | 1,286 | 0.12 |
| 2,200 | 10x12.5 | 1,760 | 12 | 5,500 | 1,571 | 0.12 | |
| 6.3 (7.2) | 100 | 6.3x6 | 300 | 40 | 2,400 | 686 | 0.12 |
| | 150 | 6.3x6 | 300 | 40 | 2,400 | 686 | 0.12 |
| | 330 | 6.3x7 | 415 | 30 | 2,800 | 800 | 0.12 |
| | 470 | 6.3x9.5 | 592 | 25 | 2,800 | 800 | 0.12 |
| | 680 | 8x9.5 | 856 | 25 | 2,800 | 800 | 0.12 |
| | 820 | 8x12 | 1,033 | 20 | 3,000 | 857 | 0.12 |
| | 1,000 | 8x12 | 1,260 | 20 | 3,000 | 857 | 0.12 |
| | 1,200 | 10x10.5 | 1,512 | 20 | 3,000 | 857 | 0.12 |
| 1,800 | 10x12.5 | 2,268 | 18 | 3,000 | 857 | 0.12 | |
| 10 (11.5) | 100 | 6.3x6 | 300 | 35 | 2,800 | 800 | 0.12 |
| | 330 | 6.3x9.5 | 660 | 25 | 2,800 | 800 | 0.12 |
| | 470 | 8x9.5 | 940 | 25 | 3,000 | 857 | 0.12 |
| | 560 | 8x9.5 | 1,120 | 25 | 3,000 | 857 | 0.12 |
| | 680 | 8x12 | 1,360 | 20 | 3,500 | 1,000 | 0.12 |
| | 820 | 10x10 | 1,640 | 20 | 3,500 | 1,000 | 0.12 |
| | 1,000 | 10x10 | 2,000 | 20 | 3,500 | 1,000 | 0.12 |
| | 1,200 | 10x12.5 | 2,400 | 12 | 5,200 | 1,486 | 0.12 |
| 16 (18.4) | 100 | 6.3x6 | 320 | 35 | 2,050 | 586 | 0.12 |
| | 220 | 6.3x9.5 | 704 | 25 | 2,050 | 586 | 0.12 |
| | 330 | 8x9.5 | 1,056 | 25 | 2,700 | 771 | 0.12 |
| | 470 | 8x12 | 1,504 | 20 | 3,930 | 1,123 | 0.12 |
| | 680 | 10x10.5 | 2,176 | 18 | 4,520 | 1,291 | 0.12 |
| | 820 | 10x12.5 | 2,624 | 18 | 4,900 | 1,400 | 0.12 |
| 25 (28.8) | 47 | 6.3x6 | 300 | 60 | 1,650 | 471 | 0.12 |
| | 100 | 6.3x9.5 | 500 | 30 | 1,650 | 471 | 0.12 |
| | 220 | 8x12 | 1,100 | 28 | 3,310 | 946 | 0.12 |
| | 330 | 10x10.5 | 1,650 | 30 | 4,320 | 1,234 | 0.12 |
| | 470 | 10x12.5 | 2,350 | 28 | 4,500 | 1,286 | 0.12 |
| 35 (40.3) | 22 | 6.3x6 | 300 | 70 | 1,450 | 414 | 0.12 |
| | 68 | 6.3x9.5 | 476 | 40 | 1,450 | 414 | 0.12 |
| | 120 | 8x9.5 | 840 | 40 | 1,800 | 514 | 0.12 |
| | 150 | 8x12 | 1,050 | 30 | 2,000 | 571 | 0.12 |
| | 220 | 10x10.5 | 1,540 | 30 | 2,200 | 629 | 0.12 |
| | 270 | 10x12.5 | 1,890 | 30 | 2,500 | 714 | 0.12 |
| 50 (57.5) | 10 | 6.3x6 | 300 | 60 | 1,400 | 400 | 0.12 |
| | 33 | 6.3x9.5 | 330 | 40 | 1,500 | 429 | 0.12 |
| | 47 | 8x9.5 | 470 | 40 | 2,000 | 571 | 0.12 |
| | 68 | 8x12 | 680 | 35 | 2,300 | 657 | 0.12 |
| | 100 | 10x10.5 | 1,000 | 35 | 2,200 | 629 | 0.12 |
| | 100 | 10x12.5 | 1,000 | 35 | 2,500 | 714 | 0.12 |

※※ 1. Capacitance tolerance : \pm 20% (M)

※※ 2. After 2 minutes

PSF Series

- High temperature Low ESR, High ripple current capability
- Rated voltage: 6.3~35V
- Endurance: 2,000 hours at 125°C
- Applications: Lamps Power, LED Driver, Service Equipment.
- RoHS compliance
- Halogen Free compliant

Specifications

| Items | Conditions | Characteristics |
|---|--|--|
| Category Temperature Range | - | -55 to +125°C |
| Rated Voltage Range | - | 6.3~35V |
| Capacitance Tolerance | at 20°C, 120Hz | ±20% (M) |
| Surge Voltage | at 125°C | Rated voltage x1.15V |
| Leakage Current | at 20°C after 2 minutes | $I \leq 0.2CV$ or 300(μA) Whichever is greater measured, after 2minutes application of rated Working voltage at +20°C. Please see the attached characteristics list |
| Dissipation Factor (tan δ) | at 20°C, 120Hz | Please see the attached characteristics list |
| Characteristics of Impedance at low, high temperature | at -55°C, 100KHz | $Z(-55^\circ\text{C}) / Z(+20^\circ\text{C}) \leq 1.25$ |
| | at -25°C, 100KHz | $Z(-25^\circ\text{C})/Z(+20^\circ\text{C}) \leq 1.15$ |
| Endurance | The following specifications shall be satisfied when the capacitors are restored to 20°C after the rated voltage is applied for 2,000 hours at 125°C. | Appearance NO significant damage. |
| | | Capacitance change $\leq \pm 20\%$ of the initial value. |
| | | DF (tan δ) $\leq 150\%$ of the initial specified value. |
| | | ESR $\leq 150\%$ of the initial specified value. |
| | | Leakage current \leq The initial specified value. |
| Damp Heag (Steady State) | The following specifications shall be satisfied when the capacitors are restored to 20°C after subjecting them to store 60°C, 90 to 95% RH for 1,000 hours, without DC applied. | Appearance NO significant damage. |
| | | Capacitance change $\leq \pm 20\%$ of the initial value. |
| | | DF (tan δ) $\leq 150\%$ of the initial specified value. |
| | | ESR $\leq 150\%$ of the initial specified value. |
| | | Leakage current \leq The initial specified value. |
| Surge Voltage | The capacitors shall be subjected to 1,000 cycles each consisting of charge with the surge voltages specified at 105°C for 30 seconds through a protective resistor (R = 1 kΩ) and discharge for 5 minutes 30 seconds. | Appearance NO significant damage. |
| | | Capacitance change $\leq \pm 20\%$ of the initial value. |
| | | DF (tan δ) $\leq 150\%$ of the initial specified value. |
| | | ESR $\leq 150\%$ of the initial specified value. |
| | | Leakage current \leq The initial specified value. |

※ Note : If any doubt arises, measure the leakage current after following voltage treatment.
Voltage treatment : DC rated voltage are applied to the capacitors for 120 minutes at 125°C.

Frequency Coefficient for Ripple Current

| Frequency (Hz) | 120Hz ≤ f < 1KHz | 1KHz ≤ f < 10KHz | 10KHz ≤ f < 100KHz | 100KHz ≤ f < 500KHz |
|----------------|------------------|------------------|--------------------|---------------------|
| Coefficient | 0.05 | 0.3 | 0.7 | 1 |

Marking & Dimensions

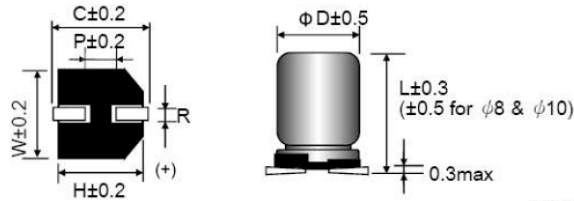

(UNIT: mm)

| ΦDxL | ΦD | L | W | H | C | R | P |
|---------|------|------|------|------|------|---------|-----|
| 6.3x9.5 | 6.3 | 9.5 | 6.6 | 6.6 | 7.3 | 0.5~0.8 | 2.1 |
| 8x9.5 | 8.0 | 9.5 | 8.3 | 8.3 | 9.0 | 0.8~1.1 | 3.2 |
| 8x12 | 8.0 | 12.0 | 8.3 | 8.3 | 9.0 | 0.8~1.1 | 3.2 |
| 10x10.5 | 10.0 | 10.5 | 10.3 | 10.3 | 11.0 | 0.8~1.1 | 4.6 |
| 10x12.5 | 10.0 | 12.5 | 10.3 | 10.3 | 11.0 | 0.8~1.1 | 4.6 |

PSF SERIES STANDARD CHARACTERISTICS LIST

| Rated Voltage (S.V) | Cap (μF) | Size DxL | Leakage current (μA) max. ※2 | ESR(mΩ) max. 100k to 300kHz / 20°C | Rated Ripple Current (mA rms/100kHz) | | D.F (tanδ) max. 120Hz / 20°C |
|------------------------|-------------|----------|---------------------------------|--|--------------------------------------|-------------|---------------------------------|
| | | | | | -55°C≤105°C | 105°C≤125°C | |
| 6.3 (7.2) | 470 | 6.3x9.5 | 592 | 25 | 3,800 | 1,267 | 0.12 |
| | 680 | 8x9.5 | 857 | 25 | 4,000 | 1,333 | 0.12 |
| | 1000 | 8x12 | 1,260 | 20 | 4,200 | 1,400 | 0.12 |
| | 1200 | 10x10.5 | 1,512 | 25 | 5,500 | 1,833 | 0.12 |
| | 1800 | 10x12.5 | 2,268 | 20 | 6,100 | 2,033 | 0.12 |
| 10 (11.5) | 330 | 6.3x9.5 | 660 | 25 | 3,700 | 1,233 | 0.12 |
| | 560 | 8x9.5 | 1,120 | 25 | 4,000 | 1,333 | 0.12 |
| | 680 | 8x12 | 1,360 | 20 | 4,500 | 1,500 | 0.12 |
| | 820 | 10x10.5 | 1,640 | 25 | 4,200 | 1,400 | 0.12 |
| | 1000 | 10x10.5 | 2,000 | 25 | 4,500 | 1,500 | 0.12 |
| | 1200 | 10x12.5 | 2,400 | 20 | 5,600 | 1,867 | 0.12 |
| 16 (18.4) | 220 | 6.3x9.5 | 704 | 25 | 2,850 | 950 | 0.12 |
| | 330 | 8x9.5 | 1,056 | 25 | 4,000 | 1,333 | 0.12 |
| | 470 | 8x12 | 1,504 | 20 | 4,500 | 1,500 | 0.12 |
| | 680 | 10x10.5 | 2,176 | 25 | 5,100 | 1,700 | 0.12 |
| | 820 | 10x12.5 | 2,624 | 20 | 5,600 | 1,867 | 0.12 |
| 20 (23.0) | 120 | 6.3x9.5 | 480 | 25 | 2,510 | 837 | 0.12 |
| | 220 | 8x9.5 | 880 | 25 | 2,750 | 917 | 0.12 |
| | 270 | 8x12 | 1,080 | 20 | 2,950 | 983 | 0.12 |
| | 330 | 10x10.5 | 1,320 | 25 | 4,700 | 1,567 | 0.12 |
| | 470 | 10x12.5 | 1,880 | 20 | 4,950 | 1,650 | 0.12 |
| 25 (28.8) | 100 | 6.3x9.5 | 500 | 40 | 2,380 | 793 | 0.12 |
| | 180 | 8x9.5 | 900 | 30 | 2,900 | 967 | 0.12 |
| | 220 | 8x9.5 | 1,100 | 28 | 3,500 | 1,167 | 0.12 |
| | 330 | 10x10.5 | 1,650 | 30 | 4,250 | 1,417 | 0.12 |
| | 470 | 10x12.5 | 2,350 | 28 | 4,500 | 1,500 | 0.12 |
| 35 (40.3) | 56 | 6.3x9.5 | 392 | 60 | 2,300 | 767 | 0.12 |
| | 100 | 8x9.5 | 700 | 50 | 2,500 | 833 | 0.12 |
| | 120 | 8x12 | 840 | 30 | 2,950 | 983 | 0.12 |
| | 150 | 10x10.5 | 1,050 | 30 | 2,950 | 983 | 0.12 |
| | 220 | 10x12.5 | 1,540 | 28 | 3,400 | 1,133 | 0.12 |

※※ 1. Capacitance tolerance : ±20% (M)

※※ 2. After 2 minutes

PSG Series

- Super low ESR, High ripple current capability
- Rated Voltage: 2.5 ~ 63V
- Endurance: 15,000 hours at 105°C
- Applications: Motherboards, Servers, VGA, etc.,
- RoHS Compliant
- Halogen Free compliant

Specifications

| Items | Conditions | Characteristics | |
|---|---|--|--|
| Category Temperature Range | - | -55 to +105°C | |
| Rated Voltage Range | - | 2.5 ~ 63V | |
| Capacitance Tolerance | at 20°C, 120Hz | ±20% (M) | |
| Surge Voltage | at 105°C | Rated voltage x 1.15V | |
| Leakage Current | at 20°C after 2 minutes | $I \leq 0.2CV$ or $300(\mu A)$ Whichever is greater measured, after 2 minutes application of rated working voltage at +20°C. | |
| Dissipation Factor (tan δ) | at 20°C, 120Hz | Please see the attached characteristics list | |
| Characteristics of Impedance at low, high temperature | at -55°C, 100kHz | $Z(-55^\circ C)/Z(+20^\circ C) \leq 1.25$ | |
| | at -25°C, 100kHz | $Z(-25^\circ C)/Z(+20^\circ C) \leq 1.15$ | |
| Endurance | The following specifications shall be satisfied when the capacitors are restored to 20°C after the rated voltage is applied for 15,000 hours at 105°C. | Appearance | NO significant damage. |
| | | Capacitance change | $\leq \pm 20\%$ of the initial value. |
| | | DF (tan δ) | $\leq 150\%$ of the initial specified value. |
| | | ESR | $\leq 150\%$ of the initial specified value. |
| | | Leakage current | \leq The initial specified value. |
| Damp Heag (Steady State) | The following specifications shall be satisfied when the capacitors are restored to 20°C after subjecting them to store at 60°C, 90 to 95% RH for 1,000 hours, without DC applied. | Appearance | NO significant damage. |
| | | Capacitance change | $\leq \pm 20\%$ of the initial value. |
| | | DF (tan δ) | $\leq 150\%$ of the initial specified value. |
| | | ESR | $\leq 150\%$ of the initial specified value. |
| | | Leakage current | \leq The initial specified value. |
| Surge Voltage | The capacitors shall be subjected to 1,000 cycles each consisting of charge with the surge voltages specified at 105°C for 30 seconds through a protective resistor (R=1 k Ω) and discharge for 5 minutes 30 seconds. | Appearance | NO significant damage. |
| | | Capacitance change | $\leq \pm 20\%$ of the initial value. |
| | | DF (tan δ) | $\leq 150\%$ of the initial specified value. |
| | | ESR | $\leq 150\%$ of the initial specified value. |
| | | Leakage current | \leq The initial specified value. |

※ Note: If any doubt arises, measure the leakage current after following voltage treatment.
Voltage treatment: DC rated voltage are applied to the capacitors for 120 minutes at 105°C.

Frequency Coefficient for Ripple Current

| Frequency | 120Hz $\leq f < 1$ kHz | 1kHz $\leq f < 10$ kHz | 10kHz $\leq f < 100$ kHz | 100kHz $\leq f < 500$ kHz |
|-------------|------------------------|------------------------|--------------------------|---------------------------|
| Coefficient | 0.05 | 0.3 | 0.7 | 1 |

DIMENSIONS

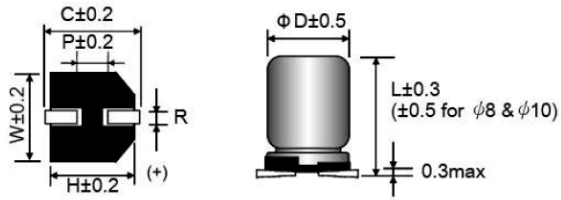

(Unit: mm)

| Size Code | ØD | L | W | H | C | R | P |
|-----------|------|------|------|------|------|---------|-----|
| 5x6 | 5.0 | 6.0 | 5.3 | 5.3 | 6.0 | 0.5~0.8 | 1.4 |
| 6.3x6 | 6.3 | 6.0 | 6.6 | 6.6 | 7.3 | 0.5~0.8 | 2.1 |
| 6.3x9.5 | 6.3 | 9.5 | 6.6 | 6.6 | 7.3 | 0.5~0.8 | 2.1 |
| 8x7 | 8.0 | 7.0 | 8.3 | 8.3 | 9.3 | 0.5~0.8 | 3.2 |
| 8x9.5 | 8.0 | 9.5 | 8.3 | 8.3 | 9.3 | 0.8~1.1 | 3.2 |
| 8x12 | 8.0 | 12.0 | 8.3 | 8.3 | 9.0 | 0.8~1.1 | 3.2 |
| 10x8 | 10.0 | 8.0 | 10.3 | 10.3 | 11.0 | 0.8~1.1 | 4.6 |
| 10x10.5 | 10.0 | 10.5 | 10.3 | 10.3 | 11.0 | 0.8~1.1 | 4.6 |
| 10x12.5 | 10.0 | 12.5 | 10.3 | 10.3 | 11.0 | 0.8~1.1 | 4.6 |

PSG SERIES STANDARD CHARACTERISTICS LIST

| Rated Voltage (S.V.) | Cap (µF) | Size DxL | Leakage current (µA) max. ※2 | ESR (mΩ) max. 100k to 300kHz / 20°C | Rated Ripple Current (mA rms) 100kHz / 105°C | D.F. (tan δ) max. 120Hz / 20°C |
|----------------------|----------|----------|------------------------------|-------------------------------------|--|--------------------------------|
| 2.5 (2.9) | 220 | 5x6 | 300 | 40 | 1,620 | 0.12 |
| | 330 | 6.3x6 | 300 | 20 | 2,690 | 0.12 |
| | 820 | 6.3x9.5 | 410 | 18 | 3,200 | 0.12 |
| | 820 | 8x9.5 | 410 | 18 | 4,520 | 0.12 |
| | 1500 | 8x9.5 | 750 | 18 | 4,520 | 0.12 |
| | 1800 | 8x12 | 900 | 12 | 5,200 | 0.12 |
| | 2700 | 10x12.5 | 1,350 | 12 | 5,500 | 0.12 |
| 4 (4.6) | 68 | 5x6 | 300 | 40 | 1,500 | 0.12 |
| | 150 | 6.3x6 | 300 | 24 | 2,200 | 0.12 |
| | 680 | 6.3x9.5 | 544 | 16 | 3,200 | 0.12 |
| | 680 | 8x7 | 544 | 20 | 3,400 | 0.12 |
| | 1000 | 8x9.5 | 800 | 16 | 4,500 | 0.12 |
| | 1500 | 8x12 | 1,200 | 14 | 5,100 | 0.12 |
| | 1800 | 10x12.5 | 1,440 | 12 | 5,500 | 0.12 |
| | 2200 | 10x12.5 | 2,000 | 12 | 5,500 | 0.12 |
| 6.3 (7.2) | 100 | 5x6 | 300 | 40 | 1,500 | 0.12 |
| | 220 | 5x7 | 300 | 20 | 1,600 | 0.12 |
| | 220 | 6.3x6 | 300 | 20 | 2,400 | 0.12 |
| | 560 | 6.3x9.5 | 705 | 20 | 3,200 | 0.12 |
| | 560 | 8x7 | 705 | 20 | 3,300 | 0.12 |
| | 820 | 8x9.5 | 1,033 | 15 | 4,450 | 0.12 |
| | 1000 | 8x9.5 | 1,260 | 15 | 4,520 | 0.12 |
| | 1200 | 8x12 | 1,512 | 12 | 5,020 | 0.12 |

| Rated Voltage (S.V.) | Cap (μF) | Size DxL | Leakage current (μA) max. ✖2 | ESR (mΩ) max. 100k to 300kHz / 20°C | Rated Ripple Current (mA rms) 100kHz / 105°C | D.F. (tan δ) max. 120Hz / 20°C |
|----------------------|-----------|----------|------------------------------|-------------------------------------|--|--------------------------------|
| 6.3 (7.2) | 1500 | 10x10.5 | 1,890 | 15 | 5020 | 0.12 |
| | 1800 | 10x12.5 | 2,268 | 12 | 5400 | 0.12 |
| | 2200 | 10x12.5 | 2,772 | 12 | 5,500 | 0.12 |
| 10 (11.5) | 68 | 5x6 | 300 | 40 | 1,500 | 0.12 |
| | 120 | 6.3x6 | 300 | 25 | 2,420 | 0.12 |
| | 150 | 8 x7 | 300 | 22 | 2,450 | 0.12 |
| | 330 | 6.3x9.5 | 660 | 20 | 3,200 | 0.12 |
| | 560 | 8 x9.5 | 1,120 | 16 | 4,450 | 0.12 |
| | 680 | 8 x9.5 | 1,360 | 16 | 4,450 | 0.12 |
| | 820 | 8x12 | 1,640 | 14 | 4,850 | 0.12 |
| | 1000 | 10x10.5 | 2,000 | 15 | 5,020 | 0.12 |
| | 1200 | 10x10.5 | 2,400 | 15 | 5,200 | 0.12 |
| | 1500 | 10x12.5 | 3,000 | 14 | 5,400 | 0.12 |
| | 16 (18.4) | 100 | 6.3x6 | 320 | 24 | 2,400 |
| 180 | | 6.3x9.5 | 576 | 15 | 3,200 | 0.12 |
| 220 | | 6.3x9.5 | 704 | 15 | 3,200 | 0.12 |
| 270 | | 6.3x9.5 | 864 | 15 | 3,200 | 0.12 |
| 270 | | 8x7 | 864 | 20 | 3,400 | 0.12 |
| 270 | | 8x9.5 | 864 | 20 | 4,400 | 0.12 |
| 470 | | 8x9.5 | 1,504 | 25 | 4,400 | 0.12 |
| 560 | | 8x12 | 1,792 | 16 | 4,820 | 0.12 |
| 680 | | 10x10.5 | 2,176 | 18 | 5,200 | 0.12 |
| 1000 | | 10x12.5 | 3,200 | 16 | 5,400 | 0.12 |
| 20 (23.0) | 68 | 6.3x6 | 300 | 38 | 1,450 | 0.12 |
| | 180 | 6.3x9.5 | 720 | 30 | 1,450 | 0.12 |
| | 330 | 8x9.5 | 1320 | 30 | 1,890 | 0.12 |
| | 470 | 8x12 | 1880 | 28 | 3,320 | 0.12 |
| | 560 | 10x10.5 | 2240 | 28 | 3,320 | 0.12 |
| | 680 | 10x12.5 | 2720 | 28 | 4,220 | 0.12 |
| 25 (28.8) | 47 | 6.3x6 | 300 | 40 | 1,200 | 0.12 |
| | 100 | 6.3x9.5 | 500 | 30 | 2,000 | 0.12 |
| | 100 | 8x7 | 500 | 40 | 2,000 | 0.12 |
| | 150 | 8x9.5 | 750 | 35 | 3,000 | 0.12 |
| | 220 | 8x12 | 1100 | 32 | 3,500 | 0.12 |
| | 330 | 10x10.5 | 1650 | 35 | 3,800 | 0.12 |
| | 470 | 10x12.5 | 2350 | 32 | 4,000 | 0.12 |
| 35 (40.3) | 22 | 6.3x6 | 300 | 80 | 1,450 | 0.12 |
| | 56 | 6.3x9.5 | 392 | 50 | 2,300 | 0.12 |
| | 68 | 6.3x9.5 | 476 | 50 | 2,300 | 0.12 |
| | 68 | 8x7 | 476 | 60 | 2,500 | 0.12 |
| | 100 | 8x12 | 700 | 28 | 2,750 | 0.12 |
| | 220 | 10x12.5 | 1,540 | 28 | 3,200 | 0.12 |

| Rated Voltage (S.V.) | Cap (μF) | Size DxL | Leakage current (μA) max. ※2 | ESR (mΩ) max. 100k to 300kHz / 20°C | Rated Ripple Current (mA rms) 100kHz / 105°C | D.F. (tan δ) max. 120Hz / 20°C |
|----------------------|----------|----------|------------------------------|-------------------------------------|--|--------------------------------|
| 50 (57.5) | 12 | 6.3x6 | 300 | 100 | 660 | 0.12 |
| | 33 | 6.3x9.5 | 330 | 50 | 900 | 0.12 |
| | 47 | 8x9.5 | 470 | 45 | 1,850 | 0.12 |
| | 100 | 10x12.5 | 1,000 | 28 | 2,560 | 0.12 |
| | 180 | 10x12.5 | 1,800 | 28 | 2,560 | 0.12 |
| 63 (72.5) | 22 | 6.3x9.5 | 300 | 50 | 1,800 | 0.12 |
| | 33 | 6.3x9.5 | 416 | 50 | 1,800 | 0.12 |
| | 47 | 8x12 | 592 | 36 | 2,200 | 0.12 |
| | 56 | 10x10.5 | 705 | 32 | 2,350 | 0.12 |
| | 100 | 10x12.5 | 1,260 | 28 | 2,550 | 0.12 |
| | 150 | 10x12.5 | 1,890 | 28 | 2,550 | 0.12 |

※1. Capacitance tolerance : ±20%(M)

※2. After 2 minutes

PSH Series

- Super low ESR, Long life capability
- Rated Voltage: 4.0 ~ 50V
- Endurance: 20,000 hours at 105°C
- Applications: DC/DC Converter, Voltage Regulators, Decoupling, Applications for Computer Motherboards etc.,
- RoHS Compliant
- Halogen Free compliant

Specifications

| Items | Conditions | Characteristics |
|---|---|--|
| Category Temperature Range | - | -55 to +105°C |
| Rated Voltage Range | - | 4.0 ~ 50V |
| Capacitance Tolerance | at 20°C, 120 Hz | ±20% (M) |
| Surge Voltage | at 105°C | Rated voltage x 1.15V |
| Leakage Current | at 20°C after 2 minutes | $I \leq 0.2CV$ or $300(\mu A)$ Whichever is greater measured, after 2 minutes application of rated working voltage at +20°C. |
| Dissipation Factor (tan δ) | at 20°C, 120 Hz | Please see the attached characteristics list |
| Characteristics of Impedance at low, high temperature | at -55°C, | $Z(-55^\circ C)/Z(+20^\circ C) \leq 1.25$ |
| | at -25°C, | $Z(-25^\circ C)/Z(+20^\circ C) \leq 1.15$ |
| Endurance | The following specifications shall be satisfied when the capacitors are restored to 20°C after the rated voltage is applied for 20,000 hours at 105°C. | Appearance NO significant damage. |
| | | Capacitance change $\leq \pm 20\%$ of the initial value. |
| | | DF (tan δ) $\leq 150\%$ of the initial specified value. |
| | | ESR $\leq 150\%$ of the initial specified value. |
| | | Leakage current \leq The initial specified value. |
| Damp Heag (Steady State) | The following specifications shall be satisfied when the capacitors are restored to 20°C after subjecting them to store at 60°C, 90 to 95% RH for 1,000 hours, without DC applied. | Appearance NO significant damage. |
| | | Capacitance change $\leq \pm 20\%$ of the initial value. |
| | | DF (tan δ) $\leq 150\%$ of the initial specified value. |
| | | ESR $\leq 150\%$ of the initial specified value. |
| | | Leakage current \leq The initial specified value. |
| Surge Voltage | The capacitors shall be subjected to 1,000 cycles each consisting of charge with the surge voltages specified at 105°C for 30 seconds through a protective resistor (R=1 k Ω) and discharge for 5 minutes 30 seconds. | Appearance NO significant damage. |
| | | Capacitance change $\leq \pm 20\%$ of the initial value. |
| | | DF (tan δ) $\leq 150\%$ of the initial specified value. |
| | | ESR $\leq 150\%$ of the initial specified value. |
| | | Leakage current \leq The initial specified value. |

※ Note: If any doubt arises, measure the leakage current after following voltage treatment.
Voltage treatment: DC rated voltage are applied to the capacitors for 120 minutes at 105°C.

Frequency Coefficient for Ripple Current

| Frequency | 120Hz $\leq f < 1$ kHz | 1kHz $\leq f < 10$ kHz | 10kHz $\leq f < 100$ kHz | 100kHz $\leq f < 500$ kHz |
|-------------|------------------------|------------------------|--------------------------|---------------------------|
| Coefficient | 0.05 | 0.3 | 0.7 | 1 |

DIMENSIONS

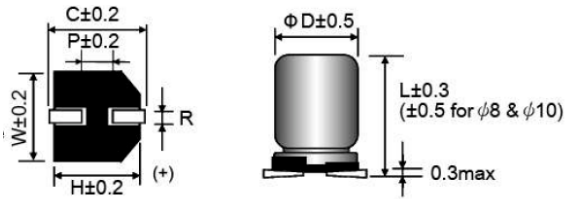

(Unit: mm)

| Size Code | ΦD | L | W | H | C | R | P |
|-----------|------|------|------|------|------|---------|-----|
| 6.3 x6 | 6.3 | 6.0 | 6.6 | 6.6 | 7.3 | 0.5~0.8 | 2.1 |
| 6.3x7 | 6.3 | 7.0 | 6.6 | 6.6 | 7.3 | 0.5~0.8 | 2.1 |
| 6.3x9.5 | 6.3 | 9.5 | 6.6 | 6.6 | 7.3 | 0.5~0.8 | 2.1 |
| 8x7 | 8.0 | 7.0 | 8.3 | 8.3 | 9.3 | 0.5~0.8 | 3.2 |
| 8x9.5 | 8.0 | 9.5 | 8.3 | 8.3 | 9.3 | 0.8~1.1 | 3.2 |
| 8x12 | 8.0 | 12.0 | 8.3 | 8.3 | 9.0 | 0.8~1.1 | 3.2 |
| 10x10.5 | 10.0 | 10.5 | 10.3 | 10.3 | 11.0 | 0.8~1.1 | 4.6 |
| 10x12.5 | 10.0 | 12.5 | 10.3 | 10.3 | 11.0 | 0.8~1.1 | 4.6 |

PSH SERIES STANDARD CHARACTERISTICS LIST

| Rated Voltage (S.V.) | Cap (μF) | Size DxL | Leakage current (μA) max.※2 | ESR (mΩ) max. 100k to 300kHz / 20°C | Rated Ripple Current (mA rms) 100kHz / 105°C | D.F.(tanδ) max. 120Hz / 20°C |
|----------------------|----------|----------|-----------------------------|-------------------------------------|--|------------------------------|
| 4 (4.6) | 220 | 6.3X6 | 300 | 20 | 2,800 | 0.12 |
| | 560 | 6.3X9.5 | 448 | 20 | 3,500 | 0.12 |
| | 560 | 8x7 | 448 | 18 | 3,700 | 0.12 |
| | 820 | 8X9.5 | 656 | 15 | 3,500 | 0.12 |
| | 1200 | 8X12 | 960 | 15 | 4,450 | 0.12 |
| | 1500 | 10x10.5 | 1,200 | 13 | 4,200 | 0.12 |
| | 2200 | 10x12.5 | 1,760 | 13 | 5,400 | 0.12 |
| 6.3 (7.2) | 100 | 6.3x6 | 300 | 35 | 2,400 | 0.12 |
| | 220 | 6.3x6 | 300 | 22 | 2,600 | 0.12 |
| | 470 | 6.3x9.5 | 592 | 22 | 3,200 | 0.12 |
| | 560 | 6.3x9.5 | 705 | 22 | 3,200 | 0.12 |
| | 820 | 8X9.5 | 1,033 | 20 | 3,850 | 0.12 |
| | 1000 | 8X12 | 1,260 | 20 | 4,250 | 0.12 |
| | 1200 | 10x10.5 | 1,512 | 18 | 4,350 | 0.12 |
| | 1800 | 10x12.5 | 2,268 | 18 | 5,200 | 0.12 |
| 10 (11.5) | 68 | 6.3X6 | 300 | 30 | 2,400 | 0.12 |
| | 100 | 6.3x6 | 300 | 30 | 2,400 | 0.12 |
| | 220 | 6.3X7 | 440 | 30 | 2,500 | 0.12 |
| | 330 | 6.3x9.5 | 660 | 30 | 3,150 | 0.12 |
| | 560 | 8X9.5 | 1,120 | 25 | 3,850 | 0.12 |
| | 680 | 8x12 | 1,360 | 25 | 4,150 | 0.12 |
| | 820 | 10x10.5 | 1,640 | 20 | 4,250 | 0.12 |
| | 1000 | 10x10.5 | 2,000 | 20 | 4,250 | 0.12 |
| | 1200 | 10x12.5 | 2,400 | 20 | 5,100 | 0.12 |

| Rated Voltage (S.V.) | Cap (μF) | Size DxL | Leakage current (μA) max. ※2 | ESR (mΩ) max. 100k to 300kHz / 20°C | Rated Ripple Current (mA rms) 100kHz / 105°C | D.F.(tanδ) max. 120Hz / 20°C |
|----------------------|----------|-----------|------------------------------|-------------------------------------|--|------------------------------|
| 16 (18.4) | 100 | 6.3×6 | 320 | 30 | 2,200 | 0.12 |
| | 220 | 6.3×9.5 | 704 | 30 | 3,050 | 0.12 |
| | 330 | 8×9.5 | 1056 | 20 | 3,450 | 0.12 |
| | 470 | 8×12 | 1504 | 22 | 4,050 | 0.12 |
| | 680 | 10 × 10.5 | 2176 | 20 | 4,150 | 0.12 |
| | 820 | 10×12.5 | 2624 | 20 | 5,100 | 0.12 |
| 25 (28.8) | 47 | 6.3×6 | 300 | 40 | 1,500 | 0.12 |
| | 100 | 6.3×9.5 | 500 | 40 | 2,800 | 0.12 |
| | 180 | 8×9.5 | 900 | 30 | 3,250 | 0.12 |
| | 220 | 8×12 | 1100 | 30 | 3,900 | 0.12 |
| | 330 | 10×10.5 | 1650 | 20 | 4,100 | 0.12 |
| | 470 | 10×12.5 | 2350 | 25 | 4,500 | 0.12 |
| 35 (40.3) | 22 | 6.3×6 | 300 | 70 | 1,450 | 0.12 |
| | 68 | 6.3×9.5 | 476 | 60 | 1,500 | 0.12 |
| | 120 | 8×9.5 | 840 | 50 | 1,800 | 0.12 |
| | 150 | 8×12 | 1050 | 50 | 2,850 | 0.12 |
| | 220 | 10×10.5 | 1540 | 40 | 2,950 | 0.12 |
| | 270 | 10×12.5 | 1890 | 40 | 3,200 | 0.12 |
| 50 (57.5) | 10 | 6.3×6 | 300 | 60 | 1,400 | 0.12 |
| | 33 | 6.3×9.5 | 330 | 30 | 1,700 | 0.12 |
| | 47 | 8×9.5 | 470 | 30 | 2,000 | 0.12 |
| | 68 | 8×12 | 680 | 28 | 2,200 | 0.12 |
| | 100 | 10×10.5 | 1000 | 30 | 2,300 | 0.12 |
| | 100 | 10×12.5 | 1000 | 28 | 2,650 | 0.12 |

※ 1. Capacitance tolerance: ±20%(M)

※ 2. After 2 minutes

Packing specifications (Lead type)

| ΦD x L | Bags / Inner Box | Layer Quantity | Quantity (pcs/bag) | Total Quantity (pcs / carton) | Size of Inner Box | Size of Out Box |
|-----------|------------------|----------------|--------------------|-------------------------------|-------------------|-----------------|
| 5x6~7 | 15 | 2 | 1000 | 30,000 | 267 X | 546 X |
| 5x8~12 | 10 | 2 | 1000 | 20,000 | | |
| 6.3x6~9 | 10 | 2 | 1000 | 20,000 | 260 | 277 |
| 6.3x10~12 | 8 | 2 | 500 | 16,000 | X | X |
| 8x7~12 | 10 | 2 | 500 | 10,000 | 135 | 152 |
| 8x14~16 | 8 | 2 | 500 | 8,000 | | |
| 8x20 | 6 | 2 | 500 | 6,000 | | |
| 10x8~12 | 11 | 2 | 500 | 4,400 | | |
| 10x16~22 | 9 | 2 | 500 | 3,600 | | |

TAPING PACKAGE

| Item | Taping packing | | | | | | |
|-------------|----------------|---------|---------|---------|-----------|----------------|------------|
| | ΦD(mm) | W±5(mm) | L±5(mm) | H±5(mm) | Qty.(pcs) | Inner Box(pcs) | Total(pcs) |
| 5x6~12 | | 235 | 320 | 51 | 2000 | 10 | 20,000 |
| 6.3x (6~12) | | 235 | 320 | 51 | 1500 | | 15,000 |
| 8x7~16 | | 235 | 320 | 51 | 1000 | | 10,000 |
| 8x20 | | 255 | 320 | 51 | 1000 | 8 | 8,000 |
| 10x8~22 | | 218 | 325 | 51 | 600 | 5 | 3,000 |

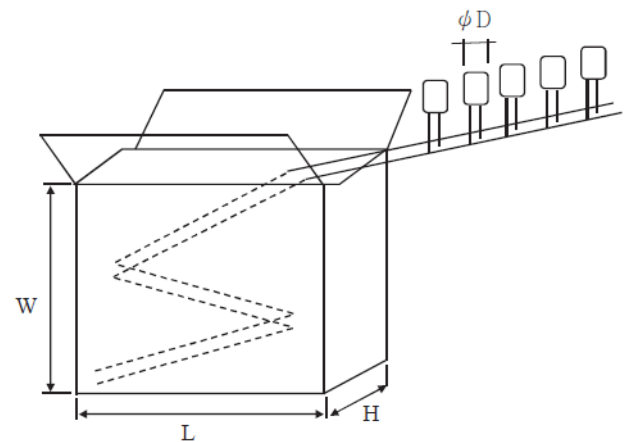

Carrier Tape

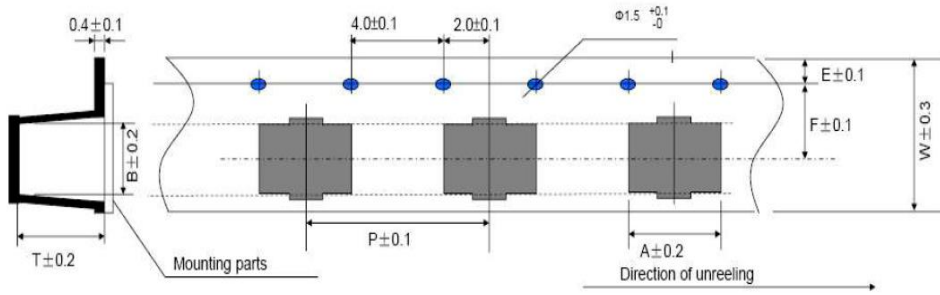

| Size (φ x L) | Item | | | | | | |
|-------------------------------|------|------|----|------|------|------|--------|
| | A | B | w | F | E | P | T |
| 5x6.0-7.Q | 5.7 | 5.7 | 12 | 5.5 | 1.75 | 12.0 | 7.5 |
| 6.3x4.5 | 7.0 | 7.0 | 16 | 7.5 | 1.75 | 12.0 | 4.8 |
| 6.3x5.7-6.Q | 7.0 | 7.0 | 16 | 7.5 | 1.75 | 12.0 | 6.5 |
| Aluminum Casex6.Q (=6.8mm) | 7.0 | 7.0 | 16 | 7.5 | 1.75 | 12.0 | 8.2 |
| 6.3x7.0 | 7.0 | 7.0 | 16 | 7.5 | 1.75 | 12.0 | 8.2 |
| 6.3x7.7 | 7.0 | 7.0 | 16 | 7.5 | 1.75 | 12.0 | 8.2 |
| 6.3x8.Q | 7.0 | 7.0 | 16 | 7.5 | 1.75 | 12.0 | 8.2 |
| Aluminum Casex8.Q (=9.3mm) | 7.0 | 7.0 | 16 | 7.5 | 1.75 | 12.0 | 9.3 |
| 6.3x9.5-10 | 7.0 | 7.0 | 16 | 7.5 | 1.75 | 12.0 | 10.0 |
| 8x7.0 | 8.7 | 8.7 | 24 | 11.5 | 1.75 | 16.0 | 8.8 |
| 8x9.5 | 8.7 | 8.7 | 24 | 11.5 | 1.75 | 16.0 | 11.0 |
| 8x12 | 8.7 | 8.7 | 24 | 11.5 | 1.75 | 16.0 | 13.0 |
| 10x8 | 10.7 | 10.7 | 24 | 11.5 | 1.75 | 16.0 | 8.5 |
| 10x10 | 10.7 | 10.7 | 24 | 11.5 | 1.75 | 16.0 | 11.0 |
| 10x10.5 | 10.7 | 10.7 | 24 | 11.5 | 1.75 | 16.0 | 11.0 |
| 10x12.5 | 10.7 | 10.7 | 24 | 11.5 | 1.75 | 16.0 | 13/13. |

Reel

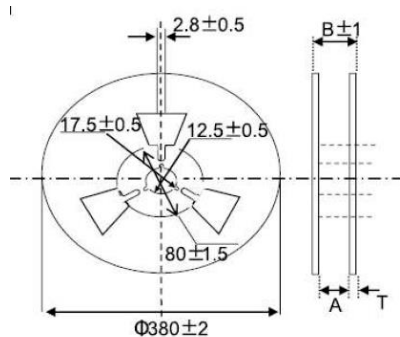

Polarity

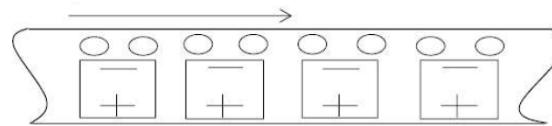

| Size code (φ x L) | A | 8±1 | T±0.5 |
|----------------------|----|-----|-------|
| 5 x 6 ~ 7 | 14 | 18 | 2.0 |
| 6.3x6 ~ 10 | 18 | 22 | |
| 8x7 ~ 12 | 26 | 30 | |
| 10x8 ~ 12 | 26 | 30 | |

| Size Code φD x L | W1 | W2 | Quantity / Reel | Size of Inner Box (L)x(W)x(H) | Size of Out Box (L)x(W)x(H) |
|---------------------|----------|----------|-----------------|----------------------------------|--------------------------------|
| 5x6 | 14.0±1.0 | 18.0±1.0 | 1000 pcs. | 385x385x106 | 412x403x255 |
| 6.3x (6~8) | 18.0±1.0 | 22.0±1.0 | 1000 pcs. | 385x385x125 | 412x403x293 |
| 6.3x9.5 | 18.0±1.0 | 22.0±1.0 | 800 pcs. | 385x385x125 | 412x403x293 |
| 8x(7~10) | 26.0±1.0 | 30.0±1.0 | 500 pcs. | 385x385x106 | 412x403x255 |
| 10x(8~10.5) | 26.0±1.0 | 30.0±1.0 | 500 pcs. | 385x385x106 | 412x403x255 |
| (8~10)x12.5 | 26.0±1.0 | 30.0±1.0 | 400 pcs. | 385x385x106 | 412x403x255 |

Application Guidelines for Aluminum Electrolytic Capacitors

Caution During Circuit Design

1. Please make sure the application and mounting conditions to which the capacitor will be exposed are within the conditions specified in the catalog of alternate product specification (Referred as to specification here after).
2. Design Aluminum Electrolytic Capacitors, please pay attention to the points listed below
 1. The capacitor shall not be used in an ambient temperature which exceeds the operating temperature specified in the specification
 2. Do not apply excessive current which exceeds the allowable ripple current
 3. Make sure that no excess voltage (that is higher than the rated voltage) is applied to the capacitor.
 - a. Please pay attention that the peak voltage, which is DC voltage overlapped by ripple current, should not exceed the rated voltage.
 - b. In the case where more than 2 aluminum electrolytic capacitors are used in series, please make sure that applied voltage will be lower than rated voltage and the voltage be will applied to each capacitor equally using a balancing resistor in parallel with the capacitors.
 4. Aluminum electrolytic capacitors are polarized Make sure that no reverse se voltage or AC voltage is applied to the capacitors. Please apply bi-polarized Capacitor to reverse polarity circuit but bi-polarized capacitors cannot be applied to AC circuit.
3. Appropriate capacitors which comply with the life requirement of the products should be selected when designing the circuit.
4. For a circuit that repeats rapid charging/discharging of electricity, an appropriate capacitor that is capable of enduring such a condition must be used.
5. Aluminum case, cathode lead wire, anode lead wire and circuit pattern must be isolated
6. The sleeve of capacitors is not recognized as an insulator, and therefore, the standard capacitor should not be used in a place where insulation function is needed.
If you require a higher grade of insulating sleeve, please consult us
7. Capacitors may fail if they are used under the following conditions:
 - a. Damp conditions such as water, saltwater spray, or oil spray or fumes. High humidity or humidity condensation situations.
 - b. In an atmosphere with toxic gasses (such as hydrogen sulfide, sulfurous acid, nitrous acid, chlorine, ammonia, etc)
 - c. Being exposed to direct sunlight, ozone, Ultraviolet ray, or radiation
 - d. Being exposed to acidic or alkaline solutions
 - e. Under severe conditions where vibration and / or mechanical shock exceed the applicable ranges of the specification
8. In designing a circuit, the following matters should be ensured 1n advance to the capacitor assembly on the P.C board.
 - (1) Design the appropriate hole spacing to match the lead pitch of capacitors.
 - (2) Do not locate any wiring and circuit patterns directly above the capacitor vent. Ensure enough free space above the capacitor vent
 $\varnothing 8(6.3) \sim \varnothing 16: 2\text{mm}$
 $\varnothing 8 \sim \varnothing 35: 3\text{mm}$
 $\geq \varnothing 40: 5\text{mm}$
 - (3) Do not design a circuit board so that heat generating components are placed near an aluminum electrolytic capacitor or reverse side of P.C. board (under the capacitor)
 - (4) Do not print any copper trace under the seal (terminal) side of a capacitor. Copper traces should be 2mm spaced apart from the side of the capacitor body.
 - (5) For a screw terminal type capacitor. Tighten in g the terminal screws and the mounting clamp should be within the maximum torque specified in the catalogs or product specifications. Do not mount a screw terminal type capacitor with the terminal facing downward. Also, if the body of a capacitor is installed horizontally such as being laid on its side. Do not position the pressure relief vent downward
9. Electrical characteristics may vary depending on changes 111 temperature and frequency. Please consider this variation when you design circuits
10. When you mount capacitors on the double-sided P.C. boards, avoid excess substrate holes and vias to capacitor location.
11. When you install more than 2 capacitors in parallel, consider the balance of current flowing through the capacitors.
12. If more than 2 aluminum electrolytic capacitors are used 1n series. make sure the applied voltage will be lower than the rated voltage and that voltage will be applied to each capacitor equally using a balancing resistor in parallel with each capacitor.

Application Guidelines for Aluminum Electrolytic Capacitors

Caution for Assembling Capacitors

1. Once a capacitor has been assembled in the set and power applied, even if a capacitor is discharged, an electric potential (restricting voltage) may exist between the terminals.
2. Electric potential between positive and negative terminal may exist as a result of returned electromotive force, so please discharge the capacitor using a 1K Ω resistor.
3. Leakage current of aluminum electrolytic capacitors may be increased during long storage time. In this case, the capacitors should be subjected to voltage treatment a 1K Ω resistor before using
4. Please confirm ratings (voltage and capacitance) and polarity before installing capacitors on the P.C. board
5. Do not drop capacitors on the floors and damage, nor use a capacitors that was dropped
6. Please confirm that lead spacing of the capacitor matches the hole spacing of the P.C. board prior to installation
7. Please pay attention that the clinch force is not too strong when capacitors are placed and fixed by an automatic insertion machine
8. Soldering
 - 1) Soldering condition (temperature and times) must be confirmed to be within Infinex specification
 - 2) Soldering Iron should never touch the capacitors body and do not dip capacitors body into melted solder
 - 3) Please avoid contact between other components and the aluminum capacitor
 - 4) Please avoid having flux adhere to any portion except the terminal
9. After Soldering
 - 1) Do not bend or twist the capacitors body after soldering on P.C Board
 - 2) Do not hit the capacitors and isolate capacitors from the P.C. board or other device when stacking P.C. boards in store
10. Standard Aluminum Electrolytic Capacitors should be from halogenated solvents during P.C. board cleaning after soldering
11. Do not use halogenated adhesives and coating materials to fix Aluminum Electrolytic Capacitor

Caution for Assembling Capacitors

1. Do not directly touch terminal by hand
2. Keep electric conductor off terminals to avoid short circuit
3. Do not use following conditions for assembling capacitors
 - (1) Damp conditions such as water, saltwater spray, or oil spray or fumes. High humidity or humidity condensation situations
 - (2) In an atmosphere filled with toxic gasses (such as hydrogen sulfide, sulfurous acid, nitrous acid, chlorine, ammonia, etc.)
 - (3) Being exposed to direct sunlight, ozone, ultraviolet ray, or Radiation
 - (4) Being exposed to acidic or alkaline solutions
 - (5) Under severe conditions where vibration and / or mechanical shock exceed the applicable ranges of the specification

Maintenance Inspection

Please periodically inspect the capacitors that are installed in industrial equipment. Remarkable abnormality such as vent operation leaking electrolyte, etc . Capacitance, dielectric loss tangent, leakage current, and items specified in the specification

Safe Precautions

1. If you see smoke due to operation of safety vent, turn off the main switch or pull out the plug from the outlet
2. Do not bring your face near the capacitor when the pressure relief vent operates, because the gases emitted from that
3. Are over 100°C. If the gas gets into your eyes, please flush your eyes immediately with pure water. If electrolyte exposed on your skin, please wash it

with soap and water.

Application Guidelines for Aluminum Electrolytic Capacitors

Storage

1. It is recommended to keep capacitors between the ambient temperatures of 5°C to 35°C and a relative humidity of 75% or below.
2. Confirm that the environment does not have any of the following conditions:
 - 1) Damp conditions such as water, saltwater spray, or oil spray or fumes. High humidity or humidity condensation situations
 - 2) In an atmosphere filled with toxic gasses (such as hydrogen sulfide, sulfurous acid, nitrous acid, chlorine, ammonia, etc.)
 - 3) Being exposed to direct sunlight, ozone, ultraviolet ray, or radiation
 - 4) Being exposed to acidic or alkaline solutions
 - 5) Under severe conditions where vibration and/or mechanical shock exceed the applicable ranges of the specification

3.

| Category | Description | Storage life |
|------------------|----------------|---|
| Mid-High Voltage | 160V and above | 2yrs; after 1yr, needs to check characteristics; if NG, needs to do aging |
| Low Voltage | 120V and below | 2yrs |

Remark: Re-aging condition depends on its own spec

Disposal

1. Make a hole the in the capacitor body or crush capacitors and incinerate them.
2. If incineration is not applicable, hand them over to a waste disposal agent and have them buried in a landfill

Special Notice

When choosing capacitors, if clients couldn't find the series or specification in catalogue and data sheet, please contact with our Sales or RD department, we are able to base on clients' needs to develop product with special functions. For further details, please refer to EAIJ RCR-2367B-Guideline of notabilia for fix for use in electronic equipment (Technical Standardization Committee on Passive Components (established in 1995, revised March 2002)

Environment Protection Policy

We are reducing environmentally harmful substances to do our capacitors in global environmental protection activities.

Product compatible with Pb-free and products with non-PVC encasing and RoHS compliance materials are available.

- RoHS compliance

Our capacitors do not use any of the materials specifically identified and restricted hazardous material under RoHS prohibited.

Pb : Lead, Cr6+ : Hexavalent chromium, Hg: Mercury, Cd: Cadmium, PBS :Polybrominated biphenyls, PBOE : Polybrominated diphenyl ethers.

PVC: Polyvinyl chloride

- PVC free capacitors

We use PET (Polyethylene Terephthalate) sleeve to instead of PVC (Polyvinyl Chloride) sleeve since 2005 January. As there is a size limitation for this counter measure, Please consult our sales representative their availability in big size capacitors.

- Pb-Free capacitors

Our Capacitors lead wire and terminal doesn't contain lead.

We follow up these conditions as rule and standards to use right materials to production capacitors for maintain earth environment everlasting for human.

Application Guidelines for Aluminum Electrolytic Capacitors

Effects of ambient temperature to life (for reference)

Because an aluminum electrolytic capacitor is essentially an electrochemical component, increase temperatures accelerate the chemical reaction producing gas within the capacitor, diffuse the gas to outside through the end seal, and consequently accelerate a gradual decrease in capacitance and a gradual increase in $\tan \delta$ and ESR, the following equation has been experimentally found to express the relationship between the temperature acceleration factor and the deterioration of the capacitor.

Where :

$$L_x = L_o \cdot K_{temp} = L_o \cdot B^{(T_o - T_x)/10}$$

$$K_{temp} = B^{(T_o - T_x)/10}$$

L_x = Life time (hour) of capacitor to be estimated

L_o = Base life time (hour) of capacitor

T_o = Maximum rated operating temperature (°C) capacitor shown in catalog

T_x = Actual ambient temperature (°C) of capacitor

B = Temperature acceleration factor (=2)

This equation is similar to Arrhenius equation that express a relationship between chemical reaction rates and temperature and called Arrhenius rule of aluminum electrolytic capacitors.

The temperature acceleration in factor (B) is approximately 2 over an ambient temperature range (T_x) from 40°C to the maximum rated operating temperature of the capacitor, and it means that the lifetime is approximately halved with every 10°C rise in ambient temperature and can be extended by using the capacitors at low temperatures.

For an ambient temperature range (T_x) 20°C to 40°C, the factor B will be close to 2, and the lifetime will be actually extended.

However, the environment where the devices are placed and their operating conditions influence ambient temperature, and in particular the ambient temperature in this range will be very inconstant. Therefore, a minimum lifetime should be estimated from the above formula by using the 40°C as T_x .

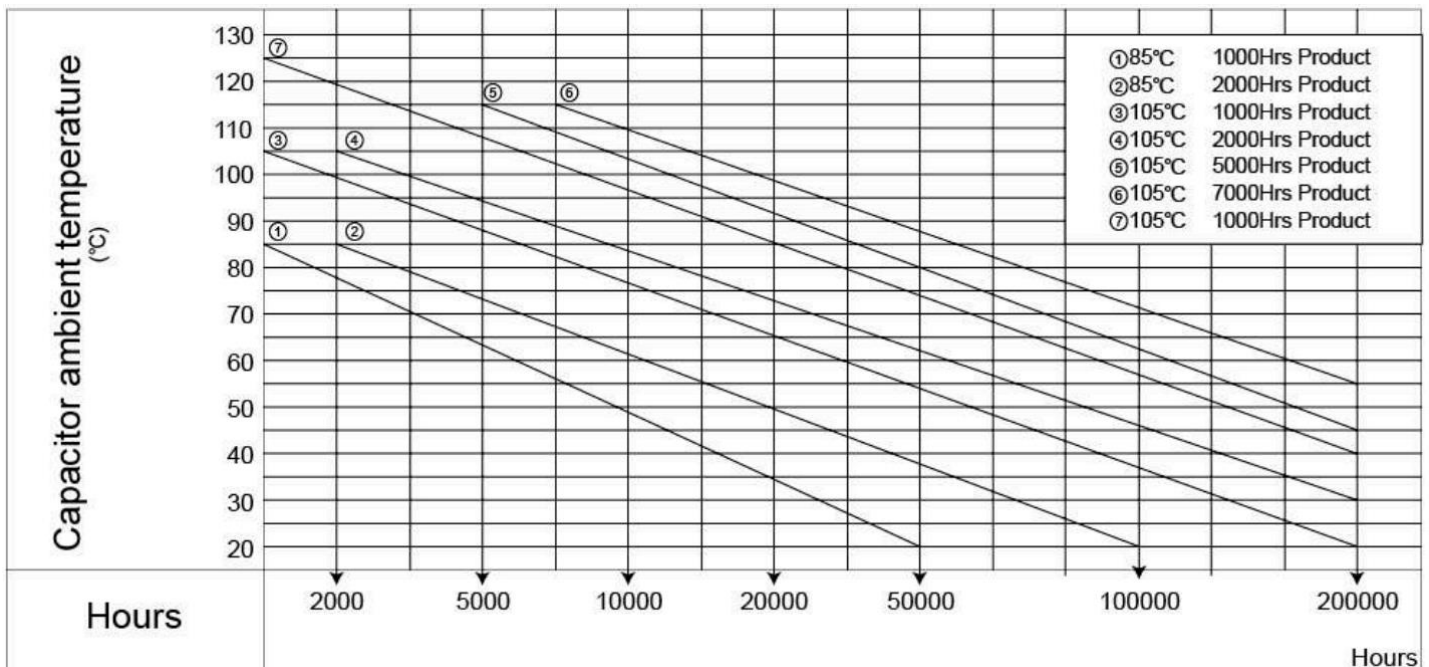

- ※ 1. A guide limit of the calculated like Aimo is 15 years max
- 2. $T_x \geq 40^\circ\text{C}$

Application Guidelines for Aluminum Electrolytic Capacitors

RECOMMENDED PB-FREE REFLOW SOLDERING CONDITIONS

The following conditions are recommended for air or infrared reflow soldering of the surface mount capacitors onto a glass epoxy circuit board of 95 x 50 x 0.8mm (with resist) by cream solder (eutectic solder). The temperatures shown are the surface temperature values of the top of the capacitor.

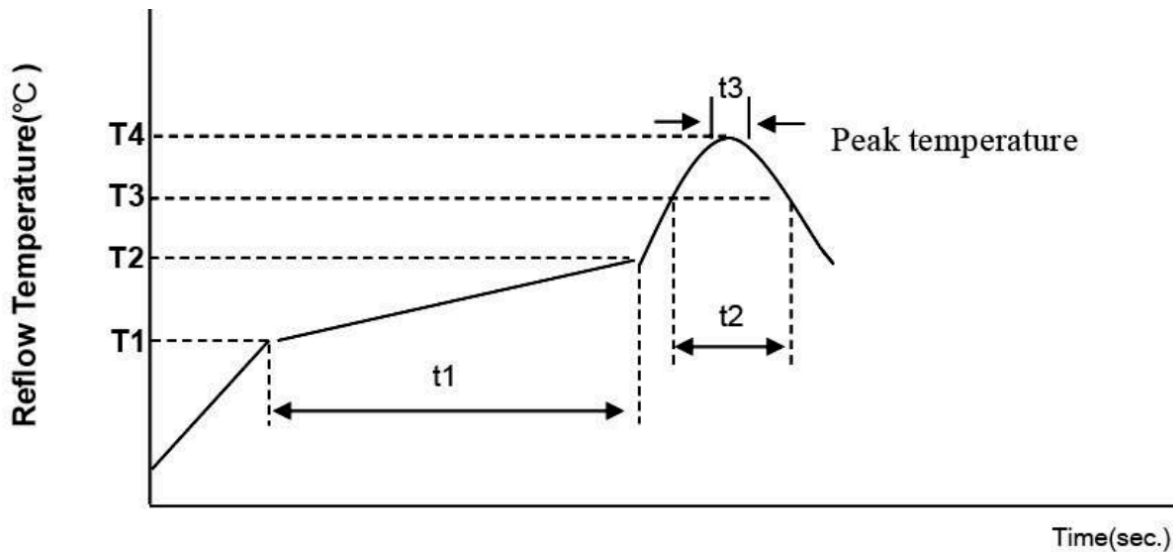

| Profile feature | Pb Free Assembly | |
|--------------------------|------------------|-----------------|
| | 4~6.3 ϕ | 8~180 ϕ |
| Average Ramp-up Rate | 3°C/second max. | 3°C/second max. |
| Preheat | | |
| Temperature Min (T1 min) | 150°C | 150°C |
| Temperature Max (T2 max) | 180°C | 180°C |
| Time (t1 Max) | 120sec. | 120sec. |
| Ramp-up Rate (T2 - T3) | 3°C/second max. | 3°C/second max. |
| Time maintained above | | |
| Temperature(T3) | 217°C | 217°C |
| Time (t2 Max) | 90sec. | 40sec. |
| Peak Temperature(T4) | 260°C | 245°C |
| Time (t3 Max) | 5sec. | 5sec. |
| Reflow Cycles | 1 | 2 or less |

Application Guidelines for Aluminum Electrolytic Capacitors

RECOMMENDED LAND PATTEND DIMENSION OF PCB

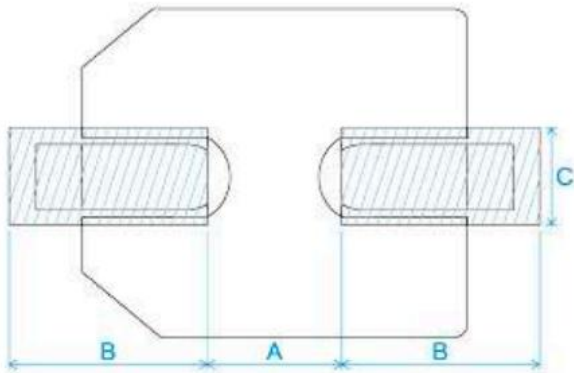

| DxL | a | b | c |
|----------|-----|-----|-----|
| Φ4 | 1.0 | 2.6 | 1.6 |
| Φ5 | 1.4 | 3.0 | 1.6 |
| Φ6.3 | 1.9 | 3.5 | 1.6 |
| Φ8 | 3.0 | 3.5 | 2.5 |
| Φ10 | 4.0 | 4.0 | 2.5 |
| Φ12.5 | 4.3 | 5.8 | 2.5 |
| Φ16 | 6.6 | 6.5 | 5.0 |
| Φ18 | 6.6 | 7.7 | 5.0 |
| Φ8(G) | 2.5 | 4.5 | 4.7 |
| Φ10(G) | 3.8 | 4.8 | 4.7 |
| Φ12.5(G) | 3.8 | 6.1 | 6.9 |
| Φ16(G) | 5.0 | 8.0 | 9.5 |
| Φ18(G) | 5.0 | 8.6 | 9.5 |

“(G)” “Anti-vibration Structure”.

Application Guidelines for Aluminum Electrolytic Capacitors

PRECAUTIONS FOR USERS

Soldering method

The capacitors of Alchip-series have no capability to withstand such dip or wave soldering as totally immerses components into a solder bath.

Reflow soldering

Reflow the capacitors within recommended reflow soldering conditions. Verify no temperature stress to the capacitors because the following differences might degrade capacitors electrically and mechanically. Please consult us if other reflow conditions are employed.

1. Location of components: Temperature increases at the edge of PC board more than the center.
2. Population of PC board: The less the component population is the more temperature rises.
3. Material of PC board: A ceramic made board needs more heat than a glass epoxy made board. The heat increase may cause damage of the capacitors.
4. Thickness of PC board: A thicker board needs more heat than a thinner board. The heat increase may damage the capacitors.
5. Size of PC board: A larger board needs more heat than a smaller board. The heat increase may damage the capacitors.
6. Location of infrared ray lamps: IR reflow as well as hot plate reflow applies heat only on the reverse side of the PC board to lessen heat stress to the capacitors.
7. Vapor heat transfer systems (VPS) are not recommended.

Rework of soldering

Avoid reflow soldering more than once. Use a soldering iron for rework. Do not exceed an iron tip temperature of $380 \pm 10^\circ\text{C}$ and an exposure time of 3 ± 0.5 seconds.

Mechanical stress

Do not use the capacitors for lifting the PC board and give stress to the capacitor. Avoid bending the PC board. These may damage the capacitors.

Cleaning assembly board

Immediately after solvent cleaning, remove residual solvent for at least 10 minutes with an air knife. The solvent is so insufficiently dry for a long period of time that the capacitors may be cored.

Coating on assembly board

1. Before curing coating material remove the cleaning solvents from the assembly board.
2. Before conformal coating, a chloride free pre-coat material is recommended to use for lessening stress to the capacitors.

Molding with resin

Internal chemical reaction gradually produces gas in the capacitor; then, internal pressure is increasing. If the end seal of the capacitor is completely molded with a resin. The gas stays inside the capacitor. It will face dangerous situation. The chlorine contained resin will penetrate into the end seal, reach the inside element, and cause damage of the capacitor.

Others

Precautions and Guidelines for Aluminum Electrolytic Capacitors shall be referred.

ATA Series

- Anhydrous product.
- Low impedance at High frequency range, high ripple current resistance.
- Suitable for return-circuit of switching power source.
- RoHS Compliant & Halogen Free.

Specifications

| Items | Characteristics | | | | | | | | | | | |
|--|---|---|------|------|------|------|--------------|------|------|-----------|-----------|------|
| Capacitance Tolerance | ± 20% (120Hz, 20°C) | | | | | | | | | | | |
| Operating Temperature Range | -55 ~ +105°C | | | | | | -40 ~ +105°C | | | | | |
| Rated Voltage Range | 6.3 ~ 100VDC | | | | | | 160 ~ 400VDC | | | | | |
| Leakage Current | $V \leq 100V$ $I \leq 0.01CV$ or 3 (μA) (After 2 minutes application of DC rated voltage, at 20°C) $V > 100V$ $I \leq 0.03CV + 20$ (μA) (After 5 minutes application of DC rated voltage, at 20°C) | | | | | | | | | | | |
| Dissipation Factor | Measurement Frequency: 120Hz. Temperature: 20°C | | | | | | | | | | | |
| | Rated Voltage (V) | 6.3 | 10 | 16 | 25 | 35 | 50 | 63 | 80 | 100 | 160 ~ 250 | 400 |
| | tan δ(Max) | 0.22 | 0.19 | 0.16 | 0.14 | 0.12 | 0.10 | 0.08 | 0.08 | 0.07 | 0.20 | 0.24 |
| When nominal capacitance over 1000μF, tan δ shall be added 0.02 to the listed value with increase of every 1000μF. | | | | | | | | | | | | |
| Low Temperature Stability Impedance Ratio (Max) | Measurement Frequency: 120Hz. | | | | | | | | | | | |
| | Rated Voltage(V) | 6.3 | 10 | 16 | 25 | 35 | 50 | 63 | 100 | 160 ~ 250 | 400 | |
| | Z(-25°C)/Z(20°C) | 4 | 3 | 2 | 2 | 2 | 2 | 2 | 2 | 3 | 6 | |
| | Z(-40°C)/Z(20°C) | - | - | - | - | - | - | 3 | 3 | 6 | 12 | |
| Z(-55°C)/Z(20°C) | 8 | 6 | 4 | 3 | 3 | 3 | - | - | - | - | | |
| Load Life | 2000 hours, with application of rated voltage at 105°C | | | | | | | | | | | |
| | Capacitance Change | Within ± 20% of Initial Value | | | | | | | | | | |
| | tan δ | 200% or less of Initial Specified Value | | | | | | | | | | |
| | Leakage Current | Initial Specified Value or less | | | | | | | | | | |
| Shelf Life | The following specifications shall be satisfied when the capacitors are restored to 20°C after exposing them for 1,000 hours 105°C without voltage applied. Before the measurement, the capacitor shall be preconditioned by applying voltage according to them 4.1 of JIS C5101-4. | | | | | | | | | | | |
| | Capacitance Change | Within ± 20% of Initial Value | | | | | | | | | | |
| | tan δ | 200% or less of Initial Specified Value | | | | | | | | | | |
| | Leakage Current | Initial Specified Value or less | | | | | | | | | | |
| Standards | JIS C-5101-4(IEC 60384) | | | | | | | | | | | |

Frequency Coefficient for Ripple Current

| Rated Voltage (V) | Capacitance (μF) | Frequency (Hz) | | | | |
|-------------------|------------------|----------------|------|------|------|------|
| | | 50 | 120 | 1K | 10K | 100K |
| 6.3 ~ 100 | 47 ~ 100 | 0.45 | 0.55 | 0.75 | 0.90 | 1.00 |
| | 220 ~ 1000 | 0.60 | 0.70 | 0.85 | 0.95 | 1.00 |
| | 1500 ~ 15000 | 0.70 | 0.80 | 0.95 | 0.98 | 1.00 |
| 160 ~ 400 | 2.2 ~ 330 | 0.55 | 0.65 | 0.80 | 0.90 | 1.00 |

The endurance of capacitors is reduced with internal heating produced by ripple current at the rate of halving the lifetime with every 5°C rise. When long life performance is required in actual use, the RMS ripple current has to be reduced.

ATA Series

Dimensions (mm)

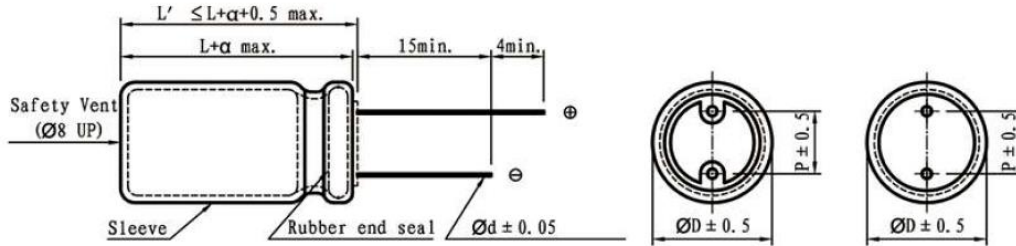

Standard Ratings

DxL (mm); R.C. (mA rms) at 105°C 100KHz; IMP (Ω max) at 20°C 100KHz

| Cap (μ F) | V | 6.3 | | | 10 | | | 16 | | | 25 | | |
|----------------|---|--------|-------|-------|--------|-------|-------|--------|-------|-------|--------|-------|-------|
| | | Item | D x L | R.C. | IMP | D x L | R.C. | IMP | D x L | R.C. | IMP | D x L | R.C. |
| 4.7 | | | | | | | | | | | 05x11 | 50 | 1.820 |
| 10 | | | | | | | | | | | 05x11 | 80 | 1.820 |
| 22 | | | | | | | | | | | 05x11 | 110 | 0.970 |
| 47 | | | | | 05x11 | 140 | 0.860 | 05x11 | 170 | 0.790 | 05x11 | 170 | 0.790 |
| 68 | | | | | 05x11 | 160 | 0.860 | 05x11 | 210 | 0.670 | 6.3x11 | 210 | 0.670 |
| 100 | | | | | 05x11 | 180 | 0.860 | 6.3x11 | 270 | 0.360 | 6.3x11 | 270 | 0.360 |
| 220 | | 6.3x11 | 270 | 0.430 | 6.3x11 | 270 | 0.400 | 08x12 | 440 | 0.240 | 08x12 | 440 | 0.240 |
| 330 | | 6.3x11 | 320 | 0.410 | 08x12 | 440 | 0.260 | 08x12 | 440 | 0.240 | 10x13 | 650 | 0.120 |
| 470 | | 8x12 | 440 | 0.290 | 08x12 | 440 | 0.260 | 10x13 | 650 | 0.120 | 10x16 | 800 | 0.091 |
| 680 | | 8x12 | 440 | 0.290 | 10x13 | 650 | 0.130 | 10x16 | 800 | 0.091 | 10x20 | 1050 | 0.070 |
| 1000 | | 10x13 | 650 | 0.140 | 10x16 | 800 | 0.098 | 10x20 | 1050 | 0.070 | 13x21 | 1350 | 0.067 |
| 1500 | | 10x16 | 800 | 0.100 | 10x20 | 1050 | 0.077 | 13x21 | 1350 | 0.067 | 13x25 | 1650 | 0.048 |
| 2200 | | 10x25 | 1350 | 0.079 | 13x21 | 1350 | 0.073 | 13x25 | 1650 | 0.052 | 16x26 | 2050 | 0.036 |
| 3300 | | 13x21 | 1350 | 0.079 | 13x25 | 1650 | 0.065 | 16x26 | 2050 | 0.036 | 16x32 | 2550 | 0.033 |
| 4700 | | 13x25 | 1650 | 0.051 | 13x35 | 2050 | 0.040 | 16x32 | 2550 | 0.033 | 18x35 | 2950 | 0.031 |
| 6800 | | 16x26 | 2050 | 0.043 | 16x32 | 2550 | 0.036 | 18x35 | 2950 | 0.031 | 18x40 | 3300 | 0.028 |
| 10000 | | 16x32 | 2550 | 0.039 | 18x35 | 2950 | 0.034 | 18x40 | 3300 | 0.028 | | | |
| 15000 | | 16x35 | 2950 | 0.036 | 18x40 | 3300 | 0.030 | | | | | | |

※13mm may be replaced by 12.5mm upon customer's request.

ATA Series

Standard Ratings

D×L (mm); R.C.(mA rms) at 105°C 100KHz; IMP(Ω max) at 20°C 100KHz

| Cap (μF) | V | 35 | | | 50 | | | 63 | | | 100 | | |
|----------|------|--------|------|-------|--------|------|--------|--------|------|-------|--------|------|-------|
| | Item | D x L | R.C. | IMP | D x L | R.C. | IMP | D x L | R.C. | IMP | D x L | R.C. | IMP |
| 0.47 | | | | | 5x11 | 25 | 10.730 | | | | 5x11 | 20 | 30.30 |
| 1 | | | | | 5x11 | 40 | 7.580 | | | | 5x11 | 30 | 28.60 |
| 2.2 | | | | | 5x11 | 55 | 6.440 | | | | 5x11 | 44 | 14.00 |
| 3.3 | | | | | 5x11 | 65 | 5.580 | | | | 5x11 | 58 | 9.400 |
| 4.7 | | 5x11 | 85 | 2.640 | 5x11 | 90 | 3.290 | 5x11 | 65 | 9.880 | 5x11 | 74 | 6.600 |
| 10 | | 5x11 | 100 | 1.580 | 5x11 | 110 | 2.000 | 5x11 | 110 | 5.450 | 6.3x11 | 130 | 2.600 |
| 22 | | 5x11 | 120 | 1.320 | 5x11 | 140 | 1.720 | 6.3x11 | 200 | 1.890 | 8x12 | 230 | 2.000 |
| 33 | | 5x11 | 210 | 0.568 | 6.3x11 | 240 | 0.690 | 6.3x11 | 250 | 1.770 | 10x13 | 320 | 0.700 |
| 47 | | 6.3x11 | 270 | 0.550 | 6.3x11 | 240 | 0.690 | 8x12 | 320 | 0.800 | 10x16 | 390 | 0.500 |
| 68 | | 8x12 | 360 | 0.396 | 8x12 | 300 | 0.430 | 10x13 | 380 | 0.760 | 10x20 | 420 | 0.400 |
| 100 | | 8x12 | 440 | 0.246 | 8x12 | 400 | 0.360 | 10x13 | 450 | 0.670 | 13x21 | 580 | 0.300 |
| 220 | | 10x13 | 650 | 0.132 | 10x16 | 600 | 0.240 | 10x20 | 780 | 0.340 | 16x26 | 880 | 0.100 |
| 330 | | 10x16 | 800 | 0.100 | 10x20 | 800 | 0.220 | 13x21 | 950 | 0.210 | 16x32 | 930 | 0.100 |
| 470 | | 10x20 | 1050 | 0.077 | 13x21 | 1050 | 0.130 | 13x25 | 1430 | 0.170 | 16x36 | 1230 | 0.100 |
| 680 | | 13x21 | 1350 | 0.073 | 13x25 | 1150 | 0.100 | 16x26 | 1780 | 0.130 | 18x35 | 1410 | 0.091 |
| 1000 | | 13x25 | 1650 | 0.056 | 16x26 | 1550 | 0.069 | 16x32 | 1900 | 0.100 | 18x40 | 1520 | 0.065 |
| 1500 | | 16x26 | 2050 | 0.040 | 16x32 | 1950 | 0.061 | 18x35 | 2150 | 0.079 | | | |
| 2200 | | 16x32 | 2550 | 0.036 | 18x35 | 2250 | 0.057 | 18x40 | 2350 | 0.077 | | | |
| 3300 | | 18x35 | 2950 | 0.034 | | | | | | | | | |
| 4700 | | 18x40 | 3300 | 0.030 | | | | | | | | | |

※13mm may be replaced by 12.5mm upon customer's request.

Standard Ratings

D×L (mm); R.C.(mA rms) at 105°C 100KHz

| Cap (μF) | V | 160 | | 200 | | 250 | | 400 | |
|----------|------|-------|------|-------|------|-------|------|-------|------|
| | Item | D x L | R.C. | D x L | R.C. | D x L | R.C. | D x L | R.C. |
| 2.2 | | | | | | 8x12 | 105 | 8x12 | 80 |
| 3.3 | | 8x12 | 104 | 8x12 | 113 | 8x12 | 122 | 10x13 | 110 |
| 4.7 | | 8x12 | 112 | 8x12 | 126 | 10x13 | 140 | 10x16 | 160 |
| 10 | | 10x13 | 180 | 10x13 | 210 | 10x16 | 300 | 10x20 | 195 |
| 22 | | 10x16 | 250 | 10x20 | 465 | 13x21 | 485 | 13x25 | 350 |
| 33 | | 10x20 | 570 | 10x25 | 600 | 13x21 | 620 | 13x25 | 580 |
| 47 | | 13x21 | 730 | 13x21 | 730 | 13x25 | 810 | 16x26 | 720 |
| 68 | | 13x25 | 850 | 13x25 | 985 | 16x26 | 1010 | 16x32 | 820 |
| 100 | | 16x26 | 1285 | 16x26 | 1285 | 16x32 | 1405 | 18x35 | 950 |
| 150 | | 16x32 | 1310 | 16x32 | 1310 | 18x32 | 1455 | | |
| 220 | | 16x36 | 1450 | 18x32 | 1510 | 18x40 | 1490 | | |
| 330 | | 18x35 | 1850 | | | | | | |

※13mm may be replaced by 12.5mm upon customer's request.

ATB Series

- Anhydrous product.
- Low impedance at High frequency range.
- High ripple current resistance, 105°C 4000~8000 hours long life.
- RoHS Compliant & Halogen Free

Specifications

| Items | Characteristics | | | | | | | | |
|--|---|---|-------|-------|--------------|-------|-------|-------|-------|
| Capacitance Tolerance | ± 20% (120Hz, 20°C) | | | | | | | | |
| Operating Temperature Range | -55 ~ +105°C | | | | -40 ~ +105°C | | | | |
| Rated Voltage Range | 6.3 ~ 50VDC | | | | 63 ~ 100VDC | | | | |
| Leakage Current | $I \leq 0.01CV$ or 3 (μA) which is greater. (After 2 minutes application of DC rated voltage, at 20°C) | | | | | | | | |
| Dissipation Factor | Rated Voltage(V) | 6.3 | 10 | 16 | 25 | 35 | 50 | 63~80 | 100 |
| | tan δ(Max) | 0.24 | 0.20 | 0.16 | 0.15 | 0.12 | 0.10 | 0.09 | 0.08 |
| When nominal capacitance over 1000μF, tan δ shall be added 0.02 to the listed value with increase of every 1000μF. | | | | | | | | | |
| Low Temperature Stability Impedance Ratio (Max) | Measurement Frequency: 120Hz. | | | | | | | | |
| | Rated Voltage(V) | 6.3 | 10 | 16 | 25 | 35 | 50 | 63 | 100 |
| | Z(-25°C)/Z(20°C) | 4 | 3 | 2 | 2 | 2 | 2 | 2 | 2 |
| | Z(-40°C)/Z(20°C) | - | - | - | - | - | - | 3 | 3 |
| | Z(-55°C)/Z(20°C) | 8 | 6 | 4 | 3 | 3 | 3 | - | - |
| Load Life | Time | ∅ | 5 | 6.3 | 8 | 10 | 13 | 16 | 18 |
| | | hours | 4,000 | 4,000 | 5,000 | 6,000 | 7,000 | 8,000 | 8,000 |
| | Capacitance Change | within ± 25% of the Initial Value | | | | | | | |
| | tan δ | 200% or less of the Initial Specified Value | | | | | | | |
| | Leakage Current | Initial Specified Value or less | | | | | | | |
| Shelf Life | The following specifications shall be satisfied when the capacitors are restored to 20°C after exposing them for 1,000 hours 105°C without voltage applied. Before the measurement, the capacitor shall be preconditioned by applying voltage according to them 4.1 of JIS C5101-4. | | | | | | | | |
| | Capacitance Change | within ± 25% of the Initial Value | | | | | | | |
| | tan δ | 200% or less of the Initial Specified Value | | | | | | | |
| | Leakage Current | Initial Specified Value or less | | | | | | | |
| Standards | JIS C-5101-4(IEC 60384) | | | | | | | | |

Frequency Coefficient for Ripple Current

| Capacitance (μF) | Frequency (Hz) | | | |
|------------------|----------------|------|------|------|
| | 120 | 1K | 10K | 100K |
| 5.6 ~ 180 | 0.40 | 0.75 | 0.90 | 1.00 |
| 220 ~ 560 | 0.50 | 0.85 | 0.94 | 1.00 |
| 680 ~ 1800 | 0.60 | 0.87 | 0.95 | 1.00 |
| 2200 ~ 3900 | 0.75 | 0.90 | 0.95 | 1.00 |
| 4700 ~ 18000 | 0.85 | 0.95 | 0.98 | 1.00 |

The endurance of capacitors is reduced with internal heating produced by ripple current at the rate of halving the lifetime with every 5°C rise. When long life performance is required in actual use, the RMS ripple current has to be reduced.

ATB Series

Dimensions (mm)

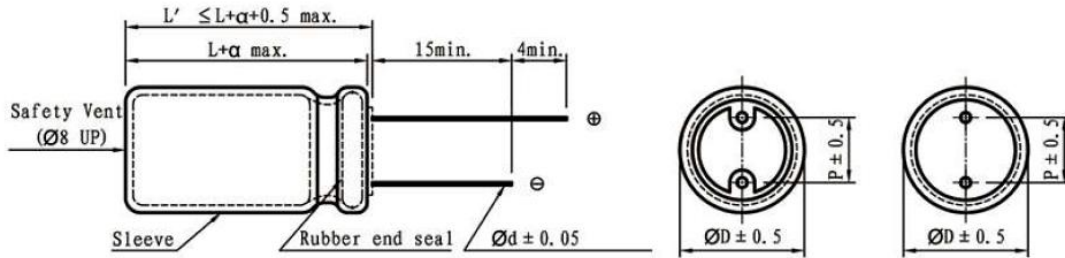

| | | | | | | | |
|-----|-----|-----|-----|-----|-----|-----|-----|
| Ø D | 5 | 6.3 | 8 | 10 | 13 | 16 | 18 |
| P | 2.0 | 2.5 | 3.5 | 5.0 | 5.0 | 7.5 | 7.5 |
| Ø d | 0.5 | 0.5 | 0.5 | 0.6 | 0.6 | 0.8 | 0.8 |

| | |
|---|--------------|
| α | (L < 16) 1.0 |
| | (L ≥ 16) 2.0 |

Standard Ratings

DxL (mm), R.C. (mA rms) at 105°C 100KHz; IMP (Ω max) at 20°C, -10°C 100KHz.

| Cap (µF) | V | 6.3 | | | | 10 | | | | 16 | | | | 25 | | | | |
|----------|---|--------|-------|-------|-------|--------|-------|-------|-------|--------|-------|-------|-------|--------|-------|-------|-------|------|
| | | Item | D x L | IMP | | R.C. | D x L | IMP | | R.C. | D x L | IMP | | R.C. | D x L | IMP | | R.C. |
| | | | | 20°C | -10°C | | | 20°C | -10°C | | | 20°C | -10°C | | | 20°C | -10°C | |
| 47 | | | | | | | | | | 5x11 | 0.550 | 1.100 | 170 | 5x11 | 0.600 | 1.210 | 175 | |
| 100 | | | | | | 5x11 | 0.550 | 1.100 | 170 | 6.3x11 | 0.290 | 0.550 | 295 | 6.3x11 | 0.310 | 0.610 | 295 | |
| 150 | | 5x11 | 0.550 | 1.100 | 170 | | | | | 6.3x15 | 0.190 | 0.400 | 410 | 6.3x15 | 0.220 | 0.430 | 420 | |
| 220 | | | | | | 6.3x11 | 0.270 | 0.550 | 295 | 6.3x15 | 0.190 | 0.400 | 410 | 8x12 | 0.150 | 0.290 | 650 | |
| 330 | | 6.3x11 | 0.270 | 0.550 | 295 | 6.3x15 | 0.200 | 0.390 | 400 | 8x12 | 0.140 | 0.260 | 660 | 8x16 | 0.110 | 0.220 | 750 | |
| 390 | | | | | | | | | | | | | | 10x13 | 0.110 | 0.220 | 770 | |
| 470 | | 6.3x15 | 0.200 | 0.400 | 400 | 8x12 | 0.140 | 0.260 | 650 | 8x20 | 0.091 | 0.180 | 830 | 8x20 | 0.096 | 0.180 | 820 | |
| 560 | | | | | | | | | | 8x16 | 0.100 | 0.200 | 740 | 10x16 | 0.085 | 0.170 | 1060 | |
| 680 | | | | | | 8x16 | 0.100 | 0.200 | 830 | 10x13 | 0.100 | 0.200 | 770 | | | | | |
| 820 | | 10x13 | 0.100 | 0.200 | 860 | 10x13 | 0.100 | 0.200 | 860 | 8x20 | 0.077 | 0.150 | 1070 | 10x20 | 0.067 | 0.130 | 1230 | |
| 1000 | | 8x16 | 0.100 | 0.210 | 830 | 8x20 | 0.091 | 0.170 | 1010 | 10x16 | 0.077 | 0.150 | 1250 | 10x20 | 0.061 | 0.120 | 1270 | |
| 1200 | | | | | | 10x16 | 0.077 | 0.150 | 1250 | 10x20 | 0.061 | 0.120 | 1420 | 10x20 | 0.053 | 0.100 | 1450 | |
| 1500 | | 8x20 | 0.094 | 0.190 | 1060 | 10x20 | 0.061 | 0.120 | 1420 | 10x25 | 0.053 | 0.100 | 1450 | 10x25 | 0.053 | 0.100 | 1450 | |
| 1800 | | 10x16 | 0.077 | 0.150 | 1250 | 10x20 | 0.061 | 0.120 | 1420 | 10x30 | 0.043 | 0.085 | 1700 | 13x21 | 0.048 | 0.097 | 1670 | |
| 2200 | | | | | | 10x20 | 0.059 | 0.120 | 1420 | 13x21 | 0.045 | 0.087 | 1670 | 10x25 | 0.052 | 0.100 | 1640 | |
| 2700 | | 10x30 | 0.045 | 0.086 | 1930 | 13x21 | 0.045 | 0.088 | 1650 | 13x25 | 0.036 | 0.069 | 1970 | 13x25 | 0.036 | 0.069 | 1960 | |
| 3300 | | 13x21 | 0.044 | 0.086 | 1650 | 13x25 | 0.036 | 0.069 | 1960 | 13x30 | 0.030 | 0.058 | 2330 | 13x30 | 0.030 | 0.058 | 2330 | |
| 3900 | | 13x25 | 0.036 | 0.069 | 1960 | 13x30 | 0.030 | 0.058 | 2320 | 13x35 | 0.028 | 0.051 | 2520 | 13x35 | 0.028 | 0.051 | 2520 | |
| 4700 | | 13x30 | 0.030 | 0.058 | 2320 | 13x35 | 0.025 | 0.052 | 2520 | 16x26 | 0.028 | 0.051 | 2570 | 16x26 | 0.025 | 0.051 | 2570 | |
| 5600 | | 13x35 | 0.026 | 0.051 | 2520 | 16x32 | 0.022 | 0.041 | 2880 | 16x32 | 0.023 | 0.045 | 3020 | 16x32 | 0.022 | 0.041 | 3160 | |
| 6300 | | | | | | 18x25 | 0.025 | 0.047 | 2750 | 16x36 | 0.022 | 0.041 | 3160 | 18x25 | 0.023 | 0.047 | 2750 | |
| 6800 | | 13x40 | 0.022 | 0.041 | 2880 | 16x36 | 0.022 | 0.041 | 3150 | 18x25 | 0.025 | 0.047 | 2750 | 16x36 | 0.020 | 0.040 | 3140 | |
| 8200 | | 16x26 | 0.028 | 0.051 | 2570 | 18x32 | 0.022 | 0.043 | 3340 | 18x32 | 0.022 | 0.043 | 3340 | 18x32 | 0.021 | 0.039 | 3670 | |
| 10000 | | 16x32 | 0.024 | 0.045 | 3020 | 18x32 | 0.022 | 0.043 | 3340 | 18x35 | 0.021 | 0.037 | 3670 | 18x35 | 0.021 | 0.037 | 3670 | |
| 12000 | | 16x36 | 0.021 | 0.040 | 3150 | 18x35 | 0.021 | 0.037 | 3670 | 18x40 | 0.020 | 0.036 | 3810 | 18x40 | 0.020 | 0.036 | 3810 | |
| 15000 | | 18x25 | 0.025 | 0.047 | 2750 | 18x40 | 0.020 | 0.036 | 3810 | | | | | | | | | |
| 18000 | | 16x40 | 0.020 | 0.036 | 3720 | | | | | | | | | | | | | |
| | | 18x32 | 0.022 | 0.042 | 3340 | | | | | | | | | | | | | |
| | | 18x35 | 0.021 | 0.037 | 3670 | | | | | | | | | | | | | |
| | | 18x40 | 0.020 | 0.036 | 3810 | | | | | | | | | | | | | |

ATC Series

- Anhydrous product.
- High ripple current, ultra-low impedance at high frequency range.
- Long life.
- RoHS Compliant

Specifications

| Items | Characteristics | | | | | | | |
|---|---|---|----|------|-----|----|------|--------|
| Capacitance Tolerance | ± 20% (120Hz, 20°C) | | | | | | | |
| Operating Temperature Range | -55 ~ +105°C | | | | | | | |
| Rated Voltage Range | 6.3 ~ 50VDC | | | | | | | |
| Leakage Current | $I \leq 0.01CV$ or 3 (μA) which is greater. (After 2 minutes application of DC rated voltage, at 20°C) | | | | | | | |
| Dissipation Factor | Measurement Frequency: 120Hz. Temperature: 20°C | | | | | | | |
| | Rated Voltage (V) | 6.3 | 10 | 16 | 25 | 35 | 50 | 63~100 |
| | tan δ(Max) | 0.24 | 0. | 0.16 | 0.1 | 0. | 0.10 | 0.09 |
| | When nominal capacitance over 1000μF, tan δ shall be added 0.02 to the listed value with increase of every 1000μF. | | | | | | | |
| Low Temperature Stability Impedance Ratio (Max) | Measurement Frequency: 120Hz. | | | | | | | |
| | Rated Voltage(V) | 6.3 | 10 | 16 | 25 | 35 | 50 | |
| | Z(-25°C)/Z(20°C) | 2 | 2 | 2 | 2 | 2 | 2 | |
| | Z(-55°C)/Z(20°C) | 3 | 3 | 3 | 3 | 3 | 3 | |
| Load Life | 5,000 hours, with application of rated voltage at 105°C (∅D ≤ 6.3mm, 2,000 hours ; ∅D = 8mm, 3,000 hours ; ∅D = 10mm, 4,000 hours) | | | | | | | |
| | Capacitance Change | Within ± 25% of Initial Value | | | | | | |
| | tan δ | 200% or less of Initial Specified Value | | | | | | |
| | Leakage Current | Initial Specified Value or less | | | | | | |
| Shelf Life | The following specifications shall be satisfied when the capacitors are restored to 20°C after exposing them for 1,000 hours 105°C without voltage applied. Before the measurement, the capacitor shall be preconditioned by applying voltage according to them 4.1 of JIS C5101-4. | | | | | | | |
| | Capacitance Change | Within ± 20% of Initial Value | | | | | | |
| | tan δ | 200% or less of Initial Specified Value | | | | | | |
| | Leakage Current | Initial Specified Value or less | | | | | | |
| Standards | JIS C-5101-4(IEC 60384) | | | | | | | |

Frequency Coefficient of Ripple Current

| Capacitance (μF) | Frequency (Hz) | | | | |
|------------------|----------------|------|------|------|------|
| | 50 | 120 | 1K | 10K | 100K |
| ≤ 33 | 0.45 | 0.55 | 0.75 | 0.90 | 1.00 |
| 47 ~ 330 | 0.60 | 0.70 | 0.85 | 0.95 | 1.00 |
| 470 ~ 1000 | 0.65 | 0.75 | 0.90 | 0.98 | 1.00 |
| 1200 ~ 6800 | 0.75 | 0.80 | 0.95 | 1.00 | 1.00 |

The endurance of capacitors is reduced with internal heating produced by ripple current at the rate of halving the lifetime with every 5°C rise. When long life performance is required in actual use, the RMS ripple current has to be reduced.

ATC Series

Dimensions (mm)

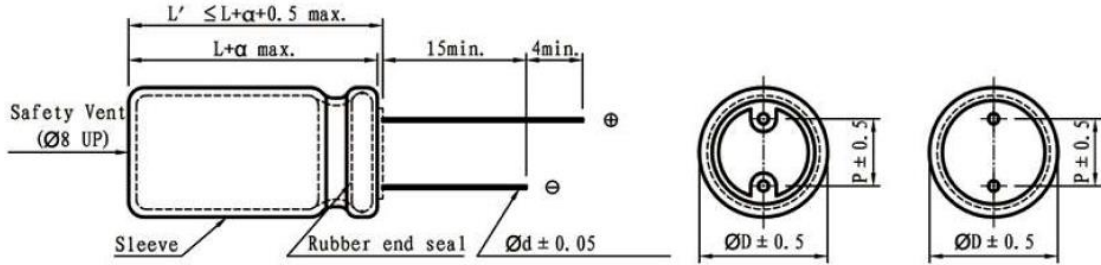

| | |
|----------|--------------|
| α | (L < 16) 1.0 |
| | (L ≥ 16) 2.0 |

Standard Ratings

DxL (mm); R.C. (mA rms) at 105°C 100KHz; IMP (Ω max) at 20°C 100KHz.

| Cap (μ F) | V | 6.3 | | | 10 | | | 16 | | |
|----------------|---|--------|-------|-------|--------|-------|-------|--------|-------|-------|
| | | Item | D x L | R.C. | IMP | D x L | R.C. | IMP | D x L | R.C. |
| 56 | | | | | | | | 5x11 | 250 | 0.500 |
| 100 | | | | | 5x11 | 250 | 0.500 | | | |
| 120 | | | | | | | | 6.3x11 | 405 | 0.210 |
| 150 | | 5x11 | 250 | 0.845 | | | | | | |
| 220 | | | | | 6.3x11 | 405 | 0.380 | 8x12 | 700 | 0.210 |
| 330 | | 6.3x11 | 405 | 0.230 | | | | 8x12 | 760 | 0.120 |
| 470 | | | | | 8x12 | 760 | 0.210 | 8x16 | 995 | 0.093 |
| 560 | | 8x12 | 760 | 0.130 | | | | 10x13 | 1030 | 0.087 |
| 680 | | | | | 8x16 | 995 | 0.093 | 8x20 | 1250 | 0.068 |
| 820 | | | | | 10x13 | 1030 | 0.087 | 10x16 | 1430 | 0.062 |
| 820 | | 08x16 | 995 | 0.099 | | | | | | |
| 1000 | | | | | 08x20 | 1250 | 0.068 | | | |
| 1000 | | 10x13 | 1030 | 0.093 | 10x16 | 1430 | 0.062 | 10x20 | 1820 | 0.038 |
| 1200 | | | | | | | | | | |
| 1200 | | 8x20 | 1250 | 0.072 | | | | | | |
| 1200 | | 10x16 | 1430 | 0.066 | 10x20 | 1820 | 0.038 | 10x25 | 2150 | 0.036 |
| 1500 | | | | | 10x20 | 1820 | 0.040 | 10x25 | 2150 | 0.036 |
| 1500 | | 10x20 | 1820 | 0.040 | 10x25 | 2150 | 0.036 | 13x21 | 2360 | 0.035 |
| 2200 | | 10x25 | 2150 | 0.038 | 13x21 | 2360 | 0.035 | 13x25 | 2770 | 0.030 |
| 2700 | | | | | | | | 13x30 | 3140 | 0.027 |
| 3300 | | 13x21 | 2360 | 0.037 | 13x25 | 2770 | 0.030 | 13x35 | 3400 | 0.024 |
| 3900 | | 13x25 | 2770 | 0.032 | 13x30 | 3290 | 0.027 | 16x26 | 3460 | 0.026 |
| 4700 | | 13x30 | 3290 | 0.027 | 13x35 | 3400 | 0.024 | | | |
| 5600 | | 13x35 | 3140 | 0.026 | 16x26 | 3460 | 0.026 | | | |
| 6800 | | 16x26 | 3460 | 0.027 | | | | | | |

※13mm may be replaced by 12.5mm upon customer's request.

ATC Series

Standard Ratings

DxL (mm); R.C. (mA rms) at 105°C 100KHz; IMP (Ω max) at 20°C 100KHz.

| Cap (μF) | V | 25 | | | 35 | | | 50 | | |
|----------|------|---------|------|-------|--------|------|-------|--------|------|-------|
| | Item | D x L | R.C. | IMP | D x L | R.C. | IMP | D x L | R.C. | IMP |
| 22 | | | | | | | | 5x11 | 238 | 1.310 |
| 33 | | | | | 5x11 | 250 | 0.330 | | | |
| 47 | | 5x11 | 250 | 0.500 | | | | 6.3x11 | 385 | 1.140 |
| 56 | | | | | 6.3x11 | 405 | 0.230 | 6.3x11 | 385 | 0.540 |
| 68 | | | | | | | | | | |
| 100 | | 6.3x11. | 405 | 0.380 | | | | 8x12 | 724 | 0.340 |
| 120 | | | | | | | | 8x16 | 950 | 0.230 |
| 150 | | | | | 8x12 | 760 | 0.130 | 10x13 | 979 | 0.230 |
| 180 | | | | | | | | 8x20 | 1190 | 0.180 |
| 220 | | 8x12 | 760 | 0.150 | 8x16 | 995 | 0.099 | 10x16 | 1370 | 0.160 |
| | | | | | 10x13 | 1030 | 0.093 | | | |
| 270 | | | | | 8x20 | 1250 | 0.100 | 10x20 | 1580 | 0.120 |
| 330 | | 8x16 | 995 | 0.093 | 10x16 | 1430 | 0.100 | 10x25 | 1870 | 0.110 |
| | | 10x13 | 1030 | 0.087 | | | | | | |
| 470 | | 8x20 | 1250 | 0.068 | 10x20 | 1820 | 0.085 | 13x21 | 2050 | 0.110 |
| | | 10x16 | 1430 | 0.062 | | | | | | |
| 560 | | | | | 10x25 | 2150 | 0.053 | 13x25 | 2410 | 0.088 |
| 680 | | 10x20 | 1820 | 0.058 | 13x21 | 2360 | 0.051 | 13x30 | 2860 | 0.081 |
| 820 | | 10x25 | 2150 | 0.036 | 13x21 | 2450 | 0.048 | 13x35 | 2960 | 0.074 |
| 1000 | | 13x21 | 2360 | 0.035 | 13x25 | 2770 | 0.044 | 16x26 | 3010 | 0.081 |
| 1200 | | | | | 13x30 | 3140 | 0.037 | | | |
| 1500 | | 13x25 | 2770 | 0.030 | 13x35 | 3400 | 0.035 | | | |
| 1800 | | 13x30 | 3140 | 0.026 | 16x26 | 3460 | 0.037 | | | |
| 2200 | | 13x35 | 3400 | 0.024 | | | | | | |
| 2700 | | 16x26 | 3460 | 0.026 | | | | | | |

※13mm may be replaced by 12.5mm upon customer's request.

ATD Series

- Anhydrous product.
- High ripple current, Low impedance at high frequency range.
- 105°C, long life 10000hours
- RoHS Compliant.

Specifications

| Items | Characteristics | | | | | | | | |
|---|--|---|------|-------------|--------------|-------------|------|--------------|------|
| Capacitance Tolerance | ± 20% (120Hz, 20°C) | | | | | | | | |
| Operating Temperature Range | -55 ~ +105°C | | | | -40 ~ +105°C | | | | |
| Rated Voltage Range | 6.3 ~ 50VDC | | | | 63 ~ 100VDC | | | | |
| Leakage Current | I ≤ 0.01CV or 3 (μA) which is greater. (After 2 minutes application of DC rated voltage, at 20°C) | | | | | | | | |
| Dissipation Factor | Measurement Frequency: 120Hz. Temperature: 20°C | | | | | | | | |
| | Rated Voltage (V) | 6.3 | 10 | 16 | 25 | 35 | 50 | 63~80 | 100 |
| | tan δ(Max) | 0.24 | 0.20 | 0.16 | 0.15 | 0.12 | 0.10 | 0.09 | 0.08 |
| | When nominal capacitance over 1000μF, tan δ shall be added 0.02 to the listed value with increase of every 1000μF. | | | | | | | | |
| Low Temperature Stability Impedance Ratio (Max) | Measurement Frequency: 120Hz. | | | | | | | | |
| | Rated Voltage(V) | 6.3 | 10 | 16 | 25 | 35 | 50 | 63 | 100 |
| | Z(-25°C)/Z(20°C) | 4 | 3 | 2 | 2 | 2 | 2 | 2 | 2 |
| | Z(-40°C)/Z(20°C) | - | - | - | - | - | - | 3 | 3 |
| | Z(-55°C)/Z(20°C) | 8 | 6 | 4 | 3 | 3 | 3 | 3 | 3 |
| Load Life | The following specifications shall be satisfied when the capacitors are restored to 20°C after subjected to DC voltage with the rated ripple current is applied for varied hours according to varied Ø and voltage at 105°C | | | | | | | | |
| | Case Size | ØD ≤ 6.3 | | | ØD = 8, 10 | | | ØD ≥ 13 | |
| | Voltage | 6.3 ~ 10 V | | 4,000 hours | | 6,000 hours | | 8,000 hours | |
| | | 16 ~ 100 V | | 5,000 hours | | 7,000 hours | | 10,000 hours | |
| | Capacitance Change | Within ± 25% of Initial Value | | | | | | | |
| | tan δ | 200% or less of Initial Specified Value | | | | | | | |
| | Leakage Current | Initial Specified Value or less | | | | | | | |
| Shelf Life | The following specifications shall be satisfied when the capacitors are restored to 20°C after exposing them for 1,000 hours 105°C without voltage applied. Before the measurement the capacitor shall be preconditioned by applying voltage according to them 4.1 of JIS C5101-4. | | | | | | | | |
| | Capacitance Change | Within ± 25% of Initial Value | | | | | | | |
| | tan δ | 200% or less of Initial Specified Value | | | | | | | |
| | Leakage Current | Initial Specified Value or less | | | | | | | |
| Standards | JIS C-5101-4(IEC 60384) | | | | | | | | |

Frequency Coefficient for Ripple Current

| Capacitance (μF) | Frequency (Hz) | | | | |
|------------------|----------------|------|------|------|------|
| | 50 | 120 | 300 | 1K | 100K |
| ≤ 33 | 0.50 | 0.55 | 0.70 | 0.90 | 1.00 |
| 47 ~ 330 | 0.60 | 0.70 | 0.85 | 0.95 | 1.00 |
| 470 ~ 1000 | 0.65 | 0.75 | 0.90 | 0.98 | 1.00 |
| 1200 ~ 18000 | 0.70 | 0.80 | 0.95 | 1.00 | 1.00 |

The endurance of capacitors is reduced with internal heating produced by ripple current at the rate of halving the lifetime with every 5°C rise. When long life performance is required in actual use, the RMS ripple current has to be reduced.

ATD Series

Dimensions (mm)

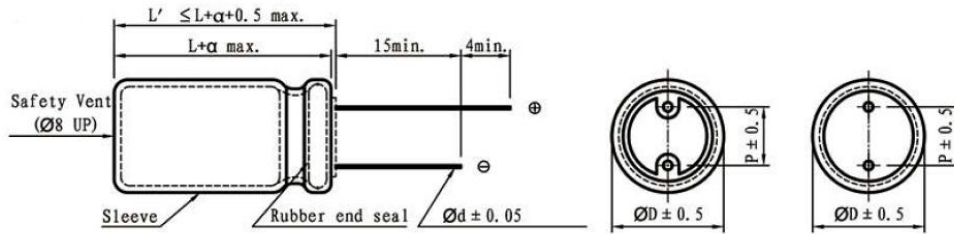

Standard Ratings

DxL (mm); R.C. (mA rms) at 105°C 100KHz; IMP (Ω max) at 20°C, -10°C 100KHz

| Cap (μ F) | V | | | | 10 | | | | |
|----------------|-------|--------|-------|-------|------|--------|-------|-------|------|
| | Item | D x L | 6.3 | | R.C. | D x L | IMP | | R.C. |
| | | | 20°C | -10°C | | | 20°C | -10°C | |
| 100 | | | | | | 5x11 | 0.640 | 2.530 | 215 |
| 150 | | 5x11 | 0.630 | 2.530 | 210 | 5x11 | 0.640 | 2.530 | 230 |
| 220 | | 6.3x11 | 0.280 | 0.990 | 320 | 6.3x11 | 0.250 | 0.960 | 340 |
| 330 | | 6.3x11 | 0.230 | 0.960 | 340 | 6.3x11 | 0.250 | 0.960 | 380 |
| 470 | | 8x12 | 0.170 | 0.640 | 345 | 8x12 | 0.150 | 0.580 | 640 |
| 680 | | 8x12 | 0.150 | 0.580 | 645 | 8x16 | 0.098 | 0.390 | 845 |
| | 10x13 | | | | | 0.091 | 0.360 | 865 | |
| 820 | | 10x13 | 0.091 | 0.360 | 865 | 10x16 | 0.080 | 0.310 | 1015 |
| 1000 | | 8x16 | 0.097 | 0.390 | 870 | 8x20 | 0.078 | 0.300 | 1050 |
| | 10x16 | | | | | 0.069 | 0.270 | 1215 | |
| 1200 | | 8x20 | 0.081 | 0.290 | 1050 | 10x20 | 0.053 | 0.200 | 1410 |
| 1500 | | 10x16 | 0.072 | 0.270 | 1215 | 10x25 | 0.048 | 0.190 | 1610 |
| 1800 | | | | | | 13x21 | 0.046 | 0.170 | 1710 |
| | 10x25 | | | | | 0.050 | 0.190 | 1650 | |
| 2200 | | 10x25 | 0.050 | 0.190 | 1650 | 10x30 | 0.036 | 0.140 | 1920 |
| 2700 | | 10x30 | 0.036 | 0.140 | 1900 | 13x21 | 0.042 | 0.140 | 1910 |
| 3300 | | 13x21 | 0.041 | 0.140 | 1900 | 13x25 | 0.032 | 0.100 | 2230 |
| 3900 | | 13x25 | 0.041 | 0.140 | 1900 | 13x30 | 0.029 | 0.089 | 2660 |
| 4700 | | 13x25 | 0.032 | 0.100 | 2240 | 13x35 | 0.025 | 0.075 | 2890 |
| 5600 | | 13x30 | 0.029 | 0.089 | 2650 | 13x40 | 0.025 | 0.064 | 3360 |
| | 16x26 | | | | | 0.025 | 0.069 | 2940 | |
| 6800 | | 13x35 | 0.025 | 0.075 | 2890 | 16x32 | 0.021 | 0.058 | 3460 |
| | | 13x40 | 0.021 | 0.064 | 3350 | 18x25 | 0.025 | 0.057 | 3150 |
| 8200 | | 16x26 | 0.025 | 0.069 | 2940 | 16x36 | 0.020 | 0.052 | 3610 |
| | | 16x32 | 0.021 | 0.058 | 3450 | 18x32 | 0.020 | 0.047 | 4180 |
| 10000 | | 16x36 | 0.021 | 0.058 | 3450 | 16x40 | 0.018 | 0.045 | 4090 |
| | | 18x25 | 0.023 | 0.057 | 3150 | 18x35 | 0.017 | 0.045 | 4150 |
| 12000 | | 16x40 | 0.017 | 0.045 | 4090 | 18x40 | 0.015 | 0.039 | 4290 |
| | | 18x32 | 0.019 | 0.047 | 4180 | | | | |
| 15000 | | 18x35 | 0.018 | 0.045 | 4230 | | | | |
| 18000 | | 18x40 | 0.016 | 0.035 | 4290 | | | | |

※ 13mm may be replaced by 12.5mm upon customer's request.

ATD Series

Standard Ratings

DxL (mm); R.C.(mA rms) at 105°C 100KHz ; IMP (Ω max) at 20°C,-10°C 100KHz.

| Cap (μF) | V | 16 | | | 25 | | | | |
|----------|-------|--------|-------|-------|------|--------|-------|-------|------|
| | | D x L | IMP | | R.C. | D x L | IMP | | R.C. |
| | | | 20°C | -10°C | | | 20°C | -10°C | |
| 47 | | | | | 5x11 | 0.760 | 3.040 | 200 | |
| 56 | | 5x11 | 0.760 | 3.040 | 220 | 5x11 | 0.760 | 3.040 | 240 |
| 100 | | 6.3x11 | 0.280 | 1.150 | 310 | 6.3x11 | 0.280 | 1.150 | 340 |
| 120 | | 6.3x11 | 0.280 | 1.150 | 340 | | | | |
| 220 | | 8x12 | 0.250 | 1.130 | 510 | 8x12 | 0.160 | 0.690 | 650 |
| 330 | | 8x12 | 0.160 | 0.690 | 650 | 8x16 | 0.120 | 0.470 | 850 |
| | 10x13 | | | | | 0.110 | 0.430 | 870 | |
| 470 | | 8x16 | 0.120 | 0.470 | 840 | 8x20 | 0.096 | 0.360 | 1050 |
| | | 10x13 | 0.110 | 0.430 | 865 | 10x16 | 0.083 | 0.320 | 1210 |
| 680 | | 8x20 | 0.095 | 0.360 | 1060 | 10x20 | 0.064 | 0.240 | 1410 |
| | | 10x16 | 0.083 | 0.320 | 1210 | | | | |
| 820 | | 10x20 | 0.073 | 0.290 | 1310 | 10x25 | 0.058 | 0.230 | 1660 |
| 1000 | | 10x20 | 0.064 | 0.240 | 1410 | 10x30 | 0.043 | 0.160 | 1920 |
| | 13x21 | | | | | 0.049 | 0.160 | 1910 | |
| 1200 | | 10x25 | 0.061 | 0.230 | 1650 | | | | |
| 1500 | | 10x30 | 0.043 | 0.160 | 1920 | 13x25 | 0.038 | 0.120 | 2240 |
| | | 13x21 | 0.050 | 0.160 | 1910 | | | | |
| 1800 | | 13x25 | 0.041 | 0.130 | 2140 | 13x30 | 0.036 | 0.110 | 2660 |
| 2200 | | 13x25 | 0.038 | 0.120 | 2240 | 13x35 | 0.030 | 0.090 | 2890 |
| 2700 | | 13x30 | 0.035 | 0.110 | 2650 | 13x40 | 0.025 | 0.078 | 3360 |
| | 16x26 | | | | | 0.031 | 0.083 | 2940 | |
| 3300 | | 13x35 | 0.030 | 0.091 | 2890 | 16x32 | 0.025 | 0.070 | 3460 |
| | 18x25 | | | | | 0.028 | 0.067 | 3150 | |
| 3900 | | 13x40 | 0.031 | 0.078 | 3350 | 18x25 | 0.023 | 0.061 | 3620 |
| | | 16x26 | 0.028 | 0.083 | 2930 | 18x32 | 0.024 | 0.056 | 4180 |
| 4700 | | 16x32 | 0.025 | 0.070 | 3450 | 16x40 | 0.020 | 0.054 | 4090 |
| | | 18x25 | 0.028 | 0.068 | 3150 | 18x35 | 0.022 | 0.054 | 4230 |
| 5600 | | 16x36 | 0.024 | 0.062 | 3620 | 18x40 | 0.018 | 0.047 | 4290 |
| | | 18x32 | 0.024 | 0.056 | 4180 | | | | |
| 6800 | | 16x40 | 0.020 | 0.054 | 4080 | | | | |
| 8200 | | 18x35 | 0.023 | 0.054 | 4230 | | | | |
| 10000 | | 18x40 | 0.018 | 0.047 | 4290 | | | | |

※13mm may be replaced by 12.5mm upon customer's request.

ATD Series

Standard Ratings

D×L (mm); R.C.(mA rms) at 105°C 100KHz ; IMP (Ω max) at 20°C,-10°C 100KHz

| Cap (μF) | V | 35 | | | | 50 | | | | |
|----------|-------|--------|-------|-------|-------|--------|-------|-------|-------|------|
| | | Item | D x L | IMP | | R.C. | D x L | IMP | | R.C. |
| | | | | 20°C | -10°C | | | 20°C | -10°C | |
| 22 | | | | | | 5x11 | 1.540 | 6.160 | 180 | |
| 33 | | 5x11 | 0.690 | 2.780 | 220 | | | | | |
| 47 | | 6.3x11 | 0.430 | 1.700 | 280 | 6.3x11 | 0.780 | 3.300 | 220 | |
| 56 | | 6.3x11 | 0.400 | 1.580 | 340 | 6.3x11 | 0.660 | 2.640 | 300 | |
| 100 | | 8x12 | 0.320 | 1.180 | 510 | 8x12 | 0.360 | 1.470 | 560 | |
| 120 | | | | | | 8x16 | 0.270 | 1.060 | 740 | |
| 150 | | 8x12 | 0.160 | 0.630 | 650 | 10x13 | 0.270 | 1.060 | 770 | |
| 180 | | | | | | 8x20 | 0.200 | 0.800 | 920 | |
| 220 | | 8x16 | 0.110 | 0.430 | 850 | 10x16 | 0.190 | 0.750 | 1050 | |
| | | 10x13 | 0.100 | 0.390 | 865 | | | | | |
| 270 | | 8x20 | 0.088 | 0.320 | 1060 | 10x20 | 0.140 | 0.530 | 1230 | |
| 330 | | 10x16 | 0.076 | 0.290 | 1210 | 10x25 | 0.120 | 0.490 | 1450 | |
| 470 | | 10x20 | 0.058 | 0.220 | 1410 | 10x30 | 0.100 | 0.380 | 1695 | |
| | 13x21 | | | | | 0.100 | 0.340 | 1670 | | |
| 560 | | 10x25 | 0.053 | 0.200 | 1650 | 13x25 | 0.080 | 0.250 | 1950 | |
| 680 | | 10x30 | 0.040 | 0.150 | 1920 | 13x30 | 0.072 | 0.230 | 2320 | |
| | | 13x21 | 0.044 | 0.160 | 1910 | | | | | |
| 820 | | | | | | 13x35 | 0.058 | 0.180 | 2520 | |
| 1000 | | 13x25 | 0.037 | 0.110 | 2230 | 13x40 | 0.050 | 0.160 | 2930 | |
| | 16x26 | | | | | 0.062 | 0.170 | 2555 | | |
| | 16x32 | | | | | 0.052 | 0.150 | 3020 | | |
| 1200 | | 13x30 | 0.032 | 0.098 | 2660 | 18x25 | 0.062 | 0.160 | 2750 | |
| | | | | | | 16x36 | 0.046 | 0.130 | 3150 | |
| 1500 | | 13x35 | 0.028 | 0.083 | 2880 | 16x40 | 0.042 | 0.110 | 3720 | |
| | | 16x26 | 0.028 | 0.076 | 2940 | 18x32 | 0.052 | 0.130 | 3640 | |
| 1800 | | 16x32 | 0.023 | 0.064 | 3500 | 18x35 | 0.044 | 0.100 | 3690 | |
| | | 18x25 | 0.026 | 0.063 | 3140 | | | | | |
| 2700 | | 16x36 | 0.022 | 0.057 | 3620 | 18x40 | 0.038 | 0.090 | 3810 | |
| | | 18x32 | 0.021 | 0.052 | 4180 | | | | | |
| 3300 | | 16x40 | 0.020 | 0.050 | 4090 | | | | | |
| | | 18x35 | 0.021 | 0.050 | 4230 | | | | | |
| 3900 | | 18x40 | 0.019 | 0.044 | 4290 | | | | | |

※13mm may be replaced by 12.5mm upon customer's request.

ATD Series

Standard Ratings

D×L (mm); R.C.(mA rms) at 105°C 100KHz ; IMP (Ω max) at 20°C,-10°C 100KHz

| Cap (μF) | V | 63 | | | 100 | | | | |
|----------|-------|--------|-------|-------|-------|--------|--------|-------|------|
| | | D x L | IMP | | R.C. | D x L | IMP | | R.C. |
| | | | 20°C | -10°C | | | 20°C | -10°C | |
| 6.8 | | | | | 5x11 | 2.780 | 11.640 | 56 | |
| 15 | | 5x11 | 2.20 | 9.20 | 56 | 6.3x11 | 1.520 | 6.330 | 120 |
| 27 | | | | | 8x12 | 0.980 | 4.390 | 235 | |
| 33 | | 6.3x11 | 1.20 | 5.00 | 120 | | | | |
| 39 | | | | | 8x16 | 0.570 | 2.660 | 280 | |
| 47 | | 8x12 | 0.68 | 3.10 | 190 | 10x13 | 0.550 | 2.280 | 290 |
| 56 | | 8x12 | 0.62 | 2.80 | 235 | 8x20 | 0.410 | 2.020 | 330 |
| 68 | | | | | 10x16 | 0.380 | 1.900 | 358 | |
| 82 | | 8x16 | 0.45 | 2.10 | 310 | 10x20 | 0.270 | 1.190 | 470 |
| | | 10x13 | 0.43 | 1.80 | 300 | | | | |
| 100 | | 10x16 | 0.35 | 1.80 | 320 | 10x25 | 0.260 | 1.070 | 536 |
| 120 | | 8x20 | 0.33 | 1.60 | 362 | 10x30 | 0.190 | 0.900 | 666 |
| | | 10x16 | 0.30 | 1.50 | 357 | 13x21 | 0.210 | 0.810 | 690 |
| 180 | | 10x20 | 0.20 | 0.94 | 470 | 13x25 | 0.160 | 0.570 | 790 |
| 220 | | 10x25 | 0.20 | 0.84 | 531 | 13x30 | 0.130 | 0.530 | 905 |
| | 16x22 | | | | | 0.120 | 0.470 | 1050 | |
| 270 | | 10x30 | 0.15 | 0.70 | 663 | 13x35 | 0.110 | 0.450 | 1060 |
| | | 13x21 | 0.13 | 0.65 | 690 | 16x26 | 0.095 | 0.340 | 1250 |
| 330 | | 13x25 | 0.12 | 0.45 | 790 | 13x40 | 0.092 | 0.380 | 1190 |
| 390 | | | | | | 16x32 | 0.071 | 0.260 | 1570 |
| | | | | | | 18x25 | 0.075 | 0.270 | 1490 |
| 470 | | 13x30 | 0.100 | 0.420 | 910 | 16x36 | 0.061 | 0.220 | 1790 |
| | 18x32 | | | | | 0.063 | 0.220 | 1640 | |
| 560 | | 13x35 | 0.082 | 0.350 | 1050 | 16x40 | 0.054 | 0.190 | 2030 |
| | | 16x26 | 0.073 | 0.270 | 1250 | | | | |
| 680 | | 13x40 | 0.070 | 0.300 | 1190 | 18x35 | 0.054 | 0.190 | 1790 |
| 820 | | 16x32 | 0.053 | 0.200 | 1580 | 18x40 | 0.049 | 0.170 | 2340 |
| | | 18x25 | 0.057 | 0.210 | 1490 | | | | |
| 1000 | | 16x36 | 0.045 | 0.170 | 1790 | | | | |
| | | 18x32 | 0.047 | 0.170 | 1640 | | | | |
| 1200 | | 16x40 | 0.039 | 0.150 | 2020 | | | | |
| | | 18x35 | 0.040 | 0.150 | 1790 | | | | |
| 1500 | | 18x40 | 0.035 | 0.130 | 2340 | | | | |

※13mm may be replaced by 12.5mm upon customer's request.

ATE Series

- Anhydrous product.
- 105°C high-temperature, high reliability and long life.
- Suitable for office communicative and industrial equipments.
- RoHS Compliant & Halogen Free.

Specifications

| Items | Characteristics | | | | | |
|---|---|---|------|------|------|---------|
| Capacitance Tolerance | ± 20% (120Hz, 20°C) | | | | | |
| Operating Temperature Range | -40 ~ +105°C | | | | | |
| Rated Voltage Range | 160 ~ 450V | | | | | |
| Leakage Current | $I \leq 0.03CV + 20 (\mu A)$ (After 3 minutes application of DC rated voltage, at 20°C) | | | | | |
| Dissipation Factor | Measurement Frequency: 120Hz. Temperature: 20°C | | | | | |
| | Rated Voltage (V) | 160 | 200 | 250 | 350 | 400~450 |
| | tan δ (Max) | 0.20 | 0.20 | 0.20 | 0.25 | 0.25 |
| When nominal capacitance over 1000 μ F, tan δ shall be added 0.02 to the listed value with increase of every 1000 μ F. | | | | | | |
| Low Temperature Stability Impedance Ratio (Max) | Measurement Frequency: 120Hz. | | | | | |
| | Rated Voltage(V) | 160 | 200 | 250 | 350 | 400 |
| | Z(-25°C)/Z(20°C) | 3 | 3 | 3 | 6 | 15 |
| Load Life | 5,000 hours, with application of rated voltage at 105°C ($\phi D \leq 8$: 3000 hours; $\phi D = 10$: 4000 hours) | | | | | |
| | Capacitance Change | Within ± 25% of Initial Value | | | | |
| | tan δ | 200% or less of Initial Specified Value | | | | |
| | Leakage Current | Initial Specified Value or less | | | | |
| Shelf Life | The following specifications shall be satisfied when the capacitors are restored to 20°C after exposing them for 1,000 hours 105°C without voltage applied. Before the measurement, the capacitor shall be preconditioned by applying voltage according to them 4.1 of JIS C5101-4. | | | | | |
| | Capacitance Change | Within ± 20% of Initial Value | | | | |
| | tan δ | 200% or less of Initial Specified Value | | | | |
| | Leakage Current | Initial Specified Value or less | | | | |
| Standards | JIS C-5101-4(IEC 60384) | | | | | |

Frequency Coefficient for Ripple Current

| Rated Voltage (V) | Capacitance (μ F) | Frequency (Hz) | | | |
|-------------------|------------------------|----------------|------|------|------------|
| | | 50 | 120 | 1K | $\geq 10K$ |
| ≥ 160 | 2.2 ~ 220 | 0.80 | 1.00 | 1.30 | 1.40 |

The endurance of capacitors is reduced with internal heating produced by ripple current at the rate of halving the lifetime with every 5°C rise.
When long life performance is required in actual use, the RMS ripple current has to be reduced.

ATE Series

Dimensions (mm)

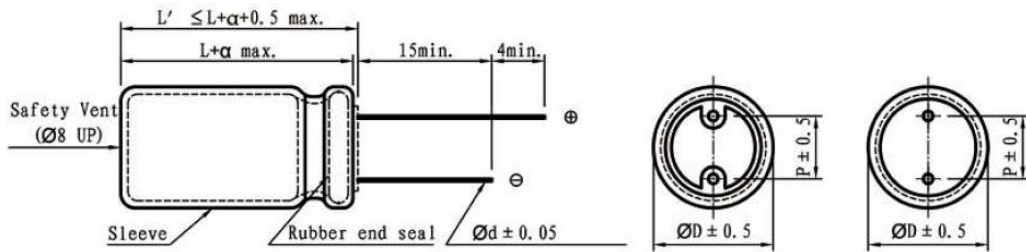

| | | | | | | |
|-----|-----|-----|-----|-----|-----|-----|
| Ø D | 6.3 | 8 | 10 | 13 | 16 | 18 |
| P | 2.5 | 3.5 | 5.0 | 5.0 | 7.5 | 7.5 |
| Ø d | 0.5 | 0.5 | 0.6 | 0.6 | 0.8 | 0.8 |

| | |
|---|--------------|
| α | (L < 16) 1.0 |
| | (L ≥ 16) 2.0 |

Standard Ratings

DxL (mm); R.C. (mA rms) at 105°C 120Hz

| Cap (µF) | V | 160 | | 200 | | 250 | | 400 | | 450 | | |
|----------|---|------|--------|------|--------|------|-------|------|-------|------|-------|------|
| | | Item | D x L | R.C. | D x L | R.C. | D x L | R.C. | D x L | R.C. | D x L | R.C. |
| 2.2 | | | 6.3x11 | 29 | 6.3x11 | 29 | 8x12 | 36 | 8x12 | 36 | 8x12 | 36 |
| 3.3 | | | 8x12 | 35 | 8x12 | 36 | 8x12 | 52 | 8x12 | 45 | 8x12 | 52 |
| 4.7 | | | 8x12 | 44 | 8x12 | 52 | 8x12 | 57 | 10x13 | 57 | 10x13 | 62 |
| 10 | | | 10x13 | 78 | 10x16 | 83 | 10x16 | 104 | 10x20 | 95 | 10x20 | 104 |
| 22 | | | 10x16 | 135 | 10x20 | 145 | 13x21 | 176 | 13x21 | 168 | 13x25 | 197 |
| 33 | | | 10x20 | 176 | 13x21 | 208 | 13x21 | 234 | 13x25 | 213 | 16x22 | 249 |
| 39 | | | 10x20 | 197 | 13x21 | 228 | 13x25 | 260 | 16x22 | 213 | 16x26 | 312 |
| 47 | | | 13x21 | 239 | 13x21 | 260 | 13x25 | 291 | 16x26 | 332 | 16x32 | 343 |
| 68 | | | 13x25 | 270 | 13x25 | 291 | 16x22 | 322 | 16x26 | 364 | 18x25 | 364 |
| 82 | | | 16x22 | 332 | 16x26 | 364 | 16x32 | 405 | 18x25 | 436 | 18x32 | 603 |
| 100 | | | 16x26 | 364 | 16x32 | 499 | 16x36 | 520 | 18x32 | 572 | 18x35 | 686 |
| 120 | | | | | | | | | 18x40 | 676 | 18x40 | 800 |

※13mm may be replaced by 12.5mm upon customer's request.

SIA Series

- Snap-in type, 85°C 2000 hours standard product.
- Suitable for filter circuit of home appliance, e.g. TV set, audio, etc.
- RoHS Compliant.

Specifications

| Items | Characteristics | | | | | | | | |
|-----------------------------|---|---|------|---------|--------------|---------|---------|------|---------|
| Capacitance Tolerance | ± 20% (120Hz, 20°C) | | | | | | | | |
| Operating Temperature Range | -40 ~ +85°C | | | | -25 ~ +85°C | | | | |
| Rated Voltage Range | 10 ~ 100VDC | | | | 160 ~ 500VDC | | | | |
| Leakage Current | I ≤ 3V _{CV} (μA) (After 5 minutes application of DC rated voltage, at 20 °C) | | | | | | | | |
| Dissipation Factor | Measurement Frequency: 120Hz. Temperature: 20°C | | | | | | | | |
| | Rated Voltage (V) | 10 | 16 | 25 | 35 | 50-80 | 100-250 | 300 | 350-500 |
| | tan δ(Max) | 0.50 | 0.40 | 0.35 | 0.30 | 0.25 | 0.20 | 0.25 | 0.25 |
| | When nominal capacitance over 1000μF, tan δ shall be added 0.01 to the listed value with increase of every 1000μF. | | | | | | | | |
| Low Temperature Stability | Measurement Frequency: 120Hz. | | | | | | | | |
| | Rated Voltage(V) | 10-100 | | 160-250 | | 350-500 | | | |
| Impedance Ratio (Max) | Z(-25°C) / Z(20°C) | 4 | | 4 | | 8 | | | |
| | Z(-40°C) / Z(20°C) | 12 | | 15 | | - | | | |
| Load Life | 2,000 hours, with application of rated voltage at 85°C | | | | | | | | |
| | Capacitance Change | Within ± 20% of Initial Value | | | | | | | |
| | tan δ | 200% or less of Initial Specified Value | | | | | | | |
| | Leakage Current | Initial Specified Value or less | | | | | | | |
| Shelf Life | The following specifications shall be satisfied when the capacitors are restored to 25°C after exposing them for 1,000 hours 85°C without voltage applied. Before the measurement the capacitor shall be preconditioned by applying voltage according to them 4.1 of JIS C5101-4. | | | | | | | | |
| | Capacitance Change | Within ± 20% of Initial Value | | | | | | | |
| | tan δ | 150% or less of Initial Specified Value | | | | | | | |
| | Leakage Current | Initial Specified Value or less | | | | | | | |
| Standards | JIS C-5101-4(IEC 60384) | | | | | | | | |

Frequency Coefficient for Ripple Current

| Rated Voltage (V) | Frequency (Hz) | | | |
|-------------------|----------------|------|------|-------|
| | 50 | 120 | 1K | ≥ 10K |
| 10-100 | 0.88 | 1.00 | 1.15 | 1.15 |
| 160-250 | 0.85 | 1.00 | 1.15 | 1.20 |
| 350-500 | 0.88 | 1.00 | 1.10 | 1.15 |

The endurance of capacitors is reduced with internal heating produced by ripple current at the rate of halving the lifetime with every 10°C rise. When long life performance is required in actual use, the rms ripple current has to be reduced.

SIA Series

Dimensions (mm)

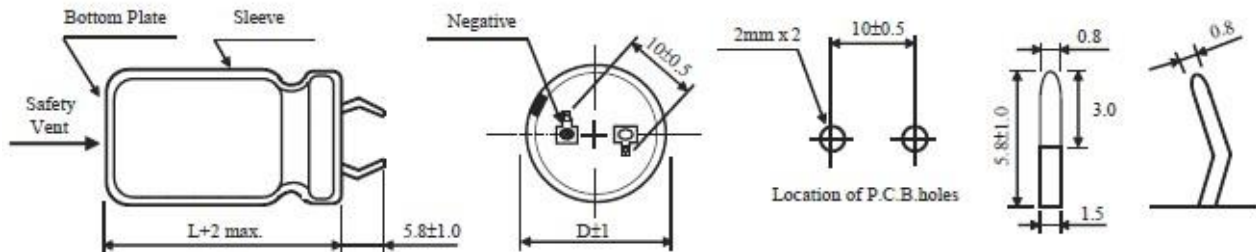

Standard Ratings

DxL(mm) ; R.C.(mA RMS) at 85°C 120Hz.

| Cap (µF) | V | 10 | | 16 | | 25 | | 35 | | 50 | | 63 | | 80 | |
|-------------|------|----------------|------|----------------|-------|----------------|------|----------------|------|----------------|------|----------------|------|----------------|------|
| | Item | D x L | R.C. | D x L | R.C. | D x L | R.C. | D x L | R.C. | D x L | R.C. | D x L | R.C. | D x L | R.C. |
| 820 | | | | | | | | | | | | | | 22x25 | 1.34 |
| 1000 | | | | | | | | | | | | 22x25 | 1.52 | 22x25 | 1.64 |
| 1500 | | | | | | | | | | | | 22x25 | 1.68 | 22x30 25x25 | 1.80 |
| 2200 | | | | | | | | | | 22x25 | 2.08 | 22x30 25x25 | 2.58 | 22x35 25x30 | 2.65 |
| 2700 | | | | | | | | | | 22x30 | 2.32 | 22x35 25x30 | 2.80 | 22x40 25x30 | 2.82 |
| 3300 | | | | | | | | | | 22x30 25x25 | 2.65 | 22x40 25x30 | 2.88 | 22x45 25x40 | 3.30 |
| 3900 | | | | | | | | 22x25 | 2.44 | 22x35 25x30 | 2.72 | 22x45 25x35 | 3.15 | 25x45 30x35 | 3.40 |
| 4700 | | | | | | 22x25 | 2.49 | 22x30 25x25 | 2.64 | 22x40 25x35 | 3.09 | 22x50 25x40 | 3.39 | 25x50 30x40 | 3.62 |
| 6800 | | | | 22x25 | 2.40 | 22x30 25x25 | 2.57 | 22x40 25x30 | 2.81 | 22x50 25x40 | 3.86 | 25x50 30x40 | 4.34 | 30x50 35x40 | 4.68 |
| 8200 | | | | 22x25 | 2.90 | 22x35 25x25 | 2.96 | 22x45 25x35 | 3.12 | 25x50 30x40 | 4.42 | 30x45 35x35 | 4.84 | 35x45 | 4.96 |
| 10000 | | 22x25 | 2.08 | 22x30 | 3.08 | 22x40 25x30 | 3.40 | 22x50 25x40 | 3.55 | 25x50 30x40 | 4.98 | 35x40 | 5.51 | 35x50 | 6.08 |
| 12000 | | 22x25 | 2.40 | 22x30 25x25 | 3.50 | 22x45 25x35 | 3.61 | 25x45 30x35 | 4.02 | 30x50 35x35 | 5.16 | 35x50 | 6.22 | | |
| 15000 | | 22x30 | 2.76 | 22x35 25x30 | 3.95 | 25x45 30x35 | 4.10 | 30x40 35x35 | 5.01 | 35x45 | 6.45 | | | | |
| 18000 | | 22x35 25x25 | 3.14 | 22x40 25x35 | 4.40 | 25x45 30x35 | 4.47 | 30x45 35x40 | 5.55 | 35x50 | 6.72 | | | | |
| 22000 | | 22x40 25x30 | 3.53 | 22x50 25x40 | 4.71 | 25x50 30x45 | 5.22 | 35x45 | 6.02 | | | | | | |
| 27000 | | 22x45 25x35 | 4.18 | 25x45 30x35 | 5.51 | 30x50 35x40 | 6.02 | 35x50 | 6.85 | | | | | | |
| 33000 | | 22x50 25x40 | 5.21 | 25x50 30x40 | 5.82 | 35x45 | 6.78 | 35x45 | 6.95 | | | | | | |
| 39000 | | 25x45 30x35 | 5.30 | 30x45 35x35 | 6.36 | 35x45 | 7.60 | 35x50 | 7.16 | | | | | | |
| 47000 | | 30x40 | 5.98 | 30x50 35x40 | 6.99 | 35x50 | 7.88 | | | | | | | | |
| 56000 | | 30x45 | 6.60 | 35x45 | 7.17 | | | | | | | | | | |
| 68000 | | 35x40 | 7.28 | 35x50 | 10.10 | | | | | | | | | | |

SIA Series

Standard Ratings

DxL(mm) ; R.C.(mA rms) at 85°C 120Hz.

| Cap (µF) | V | 100 | | 160 | | 200 | | 250 | | 350 | | 400 | | 450 | | 500 | |
|----------|------|----------------|------|----------------|------|----------------|------|----------------|------|----------------|------|----------------|------|----------------|------|----------------|--------------|
| | Item | D x L | R.C. | D x L | R.C. | D x L | R.C. | D x L | R.C. | D x L | R.C. | D x L | R.C. | D x L | R.C. | D x L | R.C. |
| 47 | | | | | | | | | | | | 22x25 | 0.42 | 22x25 | 0.46 | 22x35 | 0.47 |
| 100 | | | | | | | | | | 22x25 | 0.77 | 22x30 25x25 | 1.05 | 22x35 25x25 | 1.10 | 25x40 | 1.13 |
| 120 | | | | | | | | | | 22x30 25x25 | 0.93 | 22x35 25x25 | 1.15 | 22x40 25x30 | 1.21 | 25x45 | 1.25 |
| 150 | | | | | | | | 22x25 | 1.1 | 22x35 25x30 | 1.16 | 22x40 25x30 | 1.25 | 22x45 25x35 | 1.44 | 25x50 30x35 | 1.50 1.48 |
| 220 | | | | 22x20 | 1.12 | 22x25 25x20 | 1.37 | 22x30 25x25 | 1.44 | 22x45 25x35 | 1.47 | 22x50 25x40 | 1.76 | 25x45 30x40 | 1.77 | 30x45 | 1.78 |
| 330 | | | | 22x25 25x20 | 1.45 | 22x30 25x25 | 1.88 | 22x35 25x30 | 1.93 | 25x50 30x40 | 1.99 | 30x40 35x30 | 2.30 | 30x45 35x40 | 2.79 | 35x45 | 2.81 |
| 470 | | | | 22x30 25x25 | 1.83 | 22x40 25x30 | 2.25 | 22x45 25x35 | 2.39 | 30x50 35x40 | 2.44 | 35x45 | 2.82 | 35x50 | 2.92 | 35x60 | 3.00 |
| 560 | | | | 22x35 25x30 | 2.03 | 22x40 25x30 | 2.57 | 25x40 30x35 | 2.81 | 35x45 | 3.29 | 35x50 | 3.36 | 35x55 | 3.15 | 35x60 | 3.03 |
| 680 | | 22x25 | 1.54 | 22x35 25x30 | 2.37 | 22x50 25x40 | 2.84 | 25x50 30x40 | 3.22 | 35x50 | 3.44 | 35x50 | 3.50 | 35x60 | 3.36 | 35x70 | 3.27 |
| 820 | | 22x25 25x20 | 1.88 | 22x40 25x35 | 2.75 | 25x45 30x35 | 3.35 | 30x45 35x40 | 3.51 | 35x50 | 3.58 | 35x60 | 3.83 | 35x65 | 3.59 | 40x70 | 3.76 |
| 1000 | | 22x30 25x25 | 1.94 | 25x40 30x35 | 3.22 | 25x50 30x40 | 3.79 | 30x50 35x45 | 3.94 | 35x55 | 3.89 | 35x65 | 4.20 | 35x70 | 3.81 | 45x80 | 4.21 |
| 1200 | | 22x30 25x25 | 2.11 | 25x40 30x35 | 3.41 | 25x50 30x40 | 4.08 | 30x50 35x45 | 4.45 | 35x60 | 4.17 | 35x70 | 4.41 | 40x70 | 4.01 | 45x90 | 4.50 |
| 1500 | | 22x35 25x30 | 2.47 | 30x45 35x35 | 3.96 | 30x50 35x40 | 5.02 | 35x50 | 5.36 | 35x65 | 4.56 | 40x70 | 4.52 | 45x70 | 4.13 | 45x100 | 4.80 |
| 2200 | | 22x45 25x40 | 3.15 | 35x45 | 4.68 | 35x50 | 6.09 | 40x60 | 6.13 | 47x75 | 5.75 | 45x85 | 5.64 | 45x100 | 5.22 | | |
| 2700 | | 25x45 30x35 | 3.72 | 35x50 | 5.35 | | | | | | | | | | | | |
| 3300 | | 25x50 30x40 | 4.06 | | | | | | | | | | | | | | |
| 3900 | | 30x45 35x35 | 4.55 | | | | | | | | | | | | | | |
| 4700 | | 30x50 35x40 | 5.12 | | | | | | | | | | | | | | |
| 6800 | | 35x50 | 5.85 | | | | | | | | | | | | | | |

SIC Series

- Snap-in type, 105°C 2000 hours standard product.
- High temperature and high ripple current resistance.
- Suitable for computer equipment, inverter air conditioner etc.
- RoHS Compliant.

Specifications

| Items | Characteristics | | | | | | | | | | | | | |
|---|---|---|------|------|------|------|----------|---------------|-----------|------|-----------|------|-----------|-----------|
| Capacitance Tolerance | ± 20% (120Hz, 20°C) | | | | | | | | | | | | | |
| Operating Temperature Range | -40 ~ +105°C | | | | | | | -25 ~ +105°C | | | | | | |
| Rated Voltage Range | 10 ~ 250 VDC | | | | | | | 350 ~ 500 VDC | | | | | | |
| Leakage Current | I ≤ 3v(CV) (μA) (After 5 minutes, application of DC rated voltage, at 20°C) | | | | | | | | | | | | | |
| Dissipation Factor | Measurement Frequency: 120Hz. Temperature: 20°C | | | | | | | | | | | | | |
| | Rated Voltage(V) | 6.3 | 10 | 16 | 25 | 35 | 50 | 63 | 80 | 100 | 160 ~ 250 | 315 | 350 ~ 500 | 550 ~ 600 |
| | tan δ(Max) | 0.50 | 0.45 | 0.40 | 0.35 | 0.30 | 0.25 | 0.25 | 0.20 | 0.20 | 0.15 | 0.20 | 0.20 | 0.20 |
| When nominal capacitance over 1000μF, tanδ shall be added 0.01 to the listed value with increase of every 1000μF. | | | | | | | | | | | | | | |
| Low Temperature Stability | Measurement Frequency: 120Hz. | | | | | | | | | | | | | |
| | Rated Voltage(V) | 10 | 16 | 25 | 35 | 50 | 63 ~ 100 | 160 ~ 250 | 350 ~ 500 | | | | | |
| Impedance Ratio (Max) | Z(-25°C)/Z(20°C) | 6 | 6 | 4 | 4 | 4 | 4 | 4 | 4 | 8 | | | | |
| | Z(-40°C)/Z(20°C) | 16 | 15 | 10 | 10 | 8 | 6 | 15 | - | | | | | |
| Load Life | 2,000 hours, with application of rated voltage at 105°C | | | | | | | | | | | | | |
| | Capacitance Change | Within ± 20% of Initial Value | | | | | | | | | | | | |
| | tan δ | 200% or less of Initial Specified Value | | | | | | | | | | | | |
| | Leakage Current | Initial Specified Value or less | | | | | | | | | | | | |
| Shelf Life | The following specifications shall be satisfied when the capacitors are restored to 20°C after exposing them for 1,000 hours 105°C without voltage applied. Before the measurement, the capacitor shall be preconditioned by applying voltage according to them 4.1 of JIS C5101-4. | | | | | | | | | | | | | |
| | Capacitance Change | Within ± 15% of Initial Value | | | | | | | | | | | | |
| | tan δ | 200% or less of Initial Specified Value | | | | | | | | | | | | |
| | Leakage Current | Initial Specified Value or less | | | | | | | | | | | | |
| Standards | JIS C-5101-4 (IEC 60384) | | | | | | | | | | | | | |

Frequency Coefficient for Ripple Current

| Rated Voltage (V) | Frequency (Hz) | | | | |
|-------------------|----------------|------|------|------|------|
| | 50 | 120 | 1K | 10K | 100K |
| 10 ~ 100 | 0.88 | 1.00 | 1.15 | 1.15 | 1.20 |
| 160 ~ 250 | 0.85 | 1.00 | 1.15 | 1.20 | 1.20 |
| 350 ~ 500 | 0.88 | 1.00 | 1.10 | 1.15 | 1.20 |

The endurance of capacitors is reduced with internal heating produced by ripple current at the rate of having the lifetime with every 5°C rise.

When long life performance is required in actual use, the rms ripple current has to be reduced.

SIC Series

Dimensions (mm)

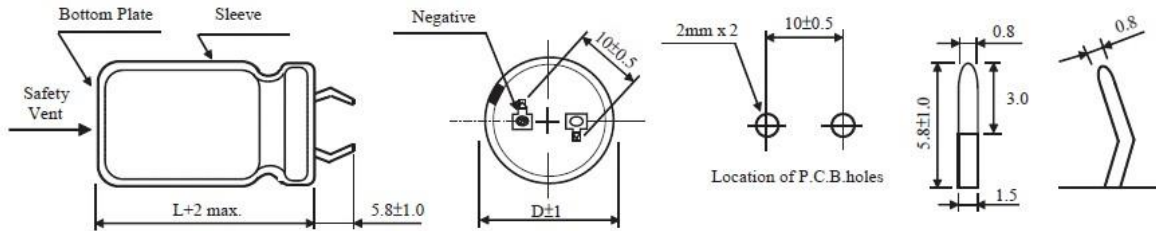

Standard Ratings

DxL(mm); R.C. (mA rms) at 105°C 120Hz.

| Cap (µF) | V | 10 | | 16 | | 25 | | 35 | | 50 | |
|----------|------|-------|------|-------|------|-------|------|-------|------|-------|------|
| | Item | D x L | R.C. | D x L | R.C. | D x L | R.C. | D x L | R.C. | D x L | R.C. |
| 1500 | | | | | | | | | | 22x25 | 1.20 |
| 1800 | | | | | | | | | | 22x30 | 1.40 |
| 2200 | | | | | | | | | | 22x30 | 1.60 |
| | | | | | | | | | | 25x25 | |
| 2700 | | | | | | | | 22x25 | 1.21 | 22x35 | 1.73 |
| | | | | | | | | | | 25x30 | 1.97 |
| 3300 | | | | | | | | 22x30 | 1.36 | 22x40 | |
| | | | | | | | | | | 25x30 | 2.23 |
| 3900 | | | | | | 22x25 | 1.35 | 22x30 | 1.57 | 22x45 | |
| | | | | | | | | | | 25x35 | 2.45 |
| 4700 | | | | | | 22x30 | 1.58 | 22x35 | 1.77 | 22x50 | |
| | | | | | | | | 25x25 | | 25x40 | 2.74 |
| 5600 | | | | | | 22x30 | 1.75 | 22x40 | 1.99 | 25x45 | |
| | | | | | | 25x25 | | 25x30 | | 30x35 | 3.31 |
| 6800 | | | | 22x25 | 1.80 | 22x35 | 2.02 | 22x45 | 2.29 | 30x40 | |
| | | | | | | 25x30 | | 25x35 | | 35x30 | 3.60 |
| 8200 | | | | 22x30 | 2.08 | 22x40 | 2.18 | 22x50 | 2.58 | 30x45 | |
| | | | | 25x25 | | 25x35 | | 25x40 | | 35x35 | 4.02 |
| 10000 | | 22x25 | 1.88 | 22x35 | 2.15 | 22x45 | 2.48 | 25x45 | 2.90 | 35x40 | |
| | | | | 25x30 | | 25x40 | | 30x35 | | | 4.52 |
| 12000 | | 22x30 | 2.18 | 22x40 | 2.31 | 22x50 | 2.86 | 25x50 | 3.24 | 35x50 | |
| | | 25x25 | | 25x30 | | 25x45 | | 30x40 | | | |
| 15000 | | 22x35 | 2.27 | 22x45 | 2.69 | 25x50 | 3.15 | 30x45 | 3.65 | | |
| | | 25x30 | | 25x35 | | 30x40 | | 35x35 | | | |
| 18000 | | 22x40 | 2.41 | 22x50 | 3.20 | 30x45 | 3.55 | 35x40 | 4.13 | | |
| | | 25x30 | | 25x40 | | 35x35 | | | | | |
| 22000 | | 22x45 | 2.68 | 25x45 | 3.40 | 30x50 | 4.00 | 35x50 | 4.78 | | |
| | | 25x35 | | 30x35 | | 35x40 | | | | | |
| 27000 | | 25x40 | 3.17 | 30x40 | 3.85 | 35x45 | 4.55 | | | | |
| | | 30x35 | | 35x35 | | | | | | | |
| 33000 | | 25x45 | 3.39 | 30x50 | 4.32 | 35x50 | 5.56 | | | | |
| | | 30x35 | | 35x40 | | | | | | | |
| 39000 | | 25x50 | 3.72 | 35x40 | 4.85 | | | | | | |
| | | 30x40 | | | | | | | | | |
| 47000 | | 30x45 | 4.22 | 35x50 | 5.56 | | | | | | |
| | | 35x35 | | | | | | | | | |
| 56000 | | 35x40 | 5.00 | | | | | | | | |
| 68000 | | 35x50 | 5.21 | | | | | | | | |

SIC Series

Standard Ratings

DxL(mm) ; R.C.(A rms) at 105°C 120Hz.

| Cap (µF) | V Item | 63 | | 80 | | 100 | | 160 | | 200 | |
|-------------|-----------|-------|-------|-------|-------|-------|-------|-------|-------|-------|------|
| | | D x L | R.C. | D x L | R.C. | D x L | R.C. | D x L | R.C. | D x L | R.C. |
| 220 | | | | | | | | | | 22x25 | 0.82 |
| 270 | | | | | | | | 22x25 | 1.04 | 22x30 | 1.07 |
| 330 | | | | | | | | 22x30 | 1.26 | 22x30 | 1.28 |
| 390 | | | | | | | | 22x30 | 1.29 | 22x35 | 1.31 |
| | | | | | | | | 25x25 | | 25x30 | |
| 470 | | | | | | | | 22x35 | 1.56 | 22x40 | 1.58 |
| | | | | | | | | 25x30 | | 25x30 | |
| 560 | | | | | | 22x25 | 1.02 | 22x40 | 1.69 | 22x45 | 1.72 |
| | | | | | | | | 25x30 | | 25x35 | |
| 680 | | | | | | 22x30 | 1.12 | 22x45 | 1.72 | 25x40 | 1.75 |
| | | | | | | | | 25x35 | | 30x30 | |
| 820 | | | | 22x25 | 1.04 | 22x30 | 1.32 | 22x50 | 1.99 | 25x50 | 2.04 |
| | | | | | | 25x25 | | 25x40 | | 30x35 | |
| 1000 | | | | 22x30 | 1.21 | 22x35 | 1.45 | 25x45 | 2.20 | 30x45 | 2.30 |
| | | | | | | 25x30 | | 30x35 | | 35x35 | |
| 1200 | 25x25 | 1.21 | 22x35 | 1.29 | 22x40 | 1.68 | 30x40 | 2.45 | 30x50 | 2.65 | |
| | | | 25x25 | | 25x35 | | 35x35 | | 35x40 | | |
| 1500 | 22x30 | 1.45 | 22x40 | 1.57 | 22x45 | 1.98 | 30x50 | 3.06 | 35x45 | 3.07 | |
| | 25x25 | | 25x30 | | 25x40 | | 35x40 | | | | |
| 1800 | 22x35 | 1.59 | 22x45 | 1.72 | 25x45 | 2.23 | 35x45 | 3.14 | | | |
| | 25x30 | | 25x35 | | 30x35 | | | | | | |
| 2200 | 22x40 | 1.84 | 25x40 | 2.01 | 25x50 | 2.53 | 35x50 | 3.50 | | | |
| | 25x30 | | 30x30 | | 30x40 | | | | | | |
| 2700 | 22x45 | 2.12 | 25x45 | 2.32 | 30x45 | 2.82 | | | | | |
| | 25x35 | | 30x35 | | 35x35 | | | | | | |
| 3300 | 25x40 | 2.30 | 30x40 | 2.62 | 30x50 | 3.32 | | | | | |
| | 30x30 | | 35x30 | | 35x40 | | | | | | |
| 3900 | 25x45 | 2.42 | 30x45 | 2.84 | 35x45 | 3.62 | | | | | |
| | 30x35 | | 35x35 | | | | | | | | |
| 4700 | 25x50 | 2.91 | 30x50 | 3.29 | 35x50 | 3.80 | | | | | |
| | 30x40 | | | | | | | | | | |
| 5600 | 30x45 | 3.18 | 35x45 | 3.82 | | | | | | | |
| | 35x35 | | | | | | | | | | |
| 6800 | 30x50 | 3.54 | 35x50 | 3.92 | | | | | | | |
| | 35x40 | | | | | | | | | | |
| 8200 | 35x45 | 3.82 | 35x50 | 4.05 | | | | | | | |
| 10000 | 35x50 | 4.50 | 35x55 | 4.85 | | | | | | | |

SIC Series

Standard Ratings

DxL(mm) ; R.C.(A rms) at 105°C 120Hz.

| Cap (µF) | V (Code) Item | 250 | | 350 | | 400 | | 450 | | 500 | |
|-------------|---------------------|-------|------|-------|------|-------|------|-------|------|-------|------|
| | | D x L | R.C. | D x L | R.C. | D x L | R.C. | D x L | R.C. | D x L | R.C. |
| 68 | | | | | | 22x25 | 0.52 | 22x35 | 0.55 | 22x40 | 0.56 |
| | | | | | | | | 25x30 | | | |
| 82 | | | | 22x25 | 0.60 | 22x30 | 0.66 | 22x35 | 0.65 | 25x35 | 0.68 |
| | | | | | | | | 25x30 | | | |
| 100 | | | | 22x30 | 0.69 | 22x35 | 0.72 | 22x40 | 0.75 | 25x35 | 0.78 |
| | | | | | | 25x25 | | 25x30 | | | |
| 120 | 20x20 | 0.65 | | 22x35 | 0.76 | 22x40 | 0.75 | 22x45 | 0.83 | 25x45 | 0.85 |
| | | | | 25x30 | | 25x30 | | 25x40 | | | |
| 150 | 22x25 | 0.76 | | 22x40 | 0.79 | 22x45 | 0.89 | 22x50 | 0.95 | 25x50 | 1.01 |
| | | | | 25x30 | | 25x35 | | 25x40 | | 30x40 | |
| 180 | 22x30 | 0.98 | | 22x45 | 0.88 | 22x50 | 0.98 | 25x45 | 1.15 | 30x45 | 1.21 |
| | | | | 25x35 | | 25x40 | | 30x40 | | 35x35 | |
| 220 | 22x30 | 1.09 | | 22x50 | 0.98 | 25x45 | 1.12 | 30x45 | 1.24 | 30x45 | 1.35 |
| | 25x25 | | | 25x40 | | 30x35 | | 35x40 | | 35x40 | |
| 270 | 22x35 | 1.19 | | 25x45 | 1.10 | 25x50 | 1.29 | 30x50 | 1.46 | 35x45 | 1.53 |
| | 25x30 | | | 30x35 | | 30x40 | | 35x45 | | | |
| 330 | 22x40 | 1.35 | | 30x40 | 1.22 | 30x45 | 1.45 | 35x50 | 1.65 | 35x50 | 1.75 |
| | 25x35 | | | 35x35 | | 35x35 | | | | | |
| 390 | 22x45 | 1.52 | | 30x45 | 1.42 | 30x50 | 1.59 | 35x55 | 1.78 | | |
| | 25x35 | | | 35x40 | | 35x40 | | | | | |
| 470 | 22x50 | 1.63 | | 35x45 | 1.62 | 35x45 | 1.75 | | | | |
| | 25x40 | | | | | | | | | | |
| 560 | 25x45 | 1.84 | | 35x50 | 1.89 | 35x50 | 2.12 | | | | |
| | 30x35 | | | | | | | | | | |
| 680 | 25x50 | 2.05 | | 35x50 | 2.10 | 35x50 | 2.20 | | | | |
| | 30x40 | | | | | | | | | | |
| 820 | 30x45 | 2.29 | | 35x65 | 2.35 | 35x65 | 2.50 | | | | |
| | 35x35 | | | | | | | | | | |
| 1000 | 35x40 | 2.49 | | | | | | | | | |
| 1200 | 35x45 | 2.84 | | | | | | | | | |

SID Series

- Down size, load life extend to 3000 hours.
- 105°C, high temperature, high ripple current resistance and high reliability.
- RoHS Compliant.

Specifications

| Items | Characteristics | | | | | | | | | | | | |
|---|---|---|------|------|------|------|---------------|------|-----------|------|-----------|------|-----------|
| Capacitance Tolerance | ± 20% (120Hz, 20°C) | | | | | | | | | | | | |
| Operating Temperature Range | -40 ~ +55°C | | | | | | -25 ~ +105°C | | | | | | |
| Rated Voltage Range | 16 ~ 250 | | | | | | 350 ~ 450 VDC | | | | | | |
| Leakage Current | I ≤ 3VCV (μA) (After 5 minutes application of DC rated voltage, at 20°C) | | | | | | | | | | | | |
| Dissipation Factor | Measurement Frequency: 120Hz. Temperature: 20°C | | | | | | | | | | | | |
| | Rated Voltage (V) | 16 | 25 | 35 | 50 | 63 | 80 | 100 | 160 | 180 | 200 ~ 250 | 280 | 350 ~ 450 |
| | tan δ(Max) | 0.50 | 0.45 | 0.40 | 0.35 | 0.30 | 0.25 | 0.20 | 0.15 | 0.15 | 0.15 | 0.15 | 0.20 |
| | When nominal capacitance over 1000μF, tan δ shall be added 0.01 to the listed value with increase of every 1000μF. | | | | | | | | | | | | |
| Low Temperature Stability Impedance Ratio (Max) | Measurement Frequency: 120Hz. | | | | | | | | | | | | |
| | Rated Voltage(V) | 16 | 25 | 35 | 50 | 63 | 80 | 100 | 160 ~ 250 | 280 | 350 ~ 450 | | |
| | Z(-25°C)/Z(20°C) | 6 | 6 | 4 | 4 | 4 | 4 | 4 | 4 | 4 | 4 | 8 | |
| | Z(-40°C)/Z(20°C) | 16 | 15 | 10 | 10 | 8 | 6 | 6 | 6 | 15 | | | - |
| Load Life | 3,000 hours, with application of rated voltage at 105°C | | | | | | | | | | | | |
| | Capacitance Change | Within ± 20% of Initial Value | | | | | | | | | | | |
| | tan δ | 200% or less of Initial Specified Value | | | | | | | | | | | |
| | Leakage Current | Initial Specified Value or less | | | | | | | | | | | |
| Shelf Life | The following specifications shall be satisfied when the capacitors are restored to 20°C after exposing them for 1,000 hours 105°C without voltage applied. Before the measurement, the capacitor shall be preconditioned by applying voltage according to them 4.1 of JIS C5101-4. | | | | | | | | | | | | |
| | Capacitance Change | Within ± 15% of Initial Value | | | | | | | | | | | |
| | tan δ | 200% or less of Initial Specified Value | | | | | | | | | | | |
| | Leakage Current | Initial Specified Value or less | | | | | | | | | | | |
| Standards | JIS C-5101-4(IEC 60384) | | | | | | | | | | | | |

Frequency Coefficient for Ripple Current

| Rated Voltage (V) | Frequency (Hz) | | | | |
|-------------------|----------------|------|------|------|------|
| | 50 | 120 | 1K | 10K | 100K |
| 16 ~ 100 | 0.88 | 1.00 | 1.05 | 1.10 | 1.15 |
| 160 ~ 250 | 0.85 | 1.00 | 1.20 | 1.30 | 1.50 |
| 350 ~ 450 | 0.88 | 1.00 | 1.20 | 1.25 | 1.40 |

The endurance of capacitors is reduced with internal heating produced by ripple current at the rate of halving the lifetime with every 5°C rise. When long life performance is required in actual use, the RMS ripple current has to be reduced.

Dimensions (mm)

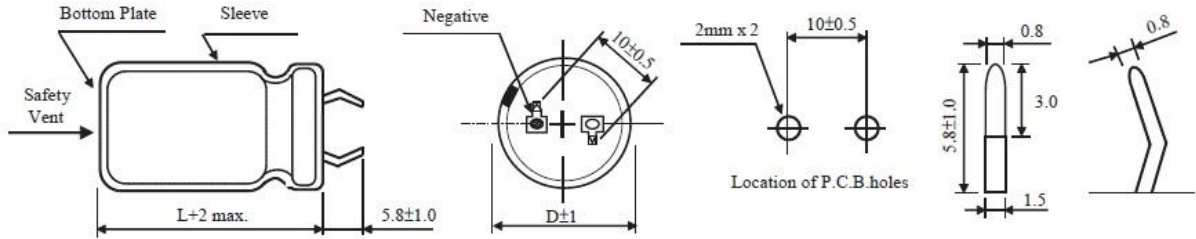

Standard Ratings

DxL (mm); R.C. (A rms) at 105°C 120Hz.

| Cap (µF) | V Item | 16 | | 25 | | 35 | | 50 | | 63 | | 80 | | 100 | |
|-------------|-----------|-------|-------|-------|-------|-------|-------|-------|-------|-------|-------|-------|-------|-------|------|
| | | D x L | R.C. | D x L | R.C. | D x L | R.C. | D x L | R.C. | D x L | R.C. | D x L | R.C. | D x L | R.C. |
| 560 | | | | | | | | | | | | | | 20x25 | 0.95 |
| 680 | | | | | | | | | | | | | | 20x30 | 1.15 |
| 820 | | | | | | | | | | | | 20x25 | 1.04 | 20x35 | 1.32 |
| 1000 | | | | | | | | | | 20x25 | 1.35 | 20x30 | 1.24 | 20x35 | 1.47 |
| 1500 | | | | | | | | 20x25 | 1.02 | 20x30 | 1.47 | 20x35 | 1.59 | 22x40 | 1.98 |
| 2200 | | | | | | | | 20x30 | 1.60 | 20x40 | 1.82 | 22x40 | 2.03 | 25x45 | 2.55 |
| 2700 | | | | | | 20x25 | 1.29 | 20x35 | 1.73 | 22x35 | 2.11 | 22x45 | 2.39 | 25x50 | 2.89 |
| 3300 | | | | | | 20x30 | 1.57 | 20x40 | 1.97 | 22x45 | 2.33 | 25x40 | 2.64 | 30x45 | 3.30 |
| 3900 | | | | 20x25 | 1.65 | 22x25 | 1.78 | 22x40 | 2.22 | 22x50 | 2.55 | 25x50 | 2.97 | 30x50 | 3.67 |
| 4700 | | | | 20x25 | 1.75 | 20x35 | 2.02 | 22x45 | 2.43 | 25x45 | 2.97 | 30x40 | 3.38 | 35x45 | 3.80 |
| 6800 | 20x25 | 1.50 | 20x35 | 2.11 | 22x40 | 2.41 | 25x45 | 3.30 | 30x40 | 3.65 | 35x45 | 4.10 | 35x50 | 4.05 | |
| 8200 | 20x30 | 1.70 | 20x40 | 2.34 | 22x45 | 2.85 | 25x50 | 3.60 | 30x50 | 4.04 | 35x50 | 4.30 | | | |
| 10000 | 20x35 | 1.85 | 22x35 | 2.65 | 22x50 | 3.05 | 30x45 | 4.05 | 35x45 | 4.48 | | | | | |
| 12000 | 20x40 | 2.01 | 22x40 | 2.81 | 25x45 | 3.37 | 30x50 | 4.56 | 35x50 | 4.75 | | | | | |
| 15000 | 22x35 | 2.39 | 22x45 | 3.13 | 25x50 | 3.72 | 35x50 | 4.77 | | | | | | | |
| 18000 | 22x40 | 2.90 | 25x40 | 3.56 | 30x45 | 4.37 | | | | | | | | | |
| 22000 | 22x45 | 3.10 | 25x50 | 4.04 | 30x50 | 4.92 | | | | | | | | | |
| 27000 | 22x50 | 3.55 | 30x45 | 4.74 | 35x50 | 5.30 | | | | | | | | | |
| 33000 | 25x45 | 4.05 | 30x50 | 5.50 | | | | | | | | | | | |
| 39000 | 25x50 | 4.55 | 35x45 | 5.80 | | | | | | | | | | | |
| 47000 | 30x45 | 5.36 | 35x50 | 6.30 | | | | | | | | | | | |
| 56000 | 30x50 | 5.60 | | | | | | | | | | | | | |

Standard Ratings

DxL (mm); R.C. (A rms) at 105°C 120Hz.

| Cap (µF) | V Item | 160 | | 200 | | 250 | | 350 | | 400 | | 450 | |
|-------------|-----------|----------------|------|----------------|-------|----------------|------|----------------|------|----------------|------|----------------|------|
| | | D x L | R.C. | D x L | R.C. | D x L | R.C. | D x L | R.C. | D x L | R.C. | D x L | R.C. |
| 47 | | | | | | | | | | 22x25 | 0.45 | 22x25 | 0.43 |
| 68 | | | | | | | | | | 22x25 | 0.50 | 22x30 | 0.50 |
| 82 | | | | | | | | 22x30 | 0.55 | 22x25 | 0.65 | 22x30 25x25 | 0.60 |
| 100 | | | | | | | | 22x30 22x25 | 0.60 | 22x30 25x25 | 0.68 | 22x35 25x30 | 0.70 |
| 120 | | | | | | | | 22x30 25x25 | 0.70 | 22x35 25x25 | 0.75 | 22x40 25x30 | 0.78 |
| 150 | | | | | 22x25 | 0.65 | | 22x35 25x30 | 0.83 | 22x40 25x30 | 0.85 | 22x45 25x35 | 0.89 |
| 220 | | 20x25 | 1.10 | 20x25 | 1.00 | 20x30 22x25 | 1.00 | 22x45 25x35 | 1.05 | 22x50 25x40 | 1.05 | 25x45 30x35 | 1.15 |
| 330 | | 20x30 22x25 | 1.21 | 20x30 | 1.25 | 20x40 22x35 | 1.20 | 25x45 30x35 | 1.35 | 30x40 35x30 | 1.35 | 30x50 35x40 | 1.45 |
| 390 | | 20x30 22x25 | 1.30 | 22x30 25x25 | 1.31 | 22x40 25x30 | 1.35 | 25x50 30x40 | 1.52 | 30x45 35x35 | 1.75 | 35x40 | 1.65 |
| 470 | | 20x35 22x30 | 1.41 | 22x35 25x30 | 1.45 | 22x45 25x35 | 1.57 | 30x45 35x35 | 1.65 | 35x40 | 1.85 | 35x50 | 1.85 |
| 560 | | 20x40 22x35 | 1.54 | 22x40 25x30 | 1.60 | 22x50 25x40 | 1.80 | 30x50 35x40 | 1.90 | 35x45 | 2.05 | | |
| 680 | | 20x45 22x40 | 1.74 | 22x45 25x35 | 1.78 | 25x45 30x35 | 2.00 | 35x45 | 2.00 | 35x50 | 2.45 | | |
| 820 | | 20x45 25x35 | 2.00 | 22x50 25x40 | 1.95 | 25x50 30x40 | 2.18 | 35x55 | 2.30 | | | | |
| 1000 | | 22x50 25x40 | 2.25 | 25x45 30x35 | 2.30 | 30x45 35x35 | 2.35 | | | | | | |
| 1200 | | 25x45 30x35 | 2.49 | 30x40 35x35 | 2.65 | 35x40 | 2.50 | | | | | | |
| 1500 | | 30x40 35x30 | 2.84 | 30x50 35x40 | 3.08 | 35x50 | 3.00 | | | | | | |
| 2200 | | 35x45 | 3.50 | 35x50 | 3.55 | | | | | | | | |
| 2700 | | 35x50 | 4.00 | | | | | | | | | | |

SIE Series

- 105°C 5000 hours, long life.
- High temperature, high ripple current resistance and high reliability.
- RoHS Compliant.

Specifications

| Items | Characteristics | | | | | | | | | | | |
|--|---|---|----|------|------|-----|--------------|----------|-----------|-----------|----------|------|
| Capacitance Tolerance | ± 20% (120Hz, 20°C) | | | | | | | | | | | |
| Operating Temperature Range | -40 ~ +105°C | | | | | | -25 ~ +105°C | | | | | |
| Rated Voltage Range | 10 ~ 100VDC | | | | | | 160 ~ 450VDC | | | | | |
| Leakage Current | $I \leq 3VCV$ (μA) (After 5 minutes application of DC rated voltage, at 20°C) | | | | | | | | | | | |
| Dissipation Factor | Measurement Frequency: 120Hz. Temperature: 20°C | | | | | | | | | | | |
| | Rated Voltage (V) | 10 | 16 | 25 | 35 | 50 | 63 | 80 ~ 100 | 160 ~ | 410 | 420~ 450 | 550 |
| | tan δ(Max) | 0.60 | 0. | 0.30 | 0.25 | 0.2 | 0.15 | 0.15 | 0.15 | 0.20 | 0.20 | 0.20 |
| When nominal capacitance over 1000μF, tan δ shall be added 0.01 to the listed value with increase of every 1000μF. | | | | | | | | | | | | |
| Low Temperature Stability Impedance Ratio (Max) | Measurement Frequency: 120Hz. | | | | | | | | | | | |
| | Rated Voltage(V) | 10 | 16 | 25 | 35 | 50 | 63 | 80 ~ 100 | 160 ~ 400 | 420 ~ 450 | | |
| | Z(-25°C) / Z(20°C) | 4 | 4 | 3 | 3 | 2 | 2 | 2 | 4 | 8 | | |
| | Z(-40°C) / Z(20°C) | 15 | 15 | 10 | 8 | 6 | 6 | 5 | - | - | | |
| Load Life | 5,000 hours, with application of rated voltage at 105°C | | | | | | | | | | | |
| | Capacitance Change | Within ± 20% of Initial Value | | | | | | | | | | |
| | tan δ | 200% or less of Initial Specified Value | | | | | | | | | | |
| | Leakage Current | Initial Specified Value or less | | | | | | | | | | |
| Shelf Life | The following specifications shall be satisfied when the capacitors are restored to 20°C after exposing them for 1,000 hours 105°C without voltage applied. Before the measurement, the capacitor shall be preconditioned by applying voltage according to them 4.1 of JIS C5101-4. | | | | | | | | | | | |
| | Capacitance Change | Within ± 15% of Initial Value | | | | | | | | | | |
| | tan δ | 200% or less of Initial Specified Value | | | | | | | | | | |
| | Leakage Current | Initial Specified Value or less | | | | | | | | | | |
| Standards | JIS C-5101-4 (IEC 60384) | | | | | | | | | | | |

Frequency Coefficient for Ripple Current

| Rated Voltage (V) | Frequency (Hz) | | | | |
|-------------------|----------------|------|------|------|------|
| | 50 | 120 | 1K | 10K | 50K |
| 10 ~ 100 | 0.90 | 1.00 | 1.05 | 1.10 | 1.15 |
| 160 ~ 250 | 0.80 | 1.00 | 1.15 | 1.45 | 1.50 |
| 315 ~ 450 | 0.76 | 1.00 | 1.14 | 1.40 | 1.42 |

The endurance of capacitors is reduced with internal heating produced by ripple current at the rate of halving the lifetime with every 5°C rise. When long life performance is required in actual use, the rms ripple current has to be reduced.

SIE Series

Dimensions (mm)

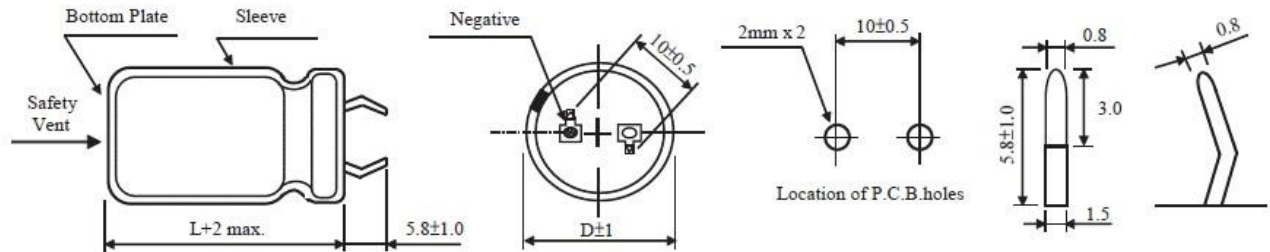

Standard Ratings

DxL (mm); R.C. (A rms) at 105°C 120Hz

| Cap (µF) | V | 10 | | 16 | | 25 | | 35 | | 50 | |
|----------|-------|-------|------|-------|-------|-------|-------|-------|-------|-------|------|
| | | D x L | R.C. | D x L | R.C. | D x L | R.C. | D x L | R.C. | D x L | R.C. |
| 1500 | | | | | | | | | | 22x25 | 1.02 |
| 1800 | | | | | | | | | | 22x30 | 1.18 |
| | | | | | | | | | | 25x25 | 1.17 |
| 2200 | | | | | | | | 22x25 | 1.11 | 22x35 | 1.32 |
| 2700 | | | | | | | | | | 22x40 | 1.51 |
| | | | | | | | | | | 25x30 | 1.48 |
| | | | | | | | | | | 30x25 | 1.51 |
| 3300 | | | | | | | | 22x30 | 1.42 | 25x35 | 1.71 |
| | | | | | | | | 25x25 | 1.41 | 30x30 | 1.72 |
| | | | | | | | | | | 35x25 | 1.74 |
| 3900 | | | | | | 22x25 | 1.32 | 22x35 | 1.58 | 22x50 | 1.91 |
| | | | | | | | | 25x30 | 1.59 | 25x40 | 1.89 |
| 4700 | | | | | | 22x30 | 1.51 | 22x40 | 1.78 | 30x35 | 2.12 |
| | | | | | | 25x25 | 1.52 | 30x25 | 1.78 | 35x30 | 2.16 |
| 5600 | | | | | | | | 25x35 | 1.98 | 25x50 | 2.39 |
| | | | | 22x25 | 1.45 | 22x35 | 1.71 | 30x30 | 1.99 | 30x40 | 2.39 |
| | | | | | | | | 35x25 | 2.03 | 35x35 | 2.41 |
| 6800 | | 22x25 | 1.31 | 22x30 | 1.67 | 22x40 | 1.92 | 22x50 | 2.26 | 30x50 | 2.79 |
| | 25x25 | | | 1.66 | 25x30 | 1.88 | 25x40 | 2.25 | 35x40 | 2.79 | |
| | 30x25 | | | 1.90 | 30x35 | 2.15 | 25x50 | 2.57 | | | |
| 8200 | | | | 22x35 | 1.88 | 30x30 | 2.16 | 30x35 | 2.51 | | |
| | | | | | | 35x25 | 2.19 | 35x30 | 2.56 | | |
| | | | | | | | | | | | |
| 10000 | | 22x30 | 1.65 | 22x40 | 2.12 | 22x50 | 2.45 | 30x40 | 2.87 | | |
| | | 25x25 | 1.63 | 25x30 | 2.08 | 25x40 | 2.44 | 35x35 | 2.88 | 35x50 | 3.56 |
| | | | | 30x25 | 2.12 | | | | | | |

SIE Series

DxL(mm) ; R.C.(A rms) at 105°C 120Hz

| Cap (µF) | V | 10 | | 16 | | 25 | | 35 | | 50 | |
|----------|------|-------|------|-------|------|-------|------|-------|------|-------|------|
| | Item | D x L | R.C. | D x L | R.C. | D x L | R.C. | D x L | R.C. | D x L | R.C. |
| 12000 | | 22x35 | 1.84 | 25x35 | 2.38 | 25x50 | 2.78 | 30x50 | 3.32 | | |
| | | 25x30 | 1.85 | 30x30 | 2.37 | 30x35 | 2.71 | | | | |
| | | 30x25 | 1.88 | 35x25 | 2.41 | 35x30 | 2.76 | 35x40 | 3.31 | | |
| 15000 | | 22x40 | 2.11 | 22x50 | 2.74 | 30x40 | 3.14 | | | | |
| | | 25x35 | 2.15 | 25x40 | 2.72 | 35x35 | 3.16 | | | | |
| 18000 | | 22x50 | 2.45 | 25x50 | 3.12 | 30x50 | 3.63 | 35x50 | 4.28 | | |
| | | 25x40 | 2.42 | | | | | | | | |
| | | 30x30 | 2.38 | 35x40 | 3.62 | | | | | | |
| | | 35x25 | 2.41 | | | 35x30 | 3.09 | | | | |
| 22000 | | 30x35 | 2.72 | 30x40 | 3.47 | | | | | | |
| | | 35x30 | 2.78 | 35x35 | 3.49 | | | | | | |
| 27000 | | 25x50 | 3.12 | 30x50 | 4.07 | 35x50 | 4.72 | | | | |
| | | 30x40 | 3.14 | 35x40 | 4.05 | | | | | | |
| 33000 | | 35x35 | 3.48 | | | | | | | | |
| 39000 | | 30x50 | 3.98 | 35x50 | 5.15 | | | | | | |
| | | 35x40 | 3.95 | | | | | | | | |
| 47000 | | 35x50 | 4.62 | | | | | | | | |

SIE Series

Standard Ratings

DxL (mm) ; R.C.(A rms) at 105°C 120Hz.

| Cap (µF) | V | 63 | | 80 | | 100 | | 160 | | 180 | |
|----------|------|-------|------|-------|------|-------|------|-------|------|-------|------|
| | Item | D x L | R.C. | D x L | R.C. | D x L | R.C. | D x L | R.C. | D x L | R.C. |
| 330 | | | | | | | | | | 22x25 | 1.22 |
| 390 | | | | | | 22x25 | 0.78 | 22x25 | 1.32 | | |
| 470 | | | | | | | | | | 22x30 | 1.53 |
| | | | | | | | | | | 25x25 | 1.52 |
| 560 | | | | | | 22x30 | 0.99 | 22x30 | 1.66 | 22x35 | 1.70 |
| | | | | | | 25x25 | 0.98 | 25x25 | 1.67 | 30x25 | 1.78 |
| 680 | | | | 22x25 | 0.97 | 22x35 | 1.12 | 22x35 | 1.87 | 22x40 | 1.91 |
| | | | | | | | | 25x30 | 1.89 | 25x30 | 1.89 |
| | | | | | | | | 30x25 | 1.95 | | |
| 820 | | | | 22x30 | 1.12 | 22x40 | 1.26 | 22x40 | 2.09 | 22x45 | 1.99 |
| | | | | | | 25x30 | 1.24 | | | 25x35 | 2.16 |
| | | | | | | 30x25 | 1.25 | | | 30x30 | 2.17 |
| | | | | | | | | | | 35x25 | 2.31 |
| 1000 | | 22x25 | 1.00 | 22x35 | 1.26 | 25x35 | 1.41 | 22x45 | 2.41 | 22x50 | 2.25 |
| | | | | 25x25 | 1.24 | 30x30 | 1.42 | 25x40 | 2.38 | 25x45 | 2.47 |
| | | | | | | 35x25 | 1.44 | 30x30 | 2.39 | | |
| | | | | | | | | 35x30 | 2.53 | 30x35 | 2.46 |
| 1200 | | 22x30 | 1.16 | 22x40 | 1.42 | 22x50 | 1.60 | 25x45 | 2.71 | 25x50 | 2.76 |
| | | 25x25 | 1.15 | 25x30 | 1.40 | 25x40 | 1.59 | 30x40 | 2.76 | 30x40 | 2.77 |
| | | | | 30x25 | 1.41 | 30x35 | 1.61 | 35x30 | 2.85 | 35x35 | 2.85 |
| 1500 | | 22x35 | 1.32 | 25x35 | 1.62 | 25x50 | 1.86 | 25x50 | 3.09 | 30x45 | 3.17 |
| | | | | | | 30x40 | 1.87 | 30x45 | 3.16 | 30x50 | 3.20 |
| | | | | | | 35x30 | 1.85 | 35x40 | 3.21 | 35x35 | 3.22 |
| 1800 | | 22x40 | 1.49 | 22x50 | 1.84 | 35x35 | 2.06 | 30x50 | 3.53 | 35x45 | 3.73 |
| | | 25x30 | 1.46 | 25x40 | 1.83 | | | | | | |
| | | 30x25 | 1.48 | 30x30 | 1.79 | | | | | | |
| | | | | 35x25 | 1.82 | | | | | | |
| 2200 | | 25x35 | 1.67 | 25x50 | 2.10 | 30x50 | 2.40 | 35x50 | 4.14 | 35x50 | 4.23 |
| | | 30x30 | 1.68 | 30x35 | 2.06 | | | | | | |
| | | 35x25 | 1.70 | 35x25 | 2.09 | 35x40 | 2.39 | | | | |
| 2700 | | 22x50 | 1.92 | 30x40 | 2.35 | 35x50 | 2.81 | | | | |
| | | 25x40 | 1.91 | | | | | | | | |
| | | 30x35 | 1.93 | 35x35 | 2.36 | | | | | | |
| 3300 | | 25x50 | 2.20 | 30x50 | 2.75 | | | | | | |
| | | 35x30 | 2.18 | 35x40 | 2.73 | | | | | | |
| 3900 | | 30x40 | 2.41 | | | | | | | | |
| | | 35x35 | 2.43 | | | | | | | | |
| 4700 | | 30x50 | 2.79 | 35x50 | 3.46 | | | | | | |
| | | 35x40 | 2.78 | | | | | | | | |
| 6800 | | 35x50 | 3.55 | | | | | | | | |

SIE Series

Standard Ratings

DxL (mm); R.C. (A rms) at 105°C 120Hz.

| Cap (µF) | V Item | 200 | | 220 | | 250 | | 315 | |
|----------|--------|-------|------|-------|------|-------|------|-------|------|
| | | D x L | R.C. | D x L | R.C. | D x L | R.C. | D x L | R.C. |
| 150 | | | | | | | | 22x25 | 0.80 |
| | | | | | | | | 22x30 | 0.93 |
| 180 | | | | | | | | 25x25 | 0.94 |
| | | | | | | | | 22x35 | 1.04 |
| 220 | | 22x25 | 1.00 | | | 22x25 | 1.01 | 25x25 | 1.16 |
| | | | | | | | | 22x40 | 1.18 |
| 270 | | 22x25 | 1.11 | 22x25 | 1.11 | 22x30 | 1.20 | 25x30 | 1.19 |
| | | | | | | | | 22x45 | 1.33 |
| 330 | | | | 22x30 | 1.18 | 25x30 | 1.32 | 25x35 | 1.37 |
| | | | | | | | | 30x30 | 1.40 |
| | | | | | | | | 35x25 | 1.48 |
| | | | | | | | | 22x50 | 1.49 |
| 390 | | 22x30 | 1.38 | 22x35 | 1.39 | 22x40 | 1.44 | 25x40 | 1.52 |
| | | 25x25 | 1.39 | 25x25 | 1.39 | 25x30 | 1.43 | 30x25 | 1.50 |
| | | | | | | | | 22x45 | 1.62 |
| 470 | | 22x35 | 1.55 | 22x35 | 1.55 | 25x35 | 1.70 | 25x45 | 1.70 |
| | | | | 25x30 | 1.56 | 30x35 | 1.74 | 30x35 | 1.71 |
| | | | | 30x25 | 1.62 | 30x30 | 1.74 | 35x30 | 1.81 |
| 560 | | 22x40 | 1.73 | 22x45 | 1.73 | 22x50 | 1.84 | 25x50 | 1.88 |
| | | 25x30 | 1.72 | 25x35 | 1.81 | 25x40 | 1.78 | 30x40 | 1.92 |
| | | | | | | 30x35 | 1.83 | 30x45 | 1.97 |
| | | | | | | 35x25 | 1.90 | 35x35 | 1.99 |
| | | | | | | | | | |
| 680 | | 22x45 | 1.82 | 22x50 | 1.98 | 25x45 | 2.04 | 30x50 | 2.21 |
| | | 25x35 | 1.86 | 25x40 | 1.96 | 30x40 | 2.06 | | |
| | | 30x30 | 1.97 | 30x35 | 2.02 | 35x30 | 2.14 | 35x40 | 2.28 |
| | | 35x25 | 2.09 | 35x25 | 2.09 | | | | |
| | | 25x50 | 2.17 | 25x45 | 2.24 | 25x50 | 2.28 | | |
| 820 | | 25x40 | 2.09 | 30x40 | 2.29 | 30x45 | 2.38 | 35x45 | 2.57 |
| | | 30x35 | 2.21 | 35x30 | 2.35 | 35x35 | 2.37 | | |
| | | | | | | | | | |
| 1000 | | 25x50 | 2.39 | 25x55 | 2.52 | 30x50 | 2.68 | 35x50 | 2.89 |
| | | 30x40 | 2.53 | 30x45 | 2.58 | 35x40 | 2.71 | | |
| | | 35x30 | 2.60 | 35x35 | 2.63 | | | | |
| 1200 | | 30x45 | 2.85 | 30x50 | 2.89 | 35x45 | 3.05 | | |
| | | 35x40 | 2.88 | 35x40 | 2.97 | | | | |
| 1500 | | 35x45 | 3.34 | 35x45 | 3.41 | 35x50 | 3.49 | | |
| 1800 | | 35x50 | 3.82 | 35x50 | 3.82 | | | | |

SIE Series

Standard Ratings

DxL (mm); R.C. (A rms) at 105°C 120Hz.

| Cap (µF) | V | 350 | | 400 | | 420 | | 450 | |
|----------|------|-------|------|-------|------|-------|-------|-------|------|
| | Item | D x L | R.C. | D x L | R.C. | D x L | R.C. | D x L | R.C. |
| 82 | | | | | | | | 22x25 | 0.60 |
| 100 | | | | 22x25 | 0.66 | 22x25 | 0.66 | 22x30 | 0.69 |
| | | | | | | | | 25x25 | 0.70 |
| 120 | | 22x25 | 0.72 | 22x30 | 0.75 | 22x30 | 0.76 | 22x35 | 0.76 |
| | | | | | | 25x25 | 0.77 | | |
| 150 | | 22x30 | 0.84 | 22x35 | 0.85 | 22x35 | 0.86 | 22x45 | 0.90 |
| | | | | 25x25 | 0.86 | | | 25x35 | 0.92 |
| | | | | | | | | 30x25 | 0.93 |
| 180 | | 25x25 | 0.94 | 22x40 | 0.96 | 22x45 | 0.98 | 22x50 | 1.01 |
| | | | | 25x30 | 0.97 | 25x35 | 1.01 | 25x40 | 1.02 |
| | | | | 30x25 | 1.03 | 30x25 | 1.02 | 30x30 | 1.03 |
| | | | | | | | 35x25 | 1.09 | |
| 220 | | 22x40 | 1.06 | 22x45 | 1.09 | 22x50 | 1.11 | 25x45 | 1.16 |
| | | 25x30 | 1.07 | 25x35 | 1.12 | 25x40 | 1.13 | 30x35 | 1.17 |
| | | 30x25 | 1.12 | 35x25 | 1.21 | 30x30 | 1.14 | 35x30 | 1.23 |
| | | | | | | 35x25 | 1.21 | | |
| 270 | | 22x45 | 1.21 | 22x50 | 1.24 | 25x45 | 1.29 | 25x50 | 1.31 |
| | | 25x35 | 1.24 | | | 30x35 | 1.30 | 30x40 | 1.33 |
| | | 30x30 | 1.27 | 30x35 | 1.27 | 35x30 | 1.37 | 35x35 | 1.38 |
| | | 35x25 | 1.34 | | | | | | |
| 330 | | 22x50 | 1.37 | 25x50 | 1.44 | 25x50 | 1.45 | 30x45 | 1.51 |
| | | 25x40 | 1.39 | 30x35 | 1.43 | 30x40 | 1.48 | | |
| | | 30x35 | 1.42 | 35x30 | 1.51 | 35x35 | 1.54 | | |
| 390 | | 25x45 | 1.55 | 30x40 | 1.61 | 30x45 | 1.65 | 30x50 | 1.67 |
| | | 30x40 | 1.59 | 35x35 | 1.66 | 35x40 | 1.73 | 35x45 | 1.76 |
| | | 35x30 | 1.65 | | | | | | |
| 470 | | 25x50 | 1.73 | 30x50 | 1.85 | 30x50 | 1.85 | 35x50 | 1.98 |
| | | 30x45 | 1.81 | 35x40 | 1.89 | 35x45 | 1.93 | | |
| | | 35x35 | 1.82 | | | | | | |
| 560 | | 30x50 | 2.01 | 35x45 | 2.13 | 35x50 | 2.17 | | |
| | | 35x40 | 2.06 | | | | | | |
| 680 | | 35x45 | 2.34 | 35x50 | 2.38 | | | | |
| 820 | | 35x50 | 2.62 | | | | | | |

SIF Series

- Protective countermeasure against DC over-voltage
- 105°C 2000 hours load life.
- RoHS Compliant.

Specifications

| Items | Characteristics | | | |
|---|--|---|----------|------|
| Capacitance Tolerance | ± 20% (120Hz, 20°C) | | | |
| Operating Temperature Range | -25 ~ +105°C | | | |
| Rated Voltage Range | 200VDC, 400VDC, 420VDC | | | |
| Leakage Current | $I \leq 3 \text{ VCV} (\mu\text{A})$ (After 5 minutes application of DC rated voltage, at 20°C) | | | |
| Dissipation Factor | Measurement Frequency: 120Hz. Temperature: 20°C | | | |
| | Rated Voltage (V) | 200 | 400 | 420 |
| | tan δ (Max) | 0.15 | 0.15 | 0.15 |
| Low Temperature Stability Impedance Ratio (Max) | Measurement Frequency: 120Hz. | | | |
| | Rated Voltage(V) | 200 | 400, 420 | |
| | Z(-25°C) / Z(20°C) | 3 | 8 | |
| Load Life | 2,000 hours, with application of rated voltage at 105°C | | | |
| | Capacitance Change | Within ± 20% of Initial Value | | |
| | tan δ | 200% or less of Initial Specified Value | | |
| | Leakage Current | Initial Specified Value or less | | |
| Shelf Life | The following specifications shall be satisfied when the capacitors are restored to 20°C after exposing them for 1,000 hours 105°C without voltage applied. Before the measurement the capacitor shall be preconditioned by applying voltage according to them 4.1 of JIS C5101-4. | | | |
| | Capacitance Change | Within ± 15% of Initial Value | | |
| | tan δ | ≤150% of Initial Specified Value | | |
| | Leakage Current | Initial Specified Value or less | | |
| Standards | JIS C-5101-4(IEC 60384) | | | |

DC over voltage test conditions

The vent will be operated, and the capacitor shall become an open circuit without burning materials when the following excess DC voltage is applied.

TEST DC VOLTAGE

| Rated Voltage (Vdc) | Current Limit (A) | Test DC Voltage |
|---------------------|-------------------|-----------------|
| 200 Vdc | 1A | 375V |
| 400 Vdc | 1A | 600V |
| 420 Vdc | 1A | 630V |
| 450 Vdc | 1A | 675V |

TEST CIRCUIT

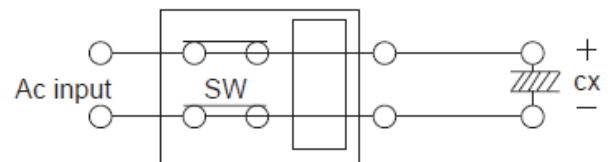

Frequency Coefficient for Ripple Current

| Rated Voltage (V) | Frequency (Hz) | | | | | |
|-------------------|----------------|------|------|------|------|-------|
| | 50 | 60 | 120 | 500 | 1K | ≥ 10K |
| 200 | 0.80 | 0.80 | 1.00 | 1.10 | 1.14 | 1.18 |
| 400, 420 | 0.80 | 0.80 | 1.00 | 1.05 | 1.10 | 1.15 |

The endurance of capacitors is reduced with internal heating produced by ripple current at the rate of halving the lifetime with every 5°C rise. When long life performance is required in actual use, the RMS ripple current has to be reduced.

SIF Series

Dimensions (mm)

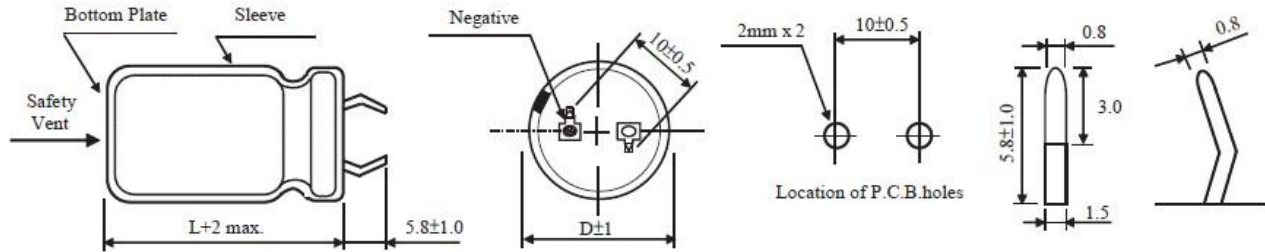

Standard Ratings

DxL(mm) ; R.C.(A rms) at 105°C 120Hz.

| Cap (µF) | V | | 200 | | 400 | | 420 | |
|----------|-------|-------|-------|-------|------|-------|-------|------|
| | Item | D x L | R.C. | D x L | R.C. | D x L | R.C. | |
| 33 | | | | 22x20 | 0.22 | 22x25 | 0.25 | |
| 39 | | | | 22x20 | 0.30 | | | |
| 47 | 22x20 | 0.35 | | 22x25 | 0.35 | d | 22x25 | 0.35 |
| | | | | 25x20 | 0.35 | | | |
| | | | | 30x20 | 0.40 | | | |
| 56 | | | | 22x25 | 0.38 | 22x25 | 0.38 | |
| | | | | 25x20 | 0.38 | | | |
| 68 | | | | 22x25 | 0.40 | 22x30 | 0.45 | |
| | | | | 25x25 | 0.45 | | | |
| | | | | 30x20 | 0.50 | | | |
| 82 | | | | 22x30 | 0.50 | 22x35 | 0.64 | |
| | | | | 25x25 | 0.50 | | | |
| | | | | 30x20 | 0.50 | | | |
| 100 | 22x20 | 0.50 | | 22x35 | 0.55 | 22x40 | 0.69 | |
| | | | | 25x30 | 0.53 | | | |
| | | | | 30x25 | 0.53 | | | |
| | | | | 35x20 | 0.55 | | | |
| 120 | | | | 22x40 | 0.60 | 22x45 | 0.75 | |
| | | | | 25x30 | 0.60 | | | |
| | | | | 30x25 | 0.60 | | | |
| | | | | 35x25 | 0.75 | | | |
| 150 | | | | 22x45 | 0.70 | 25x40 | 0.82 | |
| | | | | 25x35 | 0.70 | | | |
| | | | | 30x30 | 0.70 | | | |
| | | | | 35x25 | 0.70 | | | |
| 180 | 22x25 | 0.70 | | 22x50 | 0.80 | 25x45 | 0.90 | |
| | | | | 25x40 | 0.80 | | | |
| | 30x20 | 0.70 | | 30x30 | 0.80 | 30x35 | 0.90 | |
| | | | 35x25 | 0.80 | | | | |
| 220 | 22x25 | 0.74 | | 25x45 | 0.90 | 30x40 | 1.00 | |
| | | | | 30x35 | 0.90 | | | |
| | | | | 35x30 | 0.90 | | | |

SIF Series

Standard Ratings

DxL(mm) ; R.C.(A rms) at 105°C 120Hz.

| Cap (µF) | V | 200 | | 400 | | 420 | |
|----------|------|-------|------|-------|------|-------|------|
| | Item | D x L | R.C. | D x L | R.C. | D x L | R.C. |
| 270 | | 22x30 | 0.90 | 30x40 | 0.98 | 30x45 | 1.10 |
| | | 25x25 | 0.85 | | | | |
| | | 30x20 | 1.10 | 35x35 | 0.96 | 35x40 | 1.10 |
| 330 | | 22x30 | 1.05 | 30x50 | 1.21 | 35x45 | 1.20 |
| | | 25x30 | 1.05 | | | | |
| | | 30x25 | 1.05 | 35x40 | 1.21 | | |
| 390 | | 22x35 | 1.20 | 35x45 | 1.32 | | |
| | | 25x30 | 1.20 | | | | |
| | | 30x25 | 1.20 | | | | |
| 470 | | 22x40 | 1.30 | 35x50 | 1.45 | | |
| | | 25x35 | 1.30 | | | | |
| | | 30x25 | 1.35 | | | | |
| 560 | | 22x45 | 1.50 | | | | |
| | | 25x40 | 1.50 | | | | |
| | | 30x35 | 1.55 | | | | |
| | | 35x25 | 1.55 | | | | |
| 680 | | 25x50 | 1.70 | | | | |
| | | 30x40 | 1.70 | | | | |
| | | 35x30 | 1.70 | | | | |
| 820 | | 30x45 | 1.99 | | | | |
| | | 35x35 | 1.99 | | | | |
| 1000 | | 30x50 | 2.10 | | | | |
| | | 35x40 | 2.10 | | | | |
| 1200 | | 35x50 | 2.30 | | | | |

SIH Series

- Long life of SIA Series
- Suitable for filter circuit of home appliance, e.g.TV set, audio, etc.
- RoHS Compliance.

Specifications

| Items | Characteristics | | | | | | | | |
|-----------------------------|--|---|------|------|-------------|--------|-----------|---------|---------|
| Capacitance Tolerance | ± 20% (120Hz, 20°C) | | | | | | | | |
| Operating Temperature Range | -40~ +85°C | | | | -25~ +85°C | | | | |
| Rated Voltage Range | 10~ 100VDC | | | | 160~ 550VDC | | | | |
| Leakage Current | $I \leq 3VCV$ (μA) (After 5 minutes application of DC rated voltage, at 20°C) | | | | | | | | |
| Dissipation Factor | Measurement Frequency: 120Hz. Temperature: 20°C | | | | | | | | |
| | Rated Voltage(V) | 10 | 16 | 25 | 35 | 50~100 | 135 | 160~250 | 330~500 |
| | tan δ | 0.50 | 0.40 | 0.35 | 0.30 | 0.25 | 0.25 | 0.20 | 0.25 |
| | When the nominal capacitance over 1000μF, tan δ shall be added 0.01 to the listed value with increase of every 1000μF. | | | | | | | | |
| Low Temperature Stability | Measurement Frequency: 120Hz. | | | | | | | | |
| | Rated Voltage(V) | 10 ~ 100 | | | 160 ~ 250 | | 330 ~ 500 | | |
| | Z(-25°C) / Z(20°C) | 4 | | | 4 | | 8 | | |
| | Z(-40°C) / Z(20°C) | 12 | | | 15 | | - | | |
| Load Life | 3000 hours, with application of rated voltage at 85°C | | | | | | | | |
| | Capacitance Change | Within ± 20% of Initial Value (Within ±25% for 4V) | | | | | | | |
| | tan δ | 200% or less of Initial Specified Value | | | | | | | |
| | Leakage Current | Initial Specified Value or less | | | | | | | |
| Shelf Life | The following specifications shall be satisfied when the capacitors are restored to 20°C after exposing them for 1,000 hours 85°C without voltage applied. Before the measurement, the capacitor shall be preconditioned by applying voltage according to them 4.1 of JIS C5101-4. | | | | | | | | |
| | Capacitance Change | Within ± 20% of Initial Value | | | | | | | |
| | tan δ | 150% or less of Initial Specified Value | | | | | | | |
| | Leakage Current | Initial Specified Value or less | | | | | | | |
| Standard | JIS C 5101-4- 1 (IEC 60384) | | | | | | | | |

Frequency Coefficient of Permissible Ripple Current

| Rated Voltage (V) | Frequency (HZ) | | | |
|-------------------|----------------|------|------|------|
| | 50 | 120 | 1K | ≥10K |
| 10 ~ 100 | 0.88 | 1.00 | 1.15 | 1.15 |
| 160 ~ 250 | 0.85 | 1.00 | 1.15 | 1.20 |
| 330 ~ 550 | 0.88 | 1.00 | 1.10 | 1.15 |

The endurance of capacitors is reduced with internal heating produced by ripple current at the rate of halving the lifetime with every 10°C rise. When long life performance is required in actual use, the rms ripple current has to be reduced.

SIH Series

Dimensions (mm)

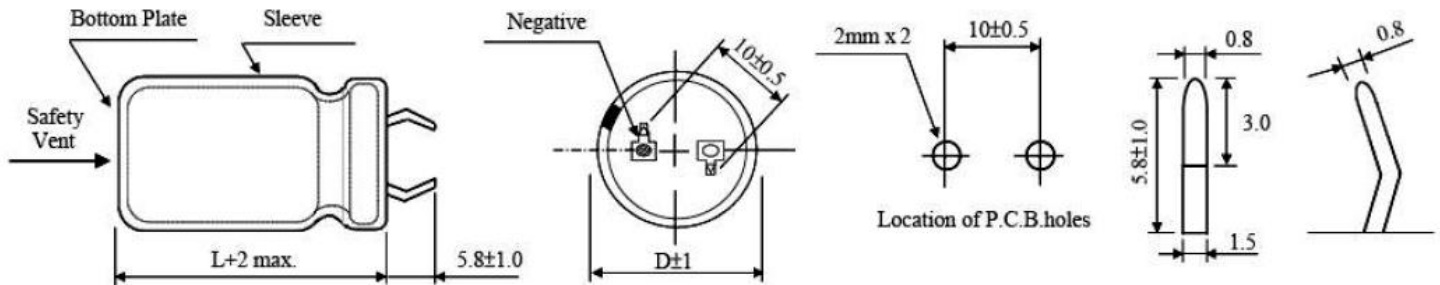

Standard Ratings

DxL (mm); R.C. (A rms) at 85°C 120Hz

| Cap (μF) | V Item | 10 | | 16 | | 25 | | 35 | | 50 | | 63 | | 80 | |
|--------------------------|-----------|----------------|------|----------------|-------|----------------|------|----------------|------|----------------|------|----------------|------|----------------|------|
| | | DxL | R.C. | DxL | R.C. | DxL | R.C. | DxL | R.C. | DxL | R.C. | DxL | R.C. | DxL | R.C. |
| 820 | | | | | | | | | | | | | | 22x25 | 1.35 |
| 1000 | | | | | | | | | | | | 22x25 | 1.54 | 22x25 | 1.66 |
| 1500 | | | | | | | | | | | | 22x25 | 1.70 | 22x30 25x25 | 1.82 |
| 2200 | | | | | | | | | | 22x25 | 2.10 | 22x30 25x25 | 2.61 | 22x35 25x30 | 2.68 |
| 2700 | | | | | | | | | | 22x30 | 2.34 | 22x35 25x30 | 2.83 | 22x40 25x30 | 2.85 |
| 3300 | | | | | | | | | | 22x30 25x25 | 2.68 | 22x40 25x30 | 2.91 | 22x45 25x40 | 3.33 |
| 3900 | | | | | | | | 22x25 | 2.46 | 22x35 25x30 | 2.75 | 22x45 25x35 | 3.18 | 25x45 30x35 | 3.43 |
| 4700 | | | | | | 22x25 | 2.51 | 22x30 25x25 | 2.67 | 22x40 25x35 | 3.12 | 22x50 25x40 | 3.42 | 25x50 30x40 | 3.66 |
| 6800 | | | | 22x25 | 2.42 | 22x30 25x25 | 2.60 | 22x40 25x30 | 2.84 | 22x50 25x40 | 3.90 | 25x50 30x40 | 4.38 | 30x50 35x40 | 4.73 |
| 8200 | | | | 22x25 | 2.93 | 22x35 25x25 | 2.99 | 22x45 25x35 | 3.15 | 25x50 30x40 | 4.46 | 30x45 35x35 | 4.89 | 35x45 | 5.01 |
| 10000 | | 22x25 | 2.10 | 22x30 | 3.11 | 22x40 25x30 | 3.43 | 22x50 25x40 | 3.59 | 25x50 30x40 | 5.03 | 35x40 | 5.57 | 35x50 | 6.14 |
| 12000 | | 22x25 | 2.42 | 22x30 25x25 | 3.54 | 22x45 25x35 | 3.65 | 25x45 30x35 | 4.06 | 30x50 35x35 | 5.21 | 35x50 | 6.28 | | |
| 15000 | | 22x30 | 2.79 | 22x35 25x30 | 3.99 | 25x45 30x35 | 4.14 | 30x40 35x35 | 5.06 | 35x45 | 6.51 | | | | |
| 18000 | | 22x35 25x25 | 3.17 | 22x40 25x35 | 4.44 | 25x45 30x35 | 4.51 | 30x45 35x40 | 5.61 | 35x50 | 6.79 | | | | |
| 22000 | | 22x40 25x30 | 3.57 | 22x50 25x40 | 4.76 | 25x50 30x45 | 5.27 | 35x45 | 6.08 | | | | | | |
| 27000 | | 22x45 25x35 | 4.22 | 25x45 30x35 | 5.57 | 30x50 35x40 | 6.08 | 35x50 | 6.92 | | | | | | |
| 33000 | | 22x50 25x40 | 5.26 | 25x50 30x40 | 5.88 | 35x45 | 6.85 | 35x45 | 7.02 | | | | | | |
| 39000 | | 25x45 30x35 | 5.35 | 30x45 35x35 | 6.42 | 35x45 | 7.68 | 35x50 | 7.23 | | | | | | |
| 47000 | | 30x40 | 6.04 | 30x50 35x40 | 7.06 | 35x50 | 7.96 | | | | | | | | |
| 56000 | | 30x45 | 6.67 | 35x45 | 7.24 | | | | | | | | | | |
| 68000 | | 35x40 | 7.35 | 35x50 | 10.20 | | | | | | | | | | |

Standard Ratings

| Cap (µF) | V Item | 100 | | 160 | | 200 | | 250 | | 350 | | 400 | | 450 | | 500 | |
|-------------|----------------|-------|------|----------------|------|----------------|------|----------------|------|----------------|------|----------------|------|----------------|------|----------------|--------------|
| | | D x l | R.C. | D x l | R.C. | D x l | R.C. | D x l | R.C. | D x l | R.C. | D x l | R.C. | D x l | R.C. | D x l | R.C. |
| 47 | | | | | | | | | | | | 22x25 | 0.42 | 22x25 | 0.46 | 22x35 | 0.47 |
| 100 | | | | | | | | | | 22x25 | 0.78 | 22x30 25x25 | 1.06 | 22x35 25x25 | 1.11 | 25x40 | 1.14 |
| 120 | | | | | | | | | | 22x30 25x25 | 0.94 | 22x35 25x25 | 1.16 | 22x40 25x30 | 1.22 | 25x45 | 1.26 |
| 150 | | | | | | | | 22x25 | 1.11 | 22x35 25x30 | 1.17 | 22x40 25x30 | 1.26 | 22x45 25x35 | 1.45 | 25x50 30x35 | 1.52 1.49 |
| 220 | | | | 22x20 | 1.13 | 22x25 25x20 | 1.38 | 22x30 25x25 | 1.45 | 22x45 25x35 | 1.48 | 22x50 25x40 | 1.78 | 25x45 30x40 | 1.79 | 30x45 | 1.80 |
| 330 | | | | 22x25 25x20 | 1.46 | 22x30 25x25 | 1.90 | 22x35 25x30 | 1.95 | 25x50 30x40 | 2.01 | 30x40 35x30 | 2.32 | 30x45 35x40 | 2.82 | 35x45 | 2.84 |
| 470 | | | | 22x30 25x25 | 1.85 | 22x40 25x30 | 2.27 | 22x45 25x35 | 2.41 | 30x50 35x40 | 2.46 | 35x45 | 2.85 | 35x50 | 2.95 | 35x60 | 3.03 |
| 560 | | | | 22x35 25x30 | 2.05 | 22x40 25x30 | 2.60 | 25x40 30x35 | 2.84 | 35x45 | 3.32 | 35x50 | 3.39 | 35x55 | 3.18 | 35x60 | 3.06 |
| 680 | 22x25 | 1.56 | | 22x35 25x30 | 2.39 | 22x50 25x40 | 2.87 | 25x50 30x40 | 3.25 | 35x50 | 3.47 | 35x50 | 3.54 | 35x60 | 3.39 | 35x70 | 3.30 |
| 820 | 22x25 25x20 | 1.90 | | 22x40 25x35 | 2.78 | 25x45 30x35 | 3.38 | 30x45 35x40 | 3.55 | 35x50 | 3.62 | 35x60 | 3.87 | 35x65 | 3.63 | 40x70 | 3.80 |
| 1000 | 22x30 25x25 | 1.96 | | 25x40 30x35 | 3.25 | 25x50 30x40 | 3.83 | 30x50 35x45 | 3.98 | 35x55 | 3.93 | 35x65 | 4.24 | 35x70 | 3.85 | 45x80 | 4.25 |
| 1200 | 22x30 25x25 | 2.13 | | 25x40 30x35 | 3.44 | 25x50 30x40 | 4.12 | 30x50 35x45 | 4.49 | 35x60 | 4.21 | 35x70 | 4.45 | 40x70 | 4.05 | 45x90 | 4.55 |
| 1500 | 22x35 25x30 | 2.49 | | 30x45 35x35 | 4.00 | 30x50 35x40 | 5.07 | 35x50 | 5.41 | 35x65 | 4.61 | 40x70 | 4.57 | 45x70 | 4.17 | 45x100 | 4.85 |
| 2200 | 22x45 25x40 | 3.18 | | 35x45 | 4.73 | 35x50 | 6.15 | 40x60 | 6.19 | 45x75 | 5.81 | 45x85 | 5.70 | 45x100 | 5.27 | | |
| 2700 | 25x45 30x35 | 3.76 | | 35x50 | 5.40 | | | | | | | | | | | | |
| 3300 | 25x50 30x40 | 4.10 | | | | | | | | | | | | | | | |
| 3900 | 30x45 35x35 | 4.60 | | | | | | | | | | | | | | | |
| 4700 | 30x50 35x40 | 5.17 | | | | | | | | | | | | | | | |
| 6800 | 35x50 | 5.91 | | | | | | | | | | | | | | | |

SIJ Series

- Long life of SIA Series
- Suitable for filter circuit of home appliance, e.g. TV set, audio, etc.
- RoHS Compliance.

Specifications

| Items | Characteristics | | | | | | | |
|-----------------------------|--|---|------|------|-------------|--------|-----------|---------|
| Capacitance Tolerance | ± 20% (120Hz, 20°C) | | | | | | | |
| Operating Temperature Range | -40~ +85°C | | | | -25~ +85°C | | | |
| Rated Voltage Range | 10~ 100VDC | | | | 160~ 550VDC | | | |
| Leakage Current | $I \leq 3VCV$ (μA) (After 5 minutes application of DC rated voltage, at 20°C) | | | | | | | |
| Dissipation Factor | Measurement Frequency: 120Hz. Temperature: 20°C | | | | | | | |
| | Rated Voltage(V) | 10 | 16 | 25 | 35 | 50~100 | 160~250 | 330~500 |
| | tan δ | 0.50 | 0.40 | 0.35 | 0.30 | 0.25 | 0.20 | 0.25 |
| | When the nominal capacitance over 1000μF, tan δ shall be added 0.01 to the listed value with increase of every 1000μF. | | | | | | | |
| Low Temperature Stability | Measurement Frequency: 120Hz. | | | | | | | |
| | Rated Voltage(V) | 10 ~ 100 | | | 160 ~ 250 | | 350 ~ 500 | |
| | Z(-25°C) / Z(20°C) | 4 | | | 4 | | 8 | |
| | Z(-40°C) / Z(20°C) | 12 | | | 15 | | - | |
| Load Life | 5000 hours, with application of rated voltage at 85°C | | | | | | | |
| | Capacitance Change | Within ± 20% of Initial Value (Within ±25% for 4V) | | | | | | |
| | tan δ | 200% or less of Initial Specified Value | | | | | | |
| | Leakage Current | Initial Specified Value or less | | | | | | |
| Shelf Life | The following specifications shall be satisfied when the capacitors are restored to 20°C after exposing them for 1,000 hours 85°C without voltage applied. Before the measurement, the capacitor shall be preconditioned by applying voltage according to them 4.1 of JIS C5101-4. | | | | | | | |
| | Capacitance Change | Within ± 20% of Initial Value | | | | | | |
| | tan δ | 150% or less of Initial Specified Value | | | | | | |
| | Leakage Current | Initial Specified Value or less | | | | | | |
| Standard | JIS C 5101-4- 1 (IEC 60384) | | | | | | | |

Frequency Coefficient of Permissible Ripple Current

| Rated Voltage (V) | Frequency (HZ) | | | |
|-------------------|----------------|------|------|------|
| | 50 | 120 | 1K | ≥10K |
| 10 ~ 100 | 0.88 | 1.00 | 1.15 | 1.15 |
| 160 ~ 250 | 0.85 | 1.00 | 1.15 | 1.20 |
| 330 ~ 550 | 0.88 | 1.00 | 1.10 | 1.15 |

The endurance of capacitors is reduced with internal heating produced by ripple current at the rate of halving the lifetime with every 10°C rise. When long life performance is required in actual use, the rms ripple current has to be reduced.

SIJ Series

Dimensions (mm)

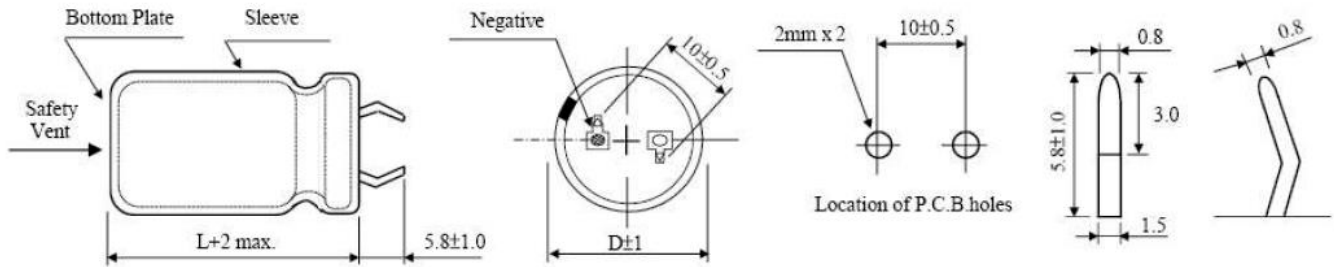

Standard Ratings

DxL (mm); R.C. (A rms) at 85°C 120Hz

| Cap (μF) | V Item | 10 | | 16 | | 25 | | 35 | | 50 | | 63 | | 80 | |
|--------------------------|----------------|-------|----------------|-------|----------------|----------------|----------------|----------------|----------------|----------------|-------|----------------|-------|----------------|------|
| | | D x l | R.C. | D x l | R.C. | D x l | R.C. | D x l | R.C. | D x l | R.C. | D x l | R.C. | D x l | R.C. |
| 820 | | | | | | | | | | | | | | 22x25 | 1.37 |
| 1000 | | | | | | | | | | | | 22x25 | 1.55 | 22x25 | 1.67 |
| 1500 | | | | | | | | | | | | 22x25 | 1.71 | 22x30 25x25 | 1.84 |
| 2200 | | | | | | | | | | 22x25 | 2.12 | 22x30 25x25 | 2.63 | 22x35 25x30 | 2.70 |
| 2700 | | | | | | | | | | 22x30 | 2.37 | 22x35 25x30 | 2.86 | 22x40 25x30 | 2.88 |
| 3300 | | | | | | | | | | 22x30 25x25 | 2.70 | 22x40 25x30 | 2.94 | 22x45 25x40 | 3.37 |
| 3900 | | | | | | | | 22x25 | 2.49 | 22x35 25x30 | 2.77 | 22x45 25x35 | 3.21 | 25x45 30x35 | 3.47 |
| 4700 | | | | | | 22x25 | 2.54 | 22x30 25x25 | 2.69 | 22x40 25x35 | 3.15 | 22x50 25x40 | 3.46 | 25x50 30x40 | 3.69 |
| 6800 | | | | 22x25 | 2.45 | 22x30 25x25 | 2.62 | 22x40 25x30 | 2.87 | 22x50 25x40 | 3.94 | 25x50 30x40 | 4.43 | 30x50 35x40 | 4.77 |
| 8200 | | | | 22x25 | 2.96 | 22x35 25x25 | 3.02 | 22x45 25x35 | 3.18 | 25x50 30x40 | 4.51 | 30x45 35x35 | 4.94 | 35x45 | 5.06 |
| 10000 | 22x25 | 2.12 | 22x30 | 3.14 | 22x40 25x30 | 3.47 | 22x50 25x40 | 3.62 | 25x50 30x40 | 5.08 | 35x40 | 5.62 | 35x50 | 6.20 | |
| 12000 | 22x25 | 2.45 | 22x30 25x25 | 3.57 | 22x45 25x35 | 3.68 | 25x45 30x35 | 4.1 | 30x50 35x35 | 5.26 | 35x50 | 6.34 | | | |
| 15000 | 22x30 | 2.82 | 22x35 25x30 | 4.03 | 25x45 30x35 | 4.18 | 30x40 35x35 | 5.11 | 35x45 | 6.58 | | | | | |
| 18000 | 22x35 25x25 | 3.20 | 22x40 25x35 | 4.49 | 25x45 30x35 | 4.56 | 30x45 35x40 | 5.66 | 35x50 | 6.85 | | | | | |
| 22000 | 22x40 25x30 | 3.60 | 22x50 25x40 | 4.80 | 25x50 30x45 | 5.32 | 35x45 | 6.14 | | | | | | | |
| 27000 | 22x45 25x35 | 4.26 | 25x45 30x35 | 5.62 | 30x50 35x40 | 6.14 | 35x50 | 6.99 | | | | | | | |
| 33000 | 22x50 25x40 | 5.31 | 25x50 30x40 | 5.94 | 35x45 | 6.92 | 35x45 | 7.09 | | | | | | | |
| 39000 | 25x45 30x35 | 5.41 | 30x45 35x35 | 6.49 | 35x45 | 7.75 | 35x50 | 7.30 | | | | | | | |
| 47000 | 30x40 | 6.10 | 30x50 35x40 | 7.13 | 35x50 | 8.04 | | | | | | | | | |
| 56000 | 30x45 | 6.73 | 35x45 | 7.31 | | | | | | | | | | | |
| 68000 | 35x40 | 7.43 | 35x50 | 10.30 | | | | | | | | | | | |

Standard Ratings

| Cap (µF) | V | 100 | | 160 | | 200 | | 250 | | 350 | | 400 | | 450 | | 500 | |
|-------------|----------------|------|-------|----------------|------|----------------|------|----------------|-------|----------------|------|----------------|-------|----------------|------|----------------|--------------|
| | | Item | D x L | R.C. | DxL | R.C. | DxL | R.C. | D x L | R.C. | DxL | R.C. | D x L | R.C. | DxL | R.C. | D x L |
| 47 | | | | | | | | | | | | 22x25 | 0.43 | 22x25 | 0.47 | 22x35 | 0.48 |
| 100 | | | | | | | | | | 22x25 | 0.79 | 22x30 25x25 | 1.07 | 22x35 25x25 | 1.12 | 25x40 | 1.15 |
| 120 | | | | | | | | | | 22x30 25x25 | 0.95 | 22x35 25x25 | 1.17 | 22x40 25x30 | 1.23 | 25x45 | 1.28 |
| 150 | | | | | | | | 22x25 | 1.12 | 22x35 25x30 | 1.18 | 22x40 25x30 | 1.28 | 22x45 25x35 | 1.47 | 25x50 30x35 | 1.53 1.51 |
| 220 | | | | 22x20 | 1.14 | 22x25 25x20 | 1.40 | 22x30 25x25 | 1.47 | 22x45 25x35 | 1.50 | 22x50 25x40 | 1.80 | 25x45 30x40 | 1.81 | 30x45 | 1.82 |
| 330 | | | | 22x25 25x20 | 1.48 | 22x30 25x25 | 1.92 | 22x35 25x30 | 1.97 | 25x50 30x40 | 2.03 | 30x40 35x30 | 2.35 | 30x45 35x40 | 2.85 | 35x45 | 2.87 |
| 470 | | | | 22x30 25x25 | 1.87 | 22x40 25x30 | 2.30 | 22x45 25x35 | 2.44 | 30x50 35x40 | 2.49 | 35x45 | 2.88 | 35x50 | 2.98 | 35x60 | 3.06 |
| 560 | | | | 22x35 25x30 | 2.07 | 22x40 25x30 | 2.62 | 25x40 30x35 | 2.87 | 35x45 | 3.36 | 35x50 | 3.43 | 35x55 | 3.21 | 35x60 | 3.09 |
| 680 | 22x25 | 1.57 | | 22x35 25x30 | 2.42 | 22x50 25x40 | 2.90 | 25x50 30x40 | 3.28 | 35x50 | 3.51 | 35x50 | 3.57 | 35x60 | 3.43 | 35x70 | 3.34 |
| 820 | 22x25 25x20 | 1.92 | | 22x40 25x35 | 2.81 | 25x45 30x35 | 3.42 | 30x45 35x40 | 3.58 | 35x50 | 3.65 | 35x60 | 3.91 | 35x65 | 3.66 | 40x70 | 3.84 |
| 1000 | 22x30 25x25 | 1.98 | | 25x40 30x35 | 3.28 | 25x50 30x40 | 3.87 | 30x50 35x45 | 4.02 | 35x55 | 3.97 | 35x65 | 4.28 | 35x70 | 3.89 | 45x80 | 4.29 |
| 1200 | 22x30 25x25 | 2.15 | | 25x40 30x35 | 3.48 | 25x50 30x40 | 4.16 | 30x50 35x45 | 4.54 | 35x60 | 4.25 | 35x70 | 4.50 | 40x70 | 4.09 | 45x90 | 4.59 |
| 1500 | 22x35 25x30 | 2.52 | | 30x45 35x35 | 4.04 | 30x50 35x40 | 5.12 | 35x50 | 5.47 | 35x65 | 4.65 | 40x70 | 4.61 | 45x70 | 4.21 | 45x100 | 4.90 |
| 2200 | 22x45 25x40 | 3.21 | | 35x45 | 4.77 | 35x50 | 6.21 | 40x60 | 6.25 | 45x75 | 5.87 | 45x85 | 5.75 | 145x100 | 5.32 | | |
| 2700 | 25x45 30x35 | 3.79 | | 35x50 | 5.46 | | | | | | | | | | | | |
| 3300 | 25x50 30x40 | 4.14 | | | | | | | | | | | | | | | |
| 3900 | 30x45 35x35 | 4.64 | | | | | | | | | | | | | | | |
| 4700 | 30x50 35x40 | 5.22 | | | | | | | | | | | | | | | |
| 6800 | 35x50 | 5.97 | | | | | | | | | | | | | | | |

SIK Series

- Snap-in type, 105°C10000 hours specially designed for audio equipment
- Select structural materials with high sound quality
- Create high definition audio equipment with high sound quality
- Suitable for high quality audio equipment
- RoHS Compliance.

Specifications

| Items | Characteristics | | | | | | |
|---|---|---|---------|-------------|-----------|-----------|------|
| Capacitance Tolerance | ± 20%(M) | | | | | | |
| Operating Temperature Range | -40~ +85°C | | | -25~ +85°C | | | |
| Rated Voltage Range | 16~ 250VDC | | | 400~ 450VDC | | | |
| Leakage Current | $I \leq 3VCV$ (μA) or 5Ma, Which is smaller (After 5 minutes application of DC rated voltage, at 20°C) | | | | | | |
| Dissipation Factor | Measurement Frequency: 120Hz. Temperature: 20°C | | | | | | |
| | Rated Voltage(V) | 16 | 25 ~ 75 | 80 ~ 100 | 180 | 200 ~ 400 | 450 |
| | tan δ | 0.35 | 0.30 | 0.25 | 0.15 | 0.15 | 0.20 |
| When the nominal capacitance over 22000μF, tan δ shall be added 0.01 to the listed value with increase of every 1000μF. | | | | | | | |
| Low Temperature Stability | Measurement Frequency: 120Hz. | | | | | | |
| | Rated Voltage(V) | 16 ~ 250 | | | 400 ~ 450 | | |
| | Z(-25°C) / Z(20°C) | 4 | | | 8 | | |
| Z(-40°C) / Z(20°C) | 12 | | | - | | | |
| Load Life | 2000 hours, with application of rated voltage at 105°C | | | | | | |
| | Capacitance Change | Within ± 20% of Initial Value (Within ±25% for 4V) | | | | | |
| | tan δ | 200% or less of Initial Specified Value | | | | | |
| | Leakage Current | Initial Specified Value or less | | | | | |
| Shelf Life | The following specifications shall be satisfied when the capacitors are restored to 20°C after exposing them for 1,000 hours 105°C without voltage applied. Before the measurement, the capacitor shall be preconditioned by applying voltage according to them | | | | | | |
| | Capacitance Change | Within ± 20% of Initial Value | | | | | |
| | tan δ | 200% or less of Initial Specified Value | | | | | |
| | Leakage Current | Initial Specified Value or less | | | | | |
| Standard | JIS C 5101-4- 1 (IEC 60384) | | | | | | |

Frequency Coefficient of Permissible Ripple Current

| Rated Voltage (V) | Frequency (Hz) | | | | | |
|-------------------|----------------|------|------|------|------|------|
| | 50 | 120 | 300 | 1K | 10K | 50K |
| 16 ~ 250 | 0.81 | 1.00 | 1.17 | 1.32 | 1.45 | 1.50 |
| 400 ~ 450 | 0.77 | 1.00 | 1.16 | 1.30 | 1.41 | 1.43 |

The endurance of capacitors is reduced with internal heating produced by ripple current at the rate of halving the lifetime with every 5°C rise. When long life performance is required in actual use, the rms ripple current has to be reduced.

SIK Series

Dimensions (mm)

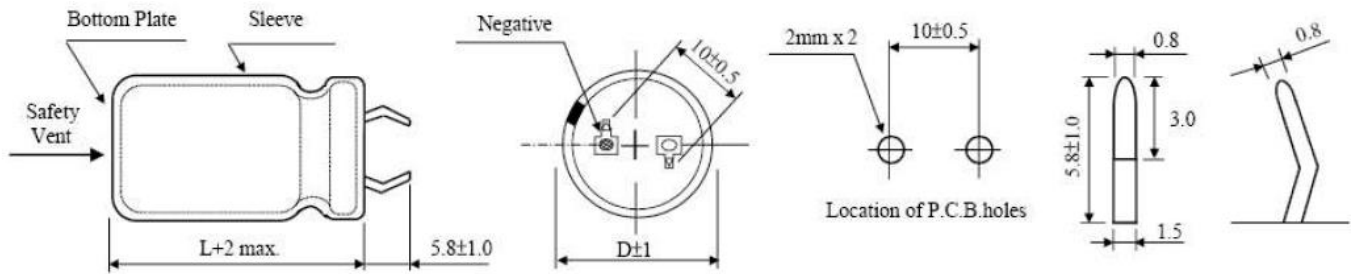

Standard Ratings

| Cap (µF) | V Item | 16 | | 25 | | 35 | | 50 | |
|-------------|-----------|-------|------|-------|------|-------|-------|-------|------|
| | | D x l | R.C. | D x l | R.C. | D x l | R.C. | D x l | R.C. |
| 1500 | | | | | | | | 22x20 | 1.34 |
| 1800 | | | | | | | | 20x25 | 1.47 |
| 2200 | | | | | | 22x20 | 1.26 | 25x20 | 1.43 |
| 2700 | | | | | | 20x30 | 1.39 | 20x30 | 1.6 |
| | | | | | | 22x25 | 1.6 | 22x25 | 1.6 |
| | | | | | | 25x20 | 1.34 | 20x35 | 1.73 |
| 3300 | | | | 22x20 | 1.30 | 20x30 | 1.52 | 22x30 | 1.73 |
| | | | | 20x25 | 1.39 | 22x25 | 1.52 | 25x25 | 1.69 |
| | | | | 25x20 | 1.34 | 30x20 | 1.6 | 30x20 | 1.78 |
| 3900 | | | | 20x30 | 1.47 | 20x35 | 1.91 | 20x40 | 1.95 |
| | | | | 22x25 | 1.47 | 22x30 | 1.9 1 | 22x35 | 1.91 |
| | | | | 25x20 | 1.34 | 25x25 | 1.86 | 20x45 | 2.13 |
| 4700 | 22x20 | 1.17 | | 20x30 | 1.47 | 20x50 | 2.17 | 22x40 | 2.04 |
| | | | | 22x25 | 1.47 | 22x40 | 2.26 | 25x30 | 2.17 |
| | | | | 25x20 | 1.34 | 30x20 | 1.6 | 30x25 | 2.04 |
| 5600 | 20x25 | 1.26 | | 25x20 | 1.34 | 35x20 | 1.95 | 35x20 | 2.13 |
| | | | | 20x35 | 1.91 | 20x50 | 2.17 | 25x30 | 2.17 |
| | | | | 22x30 | 1.91 | 22x40 | 2.26 | 30x25 | 2.04 |
| 6800 | 25x20 | 1.47 | | 25x25 | 1.86 | 30x25 | 2.26 | 35x20 | 2.13 |
| | | | | 20x40 | 2.08 | 30x35 | 2.82 | 25x45 | 2.86 |
| | | | | 22x35 | 2.04 | 30x40 | 3.08 | 30x35 | 2.82 |
| 8200 | 20x30 | 1.65 | | 22x35 | 2.04 | 25x40 | 2.34 | 30x40 | 3.08 |
| | | | | 25x30 | 2.00 | 30x30 | 2.39 | 30x40 | 3.08 |
| | 22x25 | 1.65 | | 35x20 | 1.95 | 30x30 | 2.39 | 35x30 | 3.17 |
| 10000 | 20x35 | 1.78 | | 20x50 | 2.21 | 25x45 | 2.65 | 35x30 | 3.17 |
| | 22x30 | 1.78 | | 22x40 | 2.3 | 30x35 | 2.60 | 30x45 | 3.47 |
| | 25x25 | 1.73 | | 25x35 | 2.17 | 35x25 | 2.78 | 30x45 | 3.47 |
| | 30x20 | 1.82 | | 30x25 | 2.3 | 35x25 | 2.78 | 35x35 | 3.47 |
| 12000 | 20x40 | 1.95 | | 22x45 | 2.52 | 25x50 | 3.00 | 35x35 | 3.47 |
| | 22x35 | 1.91 | | 25x40 | 2.39 | 30x40 | 2.86 | 35x40 | 3.78 |
| | 25x30 | 1.86 | | 30x30 | 2.43 | 35x30 | 2.95 | 35x40 | 3.78 |
| | 35x20 | 1.82 | | 35x25 | 2.3 | 35x30 | 2.95 | 35x40 | 3.78 |
| 15000 | 20x45 | 2.26 | | 25x45 | 2.73 | 30x45 | 3.30 | 35x40 | 3.78 |
| | 22x40 | 2.17 | | 25x45 | 2.73 | 30x45 | 3.30 | 35x50 | 4.08 |
| | 25x35 | 2.00 | | 30x35 | 2.69 | 35x35 | 3.30 | 35x50 | 4.08 |
| | 30x25 | 2.17 | | 30x35 | 2.69 | 35x35 | 3.30 | 35x50 | 4.08 |
| | 22x45 | 2.43 | | 25x50 | 3.08 | 30x50 | 3.73 | | |

| | | | | | | | | |
|--------------|-------|------|-------|------|-------|------|--|--|
| 18000 | 25x40 | 2.26 | 30x40 | 2.95 | 35x40 | 3.60 | | |
| | 30x30 | 2.30 | 35x30 | 3.04 | | | | |
| 22000 | 25x45 | 2.56 | 30x45 | 3.34 | 35x45 | 4.08 | | |
| | 30x35 | 2.52 | 35x35 | 3.34 | | | | |
| 27000 | 25x50 | 2.95 | 35x40 | 3.73 | | | | |
| | 30x40 | 2.82 | | | | | | |
| 33000 | 35x30 | 2.91 | 35x45 | 4.21 | | | | |
| | 30x45 | 3.21 | | | | | | |
| | 35x35 | 3.17 | | | | | | |

Standard Ratings

| Cap | V | 63 | | 80 | | 100 | |
|--------------|------|-------|------|-------|------|-------|------|
| (µF) | Item | D x l | R.C. | D x l | R.C. | D x l | R.C. |
| 680 | | | | | | 20x30 | 1.47 |
| | | | | | | 22x25 | 1.52 |
| 820 | | 22x20 | 1.13 | 20x25 | 1.47 | 20x35 | 1.60 |
| | | | | 25x20 | 1.43 | 22x30 | 1.60 |
| 1000 | | 20x25 | 1.26 | 20x30 | 1.56 | 25x25 | 1.56 |
| | | | | 22x25 | 1.60 | 30x20 | 1.65 |
| 1200 | | 25x20 | 1.43 | 20x35 | 1.69 | 20x40 | 1.78 |
| | | | | 22x30 | 1.69 | 25x30 | 2.00 |
| 1500 | | 20x30 | 1.65 | 25x25 | 1.65 | 25x30 | 2.04 |
| | | | | 22x25 | 1.65 | 30x25 | 1.91 |
| 1800 | | 20x35 | 1.78 | 20x40 | 1.91 | 30x20 | 2.00 |
| | | | | 22x30 | 1.73 | 22x45 | 2.21 |
| 2200 | | 25x25 | 1.73 | 25x30 | 1.82 | 25x45 | 2.78 |
| | | | | 30x20 | 1.78 | 30x35 | 2.78 |
| 2700 | | 20x40 | 1.95 | 35x20 | 2.17 | 35x30 | 2.6 |
| | | | | 22x35 | 1.91 | 30x30 | 2.43 |
| 3300 | | 25x30 | 1.86 | 20x50 | 2.08 | 30x40 | 3.08 |
| | | | | 35x20 | 1.82 | 22x40 | 2.15 |
| 3900 | | 20x50 | 2.08 | 25x35 | 2.04 | 35x35 | 2.82 |
| | | | | 30x25 | 2.17 | 25x50 | 2.82 |
| 4700 | | 22x45 | 2.43 | 30x25 | 2.17 | 30x50 | 3.26 |
| | | | | 25x40 | 2.26 | 35x25 | 2.60 |
| 5600 | | 30x30 | 2.34 | 25x45 | 2.47 | 30x40 | 3.26 |
| | | | | 30x35 | 2.47 | 35x30 | 2.78 |
| 6800 | | 25x45 | 2.47 | 30x45 | 3.00 | 35x40 | 3.73 |
| | | | | 35x25 | 2.60 | 35x35 | 2.95 |
| 8200 | | 30x45 | 2.78 | 30x45 | 3.34 | 35x40 | 3.91 |
| | | | | 30x40 | 2.69 | 35x45 | 3.56 |
| 10000 | | 35x30 | 2.78 | 35x40 | 3.26 | | |
| | | | | 30x45 | 3.00 | 35x50 | 4.04 |
| | | 35x35 | 2.95 | | | | |
| | | 30x50 | 3.39 | | | | |
| | | 35x40 | 3.26 | | | | |
| | | 35x45 | 3.65 | | | | |
| | | 35x50 | 4.17 | | | | |

SIG Series

- Snap-in type, 105°C/10000 hours long life product.
- Long life, and high ripple current resistance.
- Suitable for computer equipment, inverter air conditioner etc.
- RoHS Compliance.

Specifications

| Items | Characteristics | | | | | |
|-----------------------------|---|---|---------|------|------|------|
| Capacitance Tolerance | ± 20%(M) | | | | | |
| Operating Temperature Range | -25 ~ +105°C | | | | | |
| Rated Voltage Range | 200 ~ 450VDC | | | | | |
| Leakage Current | $I \leq 3VCV$ (μA) or 5mA, which is greater. (After 5 minutes application of DC rated voltage, at 20 °C) | | | | | |
| Dissipation Factor (tan δ) | Measurement Frequency: 120Hz. Temperature: 20°C | | | | | |
| | Rated Voltage(V) | 160 | 200~400 | 420 | 450 | 500 |
| | tan δ (Max) | 0.15 | 0.15 | 0.15 | 0.20 | 0.20 |
| Temperature Stability | Measurement Frequency: 120Hz. | | | | | |
| | Rated Voltage(V) | 200~400V | | | 450V | |
| | Z(-25°C) / Z(20°C) | 4 | | | 8 | |
| Load Life | 10000hours, with application of rated voltage at 105°C | | | | | |
| | Capacitance Change | Within ± 20% of the Initial Value | | | | |
| | tan δ | 250% or less of Initial Specified Value | | | | |
| | Leakage Current | Initial Specified Value or less | | | | |
| Shelf Life | The following specifications shall be satisfied when the capacitors are restored to 20°C after exposing them for 1,000 hours 105°C without voltage applied. Before the measurement, the capacitor shall be preconditioned by applying voltage according to them 4.1 of JIS C5101-4. | | | | | |
| | Capacitance Change | Within ± 15% of the Initial Value | | | | |
| | tan δ | 150% or less of initial Specified Value | | | | |
| | Leakage Current | Initial Specified Value or less | | | | |
| Standards | JIS C 5101-4-1 (IEC 60384) | | | | | |

Frequency Coefficient of Permissible Ripple Current

| Rated Voltage (V) | Frequency (Hz) | | | | | |
|-------------------|----------------|------|------|------|------|------|
| | 50 | 120 | 300 | 1K | 10K | 50K |
| 200~250 | 0.81 | 1.00 | 1.17 | 1.32 | 1.45 | 1.50 |
| 400~450 | 0.77 | 1.00 | 1.16 | 1.30 | 1.41 | 1.43 |

The endurance of capacitors is reduced with internal heating produced by ripple current at the rate of halving the lifetime with every 5°C rise. When long life performance is required in actual use, the rms ripple current has to be reduced.

SIG Series

Dimensions (mm)

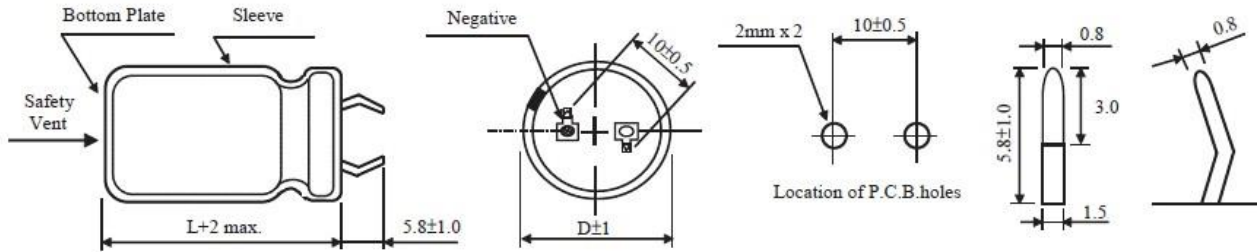

Standard Ratings

DxL (mm); R.C. (A rms) at 105°C 120Hz

| Cap (µF) | V (Code) | 200 | | 250 | | 400 | | 450 | |
|----------|----------|-------|------|-------|-------|-------|------|-------|------|
| | Item | D x L | R.C. | D x L | R.C. | D x L | R.C. | D x L | R.C. |
| 220 | | | | | | 30x35 | 1.01 | 30x40 | 1.05 |
| | | | | | 35x30 | | | 1.03 | |
| 270 | | | | | | 30x40 | 1.20 | 30x45 | 1.20 |
| | | | | | | 35x30 | 1.15 | 35x35 | 1.15 |
| 330 | | | | | | 30x45 | 1.30 | 30x50 | 1.32 |
| | | | | | | 35x35 | 1.28 | | |
| | | | | | | 40x30 | 1.28 | 35x40 | 1.35 |
| 390 | | | | 30x30 | 1.31 | 30x50 | 1.45 | 35x45 | 1.50 |
| | | | | | | 35x40 | 1.45 | | |
| 470 | | | | 30x35 | 1.42 | 35x45 | 1.61 | 35x50 | 1.65 |
| | | | | | | 40x35 | 1.60 | | |
| | | | | | | 35x50 | 1.80 | | |
| 560 | | 30x30 | 1.51 | 35x30 | 1.60 | 40x40 | 1.80 | 40x60 | 2.00 |
| | | | | | | | | | |
| 680 | | 30x35 | 1.65 | 30x45 | 1.78 | 40x50 | 2.05 | | |
| | | | | 35x35 | 1.78 | | | | |
| 820 | | 30x40 | 2.02 | 30x50 | 2.05 | 40x60 | 2.35 | | |
| | | 35x30 | | 35x40 | 2.02 | | | | |
| | | | | 40x30 | 1.98 | | | | |
| 1000 | | 30x45 | 2.21 | 35x45 | 2.20 | | | | |
| | | 35x35 | | 40x35 | 2.30 | | | | |
| | | 40x30 | | 2.15 | | | | | |
| 1200 | | 35x40 | 2.38 | 35x50 | 2.58 | | | | |
| | | 40x35 | 2.45 | 40x40 | 2.55 | | | | |
| 1500 | | 35x50 | 2.85 | 40x50 | 2.98 | | | | |
| | | 40x40 | 2.80 | | | | | | |
| 1800 | | 40x50 | 3.25 | 40x60 | 3.40 | | | | |

SMA Series

- Standard type of V-chip, -55 ~ +85°C
- Applicable to SMT process
- RoHS Compliant.

Specifications

| Items | Characteristics | | | | | | | | |
|------------------------------|--|--|------|------|--------------------|------|---------------------------------|------|--------|
| Capacitance Tolerance | ± 20% (120Hz, 20°C) | | | | | | | | |
| Operating Temperature Range | -55 ~ +85°C | | | | | | | | |
| Rated Voltage Range | 4 ~ 100VDC | | | | | | | | |
| Capacitance Range | 0.1 ~ 1500μF | | | | | | | | |
| Leakage Current | $I \leq 0.01CV$ or $3(\mu A)$, which is greater. (After 2 minutes application of DC rated voltage, at 20°C) | | | | | | | | |
| Dissipation Factor | Measurement Frequency: 120Hz. Temperature: 20°C | | | | | | | | |
| | Rated Voltage(V) | 4 | 6.3 | 10 | 16 | 25 | 35 | 50 | 63~100 |
| | tan δ(Max) | 0.42 | 0.30 | 0.26 | 0.22 | 0.16 | 0.14 | 0.14 | 0.12 |
| Low Temperature Stability | Measurement Frequency: 120Hz. | | | | | | | | |
| | Rated Voltage(V) | 4 | 6.3 | 10 | 16 | 25 | 35 | 50 | 63~100 |
| Impedance Ratio (Max) | Z(-25°C) / Z(20°C) | 7 | 4 | 3 | 2 | 2 | 2 | 2 | 2 |
| | Z(-55°C) / Z(20°C) | 15 | 8 | 8 | 4 | 4 | 3 | 3 | 3 |
| Load Life | 2000 hours, with application of rated voltage at 85°C | | | | | | | | |
| | Capacitance Change | Within ± 20% of Initial Value (Within ±25% for 4V) | | | | | | | |
| | tan δ | 200% or less of Initial Specified Value | | | | | | | |
| | Leakage Current | Initial Specified Value or less | | | | | | | |
| Shelf Life | The following specifications shall be satisfied when the capacitors are restored to 20°C after exposing them for 1,000 hours 85°C without voltage applied. Before the measurement, the capacitor shall be preconditioned by applying voltage according to them 4.1 of JIS C5101-4. | | | | | | | | |
| | Capacitance Change | Within ± 20% of Initial Value | | | | | | | |
| | tan δ | 200% or less of Initial Specified Value | | | | | | | |
| | Leakage Current | Initial Specified Value or less | | | | | | | |
| Resistance to Soldering Heat | The capacitors shall be kept on the hot plate maintained at 250°C for 30 seconds. After removing from the hot plate and restored at room temperature they meet the characteristics requirements listed at right. | | | | Capacitance Change | | Within ±10% of Initial Value | | |
| | | | | | tan δ | | Initial Specified Value | | |
| | | | | | Leakage Current | | Initial Specified Value or less | | |
| Marking | Black print on the case top | | | | | | | | |

Frequency Coefficient for Ripple Current

| Frequency(Hz) | 50 | 120 | 300 | 1K | ≧ 10K |
|---------------|------|------|------|------|-------|
| Coefficient | 0.70 | 1.00 | 1.17 | 1.36 | 1.50 |

The endurance of capacitors is reduced with internal heating produced by ripple current at the rate of having the lifetime with every 10°C rise. When long life performance is required in actual use, the rms ripple current has to be reduced.

SMA Series

Dimensions (mm)

Chip Type

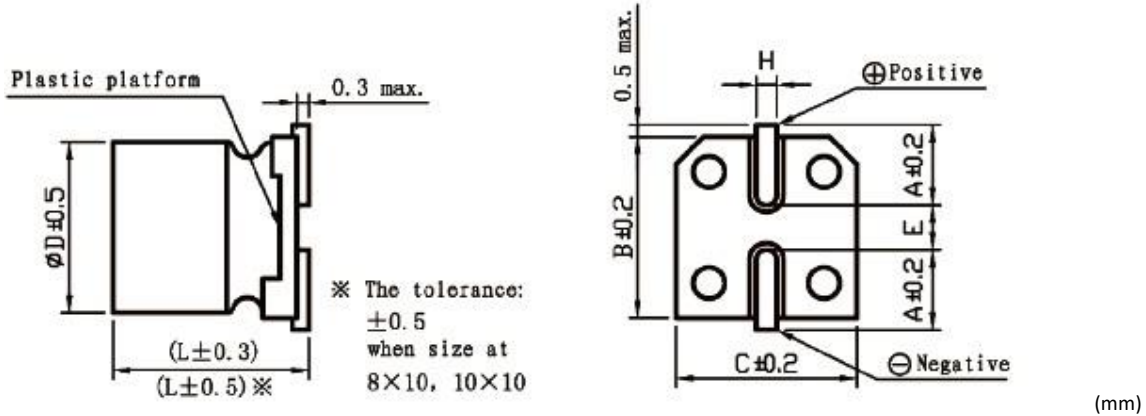

| $\phi D \times L$ | 4x5.4 | 5x5.4 | 6.3x5.4 | 6.3x7.7 | 8x10 | 10x10 |
|-------------------|-----------|-----------|-----------|-----------|-----------|-----------|
| A | 1.8 | 2.1 | 2.4 | 2.4 | 2.9 | 3.2 |
| B | 4.3 | 5.3 | 6.6 | 6.6 | 8.3 | 10.3 |
| C | 4.3 | 5.3 | 6.6 | 6.6 | 8.3 | 10.3 |
| E | 1.0 | 1.3 | 2.2 | 2.2 | 3.1 | 4.5 |
| L | 5.4 | 5.4 | 5.4 | 7.7 | 10.0 | 10.0 |
| H | 0.5 ~ 0.8 | 0.5 ~ 0.8 | 0.5 ~ 0.8 | 0.5 ~ 0.8 | 0.8 ~ 1.1 | 0.8 ~ 1.1 |

Standard Ratings

DxL(mm) ; R.C.(mA RMS) at 85°C 120Hz.

| Cap (μF) | V (Code) | 4 | | 6.3 | | 10 | | 16 | | 25 | |
|----------|----------|---------|------|---------|------|---------|------|---------|------|---------|------|
| | | DxL | R.C. | DxL | R.C. | DxL | R.C. | DxL | R.C. | DxL | R.C. |
| 4.7 | | | | | | | | | | 4x5.4 | 16 |
| 10 | | | | | | 4x5.4 | 28 | 4x5.4 | 23 | 4x5.4 | 23 |
| 22 | | 4x5.4 | 28 | 4x5.4 | 28 | 5x5.4 | 33 | 5x5.4 | 37 | 5x5.4 | 34 |
| 33 | | 4x5.4 | 28 | 4x5.4 | 28 | 5x5.4 | 41 | 5x5.4 | 49 | 6.3x5.4 | 47 |
| 47 | | 4x5.4 | 33 | 5x5.4 | 45 | 5x5.4 | 52 | 6.3x5.4 | 58 | 6.3x5.4 | 57 |
| 56 | | 5x5.4 | 42 | 6.3x5.4 | 52 | 6.3x5.4 | 57 | 6.3x5.4 | 63 | 6.3x5.4 | 62 |
| 100 | | 5x5.4 | 56 | 6.3x5.4 | 65 | 6.3x5.4 | 76 | 6.3x5.4 | 86 | 6.3x7.7 | 130 |
| 150 | | 6.3x5.4 | 79 | 6.3x5.4 | 71 | 6.3x7.7 | 130 | 6.3x7.7 | 130 | | |
| 220 | | 6.3x5.4 | 96 | 6.3x5.4 | 105 | 6.3x7.7 | 130 | 6.3x7.7 | 130 | 8x10 | 250 |
| | | 6.3x7.7 | 130 | 6.3x7.7 | 130 | | | 8x10 | 250 | | |
| 330 | | 6.3x7.7 | 130 | 6.3x7.7 | 130 | 8x10 | 250 | 8x10 | 250 | 10x10 | 310 |
| | | 6.3x7.7 | 130 | | | | | | | | |
| 470 | | 8x10 | 250 | 8x10 | 280 | 8x10 | 280 | 10x10 | 280 | | |
| 680 | | 8x10 | 300 | 8x10 | 300 | 10x10 | 350 | 10x10 | 350 | | |
| 1,000 | | 10x10 | 430 | 10x10 | 430 | 10x10 | 430 | | | | |
| 1,500 | | 10x10 | 480 | 10x10 | 480 | | | | | | |

SMA Series

Standard Ratings

DxL(mm) ; R.C.(mA RMS) at 85°C 120Hz.

| Cap (µF) | V | 35 | | 50 | | 63 | | 100 | |
|----------|------|---------|------|---------|------|---------|------|-------|------|
| | Item | DxL | R.C. | DxL | R.C. | DxL | R.C. | DxL | R.C. |
| 0.1 | | | | 4x5.4 | 3.0 | 4x5.4 | 2.0 | | |
| 0.22 | | | | 4x5.4 | 5.0 | 4x5.4 | 3.0 | | |
| 0.33 | | | | 4x5.4 | 6.0 | 4x5.4 | 4.0 | | |
| 0.47 | | | | 4x5.4 | 7.0 | 4x5.4 | 5.0 | | |
| 1 | | | | 4x5.4 | 10 | 4x5.4 | 8.0 | 4x5.4 | 6.0 |
| 2.2 | | 4x5.4 | 12 | 4x5.4 | 14 | 5x5.4 | 12 | 5x5.4 | 10 |
| 3.3 | | 4x5.4 | 16 | 4x5.4 | 19 | 5x5.4 | 17 | | |
| 4.7 | | 4x5.4 | 18 | 4x5.4 | 26 | 5x5.4 | 23 | | |
| 10 | | 5x5.4 | 29 | 5x5.4 | 31 | 6.3x5.4 | 42 | | |
| 22 | | 6.3x5.4 | 46 | 6.3x5.4 | 59 | 6.3x7.7 | 60 | 10x10 | 90 |
| 33 | | 6.3x5.4 | 51 | 6.3x7.7 | 75 | 8x10 | 110 | 10x10 | 90 |
| 47 | | 6.3x5.4 | 63 | 6.3x7.7 | 75 | 8x10 | 130 | | |
| 56 | | 6.3x7.7 | 70 | 8x10 | 175 | 10x10 | 160 | | |
| 100 | | 6.3x7.7 | 70 | 8x10 | 175 | 10x10 | 170 | | |
| | | 8x10 | 175 | | | | | | |
| 220 | | 10x10 | 320 | 10x10 | 320 | | | | |
| 330 | | 10x10 | 360 | | | | | | |

SMB Series

- Standard type of V-chip, -55 ~ +105°C
- Applicable to SMT process
- RoHS Compliant.

Specifications

| Items | Characteristics | | | | | | | | |
|------------------------------|---|---|------|------|------|------|--------------------|---------------------------------|--|
| Capacitance Tolerance | ± 20% (120Hz, 20°C) | | | | | | | | |
| Operating Temperature Range | -55 ~+105°C | | | | | | | | |
| Rated Voltage Range | 4 ~ 50VDC | | | | | | | | |
| Capacitance Range | 0.1 ~ 1500μF | | | | | | | | |
| Leakage Current | $I \leq 0.01CV$ or $3(\mu A)$, which is greater. (After 2 minutes application of DC rated voltage, at 20°C) | | | | | | | | |
| Dissipation Factor (tan δ) | Measurement Frequency: 120Hz. Temperature: 20°C | | | | | | | | |
| | Rated Voltage (V) | 4 | 6.3 | 10 | 16 | 25 | 35 | 50 | |
| | tan δ(Max) | 0.42 | 0.30 | 0.26 | 0.22 | 0.16 | 0.14 | 0.14 | |
| Low Temperature Stability | Measurement Frequency: 120Hz. | | | | | | | | |
| | Rated Voltage (V) | 4 | 6.3 | 10 | 16 | 25 | 35 | 50 | |
| Impedance Ratio (Max) | Z(-25°C)/Z(20°C) | 7 | 4 | 3 | 2 | 2 | 2 | 2 | |
| | Z(-55°C)/Z(20°C) | 15 | 8 | 8 | 4 | 4 | 3 | 3 | |
| Load Life | 1000 hours, with application of rated voltage at 105°C | | | | | | | | |
| | Capacitance Change | Within ± 25% of Initial Value | | | | | | | |
| | tan δ | 200% or less of Initial Specified Value | | | | | | | |
| | Leakage Current | Initial Specified Value or less | | | | | | | |
| Shelf Life | The following specifications shall be satisfied when the capacitors are restored to 20°C after exposing them for 1,000 hours 105°C without voltage applied. Before the measurement, the capacitor shall be preconditioned by applying voltage according to them 4.1 of JIS C5101-4. | | | | | | | | |
| | Capacitance Change | Within ± 20% of Initial Value | | | | | | | |
| | tan δ | 200% or less of Initial Specified Value | | | | | | | |
| | Leakage Current | Initial Specified Value or less | | | | | | | |
| Resistance to Soldering Heat | The capacitors shall be kept on the hot plate maintained at 250°C for 30 seconds. After removing from the hot plate and restored at room temperature they meet the characteristics requirements listed at right. | | | | | | Capacitance Change | Within ± 10% of Initial Value | |
| | | | | | | | tan δ | Initial Specified Value | |
| | | | | | | | Leakage Current | Initial Specified Value or less | |
| Marking | Black print on the case top | | | | | | | | |

Frequency Coefficient for Ripple Current

| Frequency(Hz) | 50 | 120 | 300 | 1K | ≥10K |
|---------------|------|------|------|------|------|
| Coefficient | 0.70 | 1.00 | 1.17 | 1.36 | 1.50 |

The endurance of capacitors is reduced with internal heating produced by ripple current at the rate of having the lifetime with every 5°C rise. When long life performance is required in actual use, the rms ripple current has to be reduced.

SMB Series

Dimensions (mm)

Chip Type

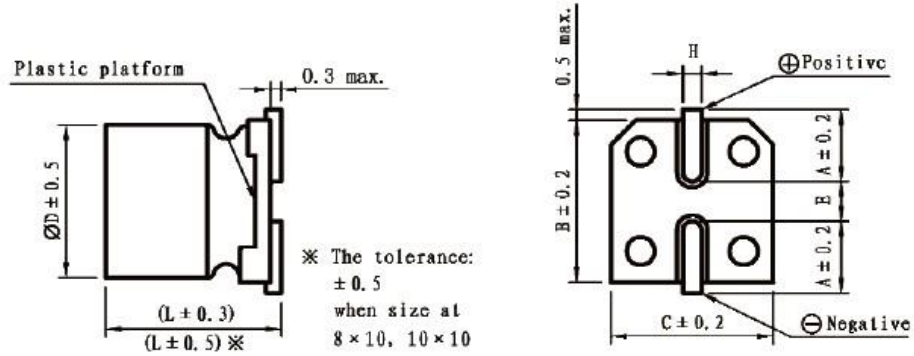

Unit (mm)

| Ø D x L | 4x5.4 | 5x5.4 | 6.3x5.4 | 6.3x7.7 | 8x10 | 10x10 |
|---------|---------|---------|---------|---------|---------|---------|
| A | 1.8 | 2.1 | 2.4 | 2.4 | 2.9 | 3.2 |
| B | 4.3 | 5.3 | 6.6 | 6.6 | 8.3 | 10.3 |
| C | 4.3 | 5.3 | 6.6 | 6.6 | 8.3 | 10.3 |
| E | 1.0 | 1.4 | 2.1 | 2.1 | 3.2 | 4.5 |
| L | 5.4 | 5.4 | 5.4 | 7.7 | 10 | 10 |
| H | 0.5~0.8 | 0.5~0.8 | 0.5~0.8 | 0.5~0.8 | 0.8~1.1 | 0.8~1.1 |

Standard Ratings

D x L (mm); R.C. (mA RMS) at 105°C 120Hz.

| Cap (µF) | V Item | 4 | | 6.3 | | 10 | | 16 | |
|----------|---------|----------|------|---------|------|---------|------|---------|------|
| | | D x L | R.C. | D x L | R.C. | D x L | R.C. | D x L | R.C. |
| 10 | | | | | | | | 4x5.4 | 18 |
| 22 | | 4x5.4 | 22 | 4x5.4 | 24 | 5x5.4 | 27 | 5x5.4 | 30 |
| 33 | | 5x5.4 | 30 | 5x5.4 | 33 | 5x5.4 | 35 | 6.3x5.4 | 40 |
| 47 | | 5x5.4 | 36 | 5x5.4 | 40 | 5x5.4 | 40 | 6.3x5.4 | 50 |
| 100 | | 6.3x5.4 | 60 | 6.3x5.4 | 66 | 6.3x5.4 | 79 | 6.3x5.4 | 90 |
| | 6.3x7.7 | | | | | 121 | | | |
| 150 | | 6.3x5.4 | 65 | 6.3x5.4 | 75 | 6.3x7.7 | 121 | 8x10 | 210 |
| 220 | | 6.3x5.4 | 79 | 6.3x5.4 | 79 | 6.3x7.7 | 121 | 8x10 | 210 |
| | 8x10 | | | | | 210 | | | |
| 330 | | 6x.3x7.7 | 121 | 6.3x7.7 | 121 | 8x10 | 210 | 8x10 | 210 |
| 470 | | 8x10 | 210 | 8x10 | 210 | 8x10 | 210 | 10x10 | 250 |
| 680 | | 8x10 | 210 | 8x10 | 210 | 10x10 | 310 | 10x10 | 310 |
| 1000 | | 8x10 | 230 | 10x10 | 350 | 10x10 | 410 | | |
| 1500 | | 10x10 | 410 | 10x10 | 410 | | | | |

SMB Series

Standard Ratings

DxL(mm) ; R.C.(mA RMS) at 105°C 120Hz.

| Cap (μ F) | V | 25 | | 35 | | 50 | |
|-------------------|------|---------|------|---------|------|---------|------|
| | Item | D x L | R.C. | D x L | R.C. | D x L | R.C. |
| 0.1 | | | | | | 4x5.4 | 1.0 |
| 0.22 | | | | | | 4x5.4 | 2.6 |
| 0.33 | | | | | | 4x5.4 | 3.2 |
| 0.47 | | | | | | 4x5.4 | 3.8 |
| 1 | | | | | | 4x5.4 | 6.3 |
| 2.2 | | | | | | 4x5.4 | 11 |
| 3.3 | | | | | | 4x5.4 | 14 |
| 4.7 | | 4x5.4 | 13 | 4x5.4 | 15 | 4x5.4 | 18 |
| 10 | | 4x5.4 | 22 | 5x5.4 | 25 | 6.3x5.4 | 30 |
| 22 | | 6.3x5.4 | 32 | 6.3x5.4 | 42 | 6.3x5.4 | 39 |
| 33 | | 6.3x5.4 | 48 | 6.3x5.4 | 47 | 6.3x7.7 | 60 |
| | | | | | | 8x10 | 70 |
| 47 | | 6.3x5.4 | 58 | 6.3x5.4 | 56 | 6.3x7.7 | 60 |
| | | | | | | 8x10 | 110 |
| 100 | | 6.3x7.7 | 84 | 6.3x7.7 | 84 | 8x10 | 140 |
| | | | | 8x10 | 131 | | |
| 150 | | 8x10 | 140 | 8x10 | 155 | 10x10 | 180 |
| 220 | | 8x10 | 155 | 8x10 | 190 | 10x10 | 220 |
| 330 | | 8x10 | 190 | 10x10 | 300 | | |
| 470 | | 10x10 | 300 | | | | |

SMC Series

- Non-polarity V-chip
- Applicable to SMT process
- RoHS Compliant.
- V-Chip
- Universal for SMT Process

Specifications

| Items | Characteristics | | | | | | |
|------------------------------|--|---|------|--------------------|---------------------------------|------|------|
| Capacitance Tolerance | ± 20% (120Hz, 20°C) | | | | | | |
| Operating Temperature Range | -55 ~ +85°C | | | | | | |
| Rated Voltage Range | 6.3 ~ 50VDC | | | | | | |
| Capacitance Range | 0.1 ~ 100μF | | | | | | |
| Leakage Current | $I \leq 0.03CV$ or 5 (μA) , which is greater. (After 2 minutes application of DC rated voltage, at 20°C) | | | | | | |
| Dissipation Factor | Measurement Frequency: 120Hz. Temperature: 20°C | | | | | | |
| | Rated Voltage(V) | 6.3 | 10 | 16 | 25 | 35 | 50 |
| | tan δ(Max) | 0.30 | 0.25 | 0.20 | 0.17 | 0.15 | 0.15 |
| Low Temperature Stability | Measurement Frequency: 120Hz. | | | | | | |
| | Rated Voltage(V) | 6.3 | 10 | 16 | 25 | 35 | 50 |
| Impedance Ratio (Max) | Z(-25°C)/Z(20°C) | 4 | 3 | 2 | 2 | 2 | 2 |
| | Z(-55°C)/Z(20°C) | 8 | 6 | 4 | 4 | 3 | 3 |
| Load Life | 1000 hours, with application of rated voltage at 85°C | | | | | | |
| | Capacitance Change | Within ± 20% of Initial Value | | | | | |
| | tan δ | 200% or less of Initial Specified Value | | | | | |
| | Leakage Current | Initial Specified Value or less | | | | | |
| Shelf Life | The following specifications shall be satisfied when the capacitors are restored to 20°C after exposing them for 1,000 hours 85°C without voltage applied. Before the measurement, the capacitor shall be preconditioned by applying voltage according to them 4.1 of JIS C5101-4. | | | | | | |
| | Capacitance Change | Within ± 20% of Initial Value | | | | | |
| | tan δ | 200% or less of Initial Specified Value | | | | | |
| | Leakage Current | Initial Specified Value or less | | | | | |
| Resistance to Soldering Heat | The capacitors shall be kept on the hot plate maintained at 250°C for 30 seconds. After removing from the hot plate and restored at room temperature they meet the characteristics requirements listed at right. | | | Capacitance Change | Within ±10% of Initial Value | | |
| | | | | tan δ | Initial Specified Value | | |
| | | | | Leakage Current | Initial Specified Value or less | | |
| Marking | Black print on the case top | | | | | | |

Frequency Coefficient for Ripple Current

| Frequency (Hz) | 50 | 120 | 300 | 1K | ≥ 10K |
|----------------|------|------|------|------|-------|
| Coefficient | 0.70 | 1.00 | 1.17 | 1.36 | 1.50 |

The endurance of capacitors is reduced with internal heating produced by ripple current at the rate of having the lifetime with every 10°C rise. When long life performance is required in actual use, the rms ripple current has to be reduced.

SMC Series

Dimensions (mm)

Chip Type

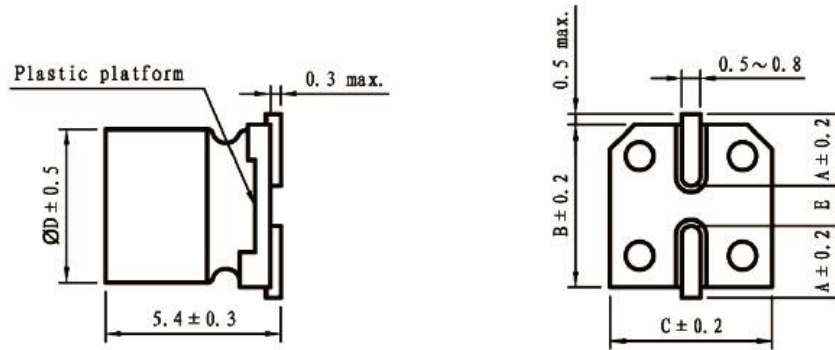

(mm)

| ØDxL | 4x5.4 | 5x5.4 | 6.3x5.4 |
|------|-------|-------|---------|
| A | 1.8 | 2.1 | 2.4 |
| B | 4.3 | 5.3 | 6.6 |
| C | 4.3 | 5.3 | 6.6 |
| E | 1.0 | 1.3 | 2.2 |

Standard Ratings

DxL(mm) ; R.C.(mA rms) at 85°C 120Hz.

| Cap (µF) | V | 6.3 | | 10 | | 16 | | 25 | | 35 | | 50 | |
|----------|---|---------|-----|---------|-----|---------|-----|---------|------|---------|-----|---------|-----|
| | | Item | DxL | R.C. | DxL | R.C. | DxL | DxL | R.C. | R.C. | DxL | R.C. | DxL |
| 0.1 | | | | | | | | | | | | 4x5.4 | 1.0 |
| 0.22 | | | | | | | | | | | | 4x5.4 | 2.0 |
| 0.33 | | | | | | | | | | | | 4x5.4 | 2.8 |
| 0.47 | | | | | | | | | | | | 4x5.4 | 4.0 |
| 1 | | | | | | | | | | | | 4x5.4 | 8.4 |
| 2.2 | | | | | | | | | | 4x5.4 | 8.4 | 5x5.4 | 13 |
| 3.3 | | | | | | | | 5x5.4 | 12 | 5x5.4 | 16 | 5x5.4 | 17 |
| 4.7 | | | | | | 4x5.4 | 12 | 5x5.4 | 16 | 5x5.4 | 18 | 6.3x5.4 | 20 |
| 10 | | | | 4x5.4 | 17 | 5x5.4 | 23 | 6.3x5.4 | 27 | 6.3x5.4 | 29 | 6.3x5.4 | 40 |
| 22 | | 4x5.4 | 28 | 4x5.4 | 33 | 5x5.4 | 37 | 6.3x5.4 | 50 | | | | |
| 33 | | 6.3x5.4 | 37 | 6.3x5.4 | 41 | 6.3x5.4 | 49 | | | | | | |
| 47 | | 6.3x5.4 | 45 | 6.3x5.4 | 54 | | | | | | | | |
| 100 | | 6.3x5.4 | 65 | | | | | | | | | | |

SMD Series

- Low impedance, 105°C V-chip
- Applicable to SMT process
- RoHS Compliant.
- V-Chip
- Universal for SMT Process

Specifications

| Items | Characteristics | | | | | | | | | |
|------------------------------|---|---|------|------|--------------------|------|---------------------------------|------|------|------|
| Capacitance Tolerance | ± 20% (120Hz, 20°C) | | | | | | | | | |
| Operating Temperature Range | -55 ~ +105°C | | | | | | | | | |
| Rated Voltage Range | 6.3 ~ 100VDC | | | | | | | | | |
| Capacitance Range | 1 ~ 1500μF | | | | | | | | | |
| Leakage Current | $I \leq 0.01CV$ or $3(\mu A)$, which is greater. (After 2 minutes application of DC rated voltage, at 20°C) | | | | | | | | | |
| Dissipation Factor | Measurement Frequency: 120Hz. Temperature: 20°C | | | | | | | | | |
| | Rated Voltage(V) | 6.3 | 10 | 16 | 25 | 35 | 50 | 63 | 80 | 100 |
| | tan δ(Max) | 0.30 | 0.26 | 0.22 | 0.16 | 0.13 | 0.10 | 0.08 | 0.08 | 0.07 |
| Low Temperature Stability | Measurement Frequency: 120Hz. | | | | | | | | | |
| | Rated Voltage(V) | 6.3 | 10 | 16 | 25 | 35 | 50 | 63 | 80 | 100 |
| Impedance Ratio (Max) | $Z(-25^\circ C) / Z(20^\circ C)$ | 4 | 3 | 2 | 2 | 2 | 2 | 2 | 2 | 2 |
| | $Z(-55^\circ C) / Z(20^\circ C)$ | 8 | 5 | 4 | 3 | 3 | 3 | 3 | 3 | 3 |
| Load Life | 3000 hours, with application of rated voltage at 105°C (∅D=4~6.3mm: 2000hrs) | | | | | | | | | |
| | Capacitance Change | Within ± 30% of Initial Value | | | | | | | | |
| | tan δ | 300% or less of Initial Specified Value | | | | | | | | |
| | Leakage Current | Initial Specified Value or less | | | | | | | | |
| Shelf Life | The following specifications shall be satisfied when the capacitors are restored to 20°C after exposing them for 1,000 hours 105°C without voltage applied. Before the measurement, the capacitor shall be preconditioned by applying voltage according to them 4.1 of JIS C5101-4. | | | | | | | | | |
| | Capacitance Change | Within ± 30% of Initial Value | | | | | | | | |
| | tan δ | 300% or less of Initial Specified Value | | | | | | | | |
| | Leakage Current | Initial Specified Value or less | | | | | | | | |
| Resistance to Soldering Heat | The capacitors shall be kept on the hot plate maintained at 250°C for 30 seconds. After removing from the hot plate and restored at room temperature they meet the characteristics requirements listed at right. | | | | Capacitance Change | | Within ±10% of Initial Value | | | |
| | | | | | tan δ | | Initial Specified Value | | | |
| | | | | | Leakage Current | | Initial Specified Value or less | | | |
| Marking | Black print on the case top | | | | | | | | | |

Frequency Coefficient for Ripple Current

| Frequency (Hz) | $120 \leq F < 1K$ | $1K \leq F < 10K$ | $10K \leq F < 100K$ | $100K \leq F$ |
|----------------|-------------------|-------------------|---------------------|---------------|
| ≤ 33 | 0.35 | 0.70 | 0.90 | 1.00 |
| 33 ~ 150 | 0.40 | 0.85 | 0.92 | 1.00 |
| > 150 | 0.60 | 0.85 | 0.95 | 1.00 |

The endurance of capacitors is reduced with internal heating produced by ripple current at the rate of having the lifetime with every 5°C rise. When long life performance is required in actual use, the rms ripple current has to be reduced.

SMD Series

Chip Type
Dimensions (mm)

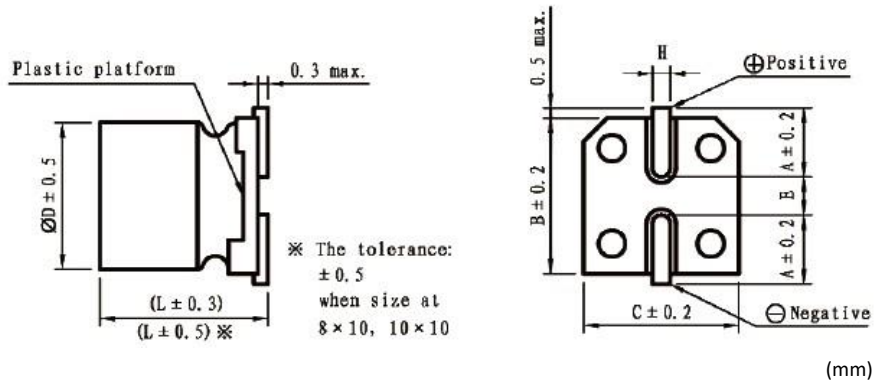

| ØDxL | 4x5.4 | 5x5.4 | 6.3x5.4 | 6.3x6.0 | 6.3x7.7 | 8x6.5 | 8x10 | 10x10 |
|------|-----------|-----------|-----------|-----------|-----------|-----------|-----------|-----------|
| A | 1.8 | 2.1 | 2.4 | 2.4 | 2.4 | 3.3 | 2.9 | 3.2 |
| B | 4.3 | 5.3 | 6.6 | 6.6 | 6.6 | 8.3 | 8.3 | 10.3 |
| C | 4.3 | 5.3 | 6.6 | 6.6 | 6.6 | 8.3 | 8.3 | 10.3 |
| E | 1.0 | 1.4 | 2.1 | 2.1 | 2.2 | 2.3 | 3.2 | 4.5 |
| L | 5.4 | 5.4 | 5.4 | 6.0 | 7.7 | 6.5 | 10 | 10 |
| H | 0.5 ~ 0.8 | 0.5 ~ 0.8 | 0.5 ~ 0.8 | 0.5 ~ 0.8 | 0.5 ~ 0.8 | 0.5 ~ 0.8 | 0.8 ~ 1.1 | 0.8 ~ 1.1 |

Standard Ratings

DxL(mm) ; R.C.(mA rms) at 105°C 100KHz, IMP (Ω max) at 20°C 100KHz.

| Cap (µF) | V | 6.3 | | | 10 | | | 16 | | | 25 | | | 35 | | |
|----------|---|---------|-----|------|---------|-----|------|---------|-----|------|---------|-----|------|---------|-----|------|
| | | Item | DxL | R.C. | IMP | DxL | R.C. | IMP | DxL | R.C. | IMP | DxL | R.C. | IMP | DxL | R.C. |
| 4.7 | | | | | | | | | | | | | | 4x5.4 | 80 | 2.0 |
| 10 | | | | | | | | 4x5.4 | 80 | 2.0 | 4x5.4 | 80 | 2.0 | 5x5.4 | 150 | 1.20 |
| 22 | | 4x5.4 | 80 | 2.0 | 4x5.4 | 80 | 2.0 | 5x5.4 | 150 | 1.20 | 5x5.4 | 150 | 1.20 | 6.3x5.4 | 230 | 0.80 |
| 33 | | 4x5.4 | 80 | 2.0 | 5x5.4 | 150 | 1.20 | 5x5.4 | 150 | 1.20 | 6.3x5.4 | 230 | 0.80 | 6.3x5.4 | 230 | 0.80 |
| 47 | | 5x5.4 | 150 | 1.20 | 5x5.4 | 150 | 1.20 | 5x5.4 | 150 | 1.20 | 6.3x5.4 | 230 | 0.80 | 6.3x5.4 | 230 | 0.80 |
| 100 | | 6.3x5.4 | 230 | 0.80 | 6.3x5.4 | 230 | 0.80 | 6.3x5.4 | 230 | 0.80 | 6.3x7.7 | 280 | 0.58 | 8x10 | 450 | 0.22 |
| 150 | | 6.3x5.4 | 230 | 0.80 | 6.3x5.4 | 230 | 0.80 | 6.3x7.7 | 280 | 0.58 | 8x10 | 450 | 0.22 | 8x10 | 450 | 0.22 |
| 220 | | 6.3x5.4 | 230 | 0.80 | 6.3x7.7 | 280 | 0.58 | 6.3x7.7 | 280 | 0.58 | 8x10 | 450 | 0.22 | 10x10 | 670 | 0.15 |
| 330 | | 8x10 | 450 | 0.22 | 8x10 | 450 | 0.22 | 8x10 | 450 | 0.22 | 8x10 | 450 | 0.22 | | | |
| 470 | | 8x10 | 450 | 0.22 | 8x10 | 450 | 0.22 | 8x10 | 450 | 0.22 | 10x10 | 670 | 0.15 | | | |
| 680 | | 8x10 | 450 | 0.22 | 10x10 | 670 | 0.15 | 10x10 | 670 | 0.15 | | | | | | |
| 1000 | | 8x10 | 450 | 0.22 | 10x10 | 670 | 0.15 | | | | | | | | | |
| 1500 | | 10x10 | 670 | 0.15 | | | | | | | | | | | | |

SMD Series

Standard Ratings

DxL(mm) ; R.C.(mA rms) at 105°C 100KHz, IMP (Ω max) at 20°C 100KHz.

| Cap (μF) | V | 50 | | | 63 | | | 80 | | | 100 | | |
|-------------|------|---------|------|------|---------|------|------|---------|-----|------|-------|------|------|
| | Item | DxL | R.C. | IMP | DxL | R.C. | IMP | DxL | R.C | IMP | DxL. | R.C. | IMP |
| 1 | | 4x5.4 | 60 | 9.0 | | | | | | | | | |
| 2.2 | | 4x5.4 | 60 | 9.0 | | | | | | | | | |
| 3.3 | | 4x5.4 | 60 | 9.0 | 5x5.4 | 85 | 5.0 | 5x5.4 | 50 | 5.3 | | | |
| 4.7 | | 5x5.4 | 85 | 5.0 | 5x5.4 | 85 | 5.0 | 6.3x5.4 | 60 | 4.8 | | | |
| 10 | | 6.3x5.4 | 165 | 2.2 | 6.3x5.4 | 165 | 2.2 | | | | 8x10 | 130 | 1.88 |
| 22 | | 6.3x5.4 | 165 | 2.2 | 6.3x7.7 | 185 | 1.4 | 8x10 | 130 | 1.88 | 10x10 | 200 | 0.90 |
| 33 | | 6.3x7.7 | 185 | 1.4 | 8x10 | 369 | 0.85 | 10x10 | 200 | 0.90 | 10x10 | 200 | 0.90 |
| 47 | | 6.3x7.7 | 185 | 1.4 | 8x10 | 369 | 0.85 | 10x10 | 200 | 0.90 | 10x10 | 200 | 0.90 |
| 68 | | 8x10 | 369 | 0.68 | 10x10 | 450 | 0.48 | 10x10 | 200 | 0.90 | | | |
| 100 | | 8x10 | 369 | 0.68 | 10x10 | 553 | 0.48 | | | | | | |
| | | 10x10 | 553 | 0.48 | | | | | | | | | |
| 150 | | 10x10 | 553 | 0.48 | | | | | | | | | |

SME Series

- Standard type of V-chip, 2000 hours, 105°C
- Applicable to SMT process
- RoHS Compliant.

Specifications

| Items | Characteristics | | | | | | |
|------------------------------|---|---|------|--------------------|---------------------------------|------|------|
| Capacitance Tolerance | ± 20% (120Hz, 20°C) | | | | | | |
| Operating Temperature Range | -55 ~ +105°C | | | | | | |
| Rated Voltage Range | 6.3 ~ 100VDC | | | | | | |
| Capacitance Range | 1 ~ 6800μF | | | | | | |
| Leakage Current | $I \leq 0.01CV$ or 3 (μA) , which is greater. (After 2 minutes application of DC rated voltage, at 20°C) | | | | | | |
| Dissipation Factor | Measurement Frequency: 120Hz. Temperature: 20°C | | | | | | |
| | Rated Voltage(V) | 6.3 | 10 | 16 | 25 | 35 | 50 |
| | tan δ(Max) | 0.32 | 0.28 | 0.24 | 0.18 | 0.15 | 0.14 |
| Low Temperature Stability | Measurement Frequency: 120Hz. | | | | | | |
| | Rated Voltage(V) | 6.3 | 10 | 16 | 25 | 35 | 50 |
| Impedance Ratio (Max) | Z(-25°C)/Z(20°C) | 4 | 3 | 2 | 2 | 2 | 2 |
| | Z(-55°C)/Z(20°C) | 8 | 8 | 4 | 4 | 3 | 3 |
| Load Life | 2000 hours, with application of rated voltage at 105°C | | | | | | |
| | Capacitance Change | Within ± 20% of Initial Value | | | | | |
| | tan δ | 200% or less of Initial Specified Value | | | | | |
| | Leakage Current | Initial Specified Value or less | | | | | |
| Shelf Life | The following specifications shall be satisfied when the capacitors are restored to 20°C after exposing them for 1,000 hours 105°C without voltage applied. Before the measurement, the capacitor shall be preconditioned by applying voltage according to them 4.1 of JIS C5101-4. | | | | | | |
| | Capacitance Change | Within ± 20% of Initial Value | | | | | |
| | tan δ | 200% or less of Initial Specified Value | | | | | |
| | Leakage Current | Initial Specified Value or less | | | | | |
| Resistance to Soldering Heat | The capacitors shall be kept on the hot plate maintained at 250°C for 30 seconds. After removing from the hot plate and restored at room temperature they meet the characteristics requirements listed at right. | | | Capacitance Change | Within ±10% of Initial Value | | |
| | | | | tan δ | Initial Specified Value | | |
| | | | | Leakage Current | Initial Specified Value or less | | |
| Marking | Black print on the case top | | | | | | |

Frequency Coefficient for Ripple Current

| Frequency(Hz) | 50 | 120 | 300 | 1K | ≥ 10K |
|---------------|------|------|------|------|-------|
| Coefficient | 0.70 | 1.00 | 1.17 | 1.36 | 1.50 |

The endurance of capacitors is reduced with internal heating produced by ripple current at the rate of having the lifetime with every 5°C rise. When long life performance is required in actual use, the rms ripple current has to be reduced.

SME Series

Chip Type
Dimensions (mm)

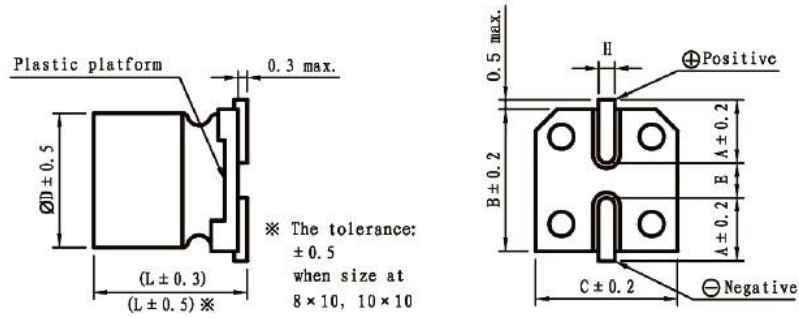

(mm)

| ØD×L | 4x5.4 | 5x5.4 | 6.3x5.4 | 6.3x7.7 | 8x10 | 10x10 |
|------|-----------|-----------|-----------|-----------|-----------|-----------|
| A | 1.8 | 2.1 | 2.4 | 2.4 | 2.9 | 3.2 |
| B | 4.3 | 5.3 | 6.6 | 6.6 | 8.3 | 10.3 |
| C | 4.3 | 5.3 | 6.6 | 6.6 | 8.3 | 10.3 |
| E | 1.0 | 1.3 | 2.2 | 2.2 | 3.1 | 4.5 |
| L | 5.4 | 5.4 | 5.4 | 7.7 | 10.0 | 10.0 |
| H | 0.5 ~ 0.8 | 0.5 ~ 0.8 | 0.5 ~ 0.8 | 0.5 ~ 0.8 | 0.8 ~ 1.1 | 0.8 ~ 1.1 |

Standard Ratings

D×L(mm) ; R.C.(mA rms) at 105°C 120Hz.

| Cap (µF) | V | 6.3 | | 10 | | 16 | | 25 | | 35 | | 50 | |
|----------|---|---------|-----|---------|-----|---------|-----|---------|------|---------|-----|---------|-----|
| | | Item | DxL | R.C. | DxL | R.C. | DxL | DxL | R.C. | R.C. | DxL | R.C. | DxL |
| 0.1 | | | | | | | | | | | | 4x5.4 | 1.0 |
| 0.22 | | | | | | | | | | | | 4x5.4 | 2.6 |
| 0.33 | | | | | | | | | | | | 4x5.4 | 3.2 |
| 0.47 | | | | | | | | | | | | 4x5.4 | 3.8 |
| 1 | | | | | | | | | | | | 4x5.4 | 8 |
| 2.2 | | | | | | | | 4x5.4 | 6.6 | 4x5.4 | 8 | 4x5.4 | 11 |
| 3.3 | | | | | | 4x5.4 | 7 | 4x5.4 | 12 | 4x5.4 | 13 | 4x5.4 | 16 |
| 4.7 | | | | 4x5.4 | 7 | 4x5.4 | 9 | 4x5.4 | 13 | 4x5.4 | 15 | 5x5.4 | 19 |
| 10 | | 4x5.4 | 10 | 4x5.4 | 13 | 4x5.4 | 28 | 5x5.4 | 28 | 5x5.4 | 28 | 6.3x5.4 | 35 |
| 22 | | 4x5.4 | 26 | 5x5.4 | 35 | 5x5.4 | 39 | 6.3x5.4 | 45 | 6.3x5.4 | 70 | 6.3x7.7 | 65 |
| 33 | | 4x5.4 | 29 | 6.3x5.4 | 43 | 6.3x5.4 | 51 | 6.3x5.4 | 65 | 6.3x5.4 | 70 | 8x10 | 140 |
| 47 | | 5x5.4 | 45 | 6.3x5.4 | 62 | 6.3x5.4 | 70 | 6.3x5.4 | 70 | 6.3x7.7 | 80 | 8x10 | 170 |
| | | | | | | | | 6.3x7.7 | 80 | | | | |
| 100 | | 6.3x5.4 | 71 | 6.3x5.4 | 90 | 6.3x7.7 | 100 | 6.3x7.7 | 100 | 8x10 | 305 | 8x10 | 315 |
| 220 | | 6.3x7.7 | 100 | 6.3x7.7 | 120 | 6.3x7.7 | 125 | 8x10 | 355 | 10x10 | 450 | 10x10 | 450 |
| | | | | | | 8x10 | 215 | | | | | | |
| 330 | | | | 8x10 | 215 | 10x10 | 440 | 10x10 | 450 | | | | |
| 470 | | 10x10 | 310 | 10x10 | 440 | 10x10 | 460 | 10x10 | 490 | | | | |
| 1000 | | 10x10 | 495 | | | | | | | | | | |

SMF Series

- Wide range of -55~+125°C, long life product.
- Applicable to SMT process.
- RoHS Compliant & Halogen Free

Specifications

| Items | Characteristics | | | | | | | | | |
|------------------------------|---|---|------|------|------|--------------------|------|---------------------------------|------|------|
| Capacitance Tolerance | ± 20% (120Hz, 20°C) | | | | | | | | | |
| Operating Temperature Range | -55 ~ +125°C | | | | | -40 ~ +125°C | | | | |
| Rated Voltage Range | 10 ~ 63VDC | | | | | 80 ~ 160VDC | | | | |
| Capacitance Range | 10 ~ 470μF | | | | | 2.2 ~ 4.7μF | | | | |
| Leakage Current | I ≤ 0.01CV or 3(μA) , which is greater. (After 2 minutes application of DC rated voltage, at 20°C) | | | | | | | | | |
| Dissipation Factor | Measurement Frequency: 120Hz. Temperature: 20°C | | | | | | | | | |
| | Rated Voltage(V) | 10 | 16 | 25 | 35 | 50 | 63 | 80 | 100 | 160 |
| | tan δ(Max) | 0.32 | 0.24 | 0.21 | 0.18 | 0.18 | 0.15 | 0.15 | 0.12 | 0.20 |
| Low Temperature Stability | Measurement Frequency: 120Hz. | | | | | | | | | |
| | Rated Voltage(V) | 10 | 16 | 25 | 35 | 50 | 63 | 80 | 100 | 160 |
| Impedance Ratio (Max) | Z(-25°C)/Z(20°C) | 3 | 2 | 2 | 2 | 2 | 2 | 2 | 2 | - |
| | Z(-40°C)/Z(20°C) | - | - | - | - | - | - | 3 | 3 | - |
| | Z(-55°C)/Z(20°C) | 6 | 4 | 4 | 3 | 3 | 3 | - | - | - |
| Load Life | 3000 hours, with application of rated voltage at 125°C (∅D=4~6.3x5.4mm: 1000hrs;6.3x7.7mm : 2000hrs) | | | | | | | | | |
| | Capacitance Change | Within ± 30% of Initial Value | | | | | | | | |
| | tan δ | 300% or less of Initial Specified Value | | | | | | | | |
| | Leakage Current | Initial Specified Value or less | | | | | | | | |
| Shelf Life | The following specifications shall be satisfied when the capacitors are restored to 20°C after exposing them for 1,000 hours 125°C without voltage applied. Before the measurement, the capacitor shall be preconditioned by applying voltage according to them 4.1 of JIS C5101-4. | | | | | | | | | |
| | Capacitance Change | Within ± 30% of Initial Value | | | | | | | | |
| | tan δ | 300% or less of Initial Specified Value | | | | | | | | |
| | Leakage Current | 500% or less Initial Specified Value | | | | | | | | |
| Resistance to Soldering Heat | The capacitors shall be kept on the hot plate maintained at 250°C for 30 seconds. After removing from the hot plate and restored at room temperature they meet the characteristics requirements listed at right. | | | | | Capacitance Change | | Within ±10% of Initial Value | | |
| | | | | | | tan δ | | Initial Specified Value | | |
| | | | | | | Leakage Current | | Initial Specified Value or less | | |
| Marking | Black print on the case top | | | | | | | | | |

Frequency Coefficient for Ripple Current

| Frequency (Hz) | 50 | 60 | 120 | 1K | ≥10K |
|----------------|------|------|------|------|------|
| Coefficient | 0.64 | 0.64 | 1.00 | 1.36 | 1.50 |

The endurance of capacitors is reduced with internal heating produced by ripple current at the rate of having the lifetime with every 5°C rise. When long life performance is required in actual use, the rms ripple current has to be reduced.

SMF Series

Chip Type
Dimensions (mm)

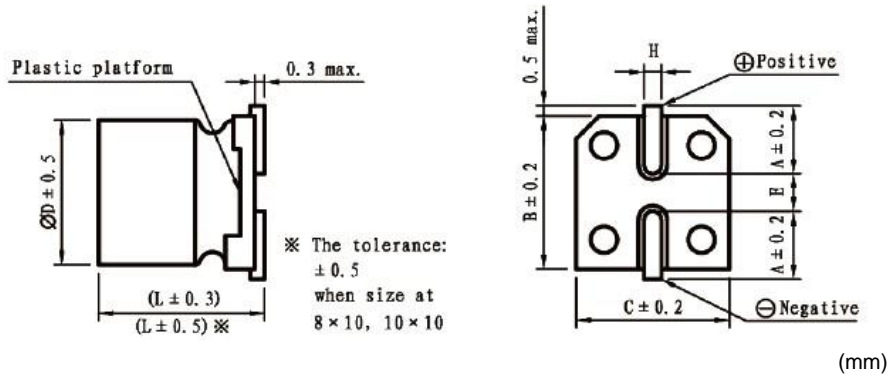

| ØD xL | 6.3x5.4 | 6.3x7.7 | 8x10 | 10x10 |
|-------|-----------|-----------|-----------|-----------|
| A | 2.4 | 2.4 | 2.9 | 3.2 |
| B | 6.6 | 6.6 | 8.3 | 10.3 |
| C | 6.6 | 6.6 | 8.3 | 10.3 |
| E | 2.1 | 2.1 | 3.2 | 4.5 |
| L | 5.4 | 7.7 | 10 | 10 |
| H | 0.5 ~ 0.8 | 0.5 ~ 0.8 | 0.8 ~ 1.1 | 0.8 ~ 1.1 |

Standard Ratings

DxL(mm) ; R.C.(mA rms) at 125°C 120Hz.

| Cap (µF) | V | 10 | | 16 | | 25 | | 35 | | 50 | |
|----------|------|---------|------|---------|------|---------|-----|---------|------|---------|------|
| | Item | DxL | R.C. | DxL | R.C. | DxL | DxL | R.C. | R.C. | DxL | R.C. |
| 10 | | | | | | | | 6.3x5.4 | 46 | 6.3x7.7 | 34 |
| 22 | | | | | | | | 6.3x5.4 | 46 | 6.3x7.7 | 55 |
| 33 | | | | | | 6.3x5.4 | 46 | 6.3x7.7 | 73 | 8x10 | 106 |
| 47 | | | | 6.3x5.4 | 40 | 6.3x7.7 | 73 | 6.3x7.7 | 73 | 8x10 | 106 |
| | | | | | | | | | | 10x10 | 164 |
| 100 | | 6.3x7.7 | 58 | 6.3x7.7 | 73 | 6.3x7.7 | 73 | 8x10 | 131 | 10x10 | 164 |
| | | | | | | 8x10 | 131 | 10x10 | 164 | | |
| 220 | | 6.3x7.7 | 58 | 8x10 | 131 | 8x10 | 131 | 10x10 | 164 | | |
| | | | | 10x10 | 164 | | | | | | |
| 330 | | 8x10 | 90 | 10x10 | 164 | 10x10 | 164 | | | | |
| | | 10x10 | 112 | | | | | | | | |
| 470 | | 10x10 | 130 | | | | | | | | |

SMF Series

Standard Ratings

DxL(mm) ; R.C.(mA rms) at 125°C 120Hz.

| Cap (µF) | V | 63 | | 80 | | 100 | | 160 | |
|----------|------|---------|------|-------|------|-------|-----|-------|------|
| | Item | DxL | R.C. | DxL | R.C. | DxL | DxL | R.C. | R.C. |
| 2.2 | | | | | | | | 8x10 | 22 |
| 3.3 | | | | | | | | 8x10 | 22 |
| 4.7 | | | | | | | | 10x10 | 70 |
| 10 | | 6.3x7.7 | 40 | 8x10 | 46 | 8x10 | 46 | | |
| 22 | | 8x10 | 66 | 8x10 | 46 | 8x10 | 46 | | |
| | | | | 10x10 | 76 | 10x10 | 76 | | |
| 33 | | 8x10 | 66 | 8x10 | 46 | 10x10 | 76 | | |
| | | 10x10 | 113 | 10x10 | 76 | | | | |
| 47 | | 8x10 | 66 | | | | | | |
| | | 10x10 | 113 | | | | | | |

SMG Series

- 105°C 2000 hours Life
- Suitable for lighting and power charger
- RoHS Compliant.

Specifications

| Items | Characteristics | | | | |
|------------------------------|---|---|--|--------------------|---------------------------------|
| Capacitance Tolerance | ± 20% (120Hz, 20°C) | | | | |
| Operating Temperature Range | -40 ~ +105°C | | | | |
| Rated Voltage Range | 160 ~ 400VDC | | | | |
| Capacitance Range | 2.2 ~ 82μF | | | | |
| Leakage Current | $I \leq 0.04CV + 100(\mu A)$, which is greater. (After 2 minutes application of DC rated voltage, at 20°C) | | | | |
| Dissipation Factor (tan δ) | Measurement Frequency: 120Hz. Temperature: 20°C | | | | |
| | Rated Voltage (V) | 1 | | | |
| | tan δ(Max) | 0 | | | |
| Low Temperature Stability | Measurement Frequency: 120Hz. | | | | |
| | Rated Voltage (V) | 200 | | | |
| Impedance Ratio (Max) | Z(-25°C)/Z(20°C) | | | | |
| | Z(-40°C)/Z(20°C) | | | | |
| Load Life | 2000 hours, with application of working voltage at 105°C | | | | |
| | Capacitance Change | Within ± 20% of Initial Value. | | | |
| | tan δ | 200% or less of Initial Specified Value | | | |
| | Leakage Current | Initial Specified Value or less | | | |
| Shelf Life | The following specifications shall be satisfied when the capacitors are restored to 20°C after exposing them for 500 hours 105°C without voltage applied. Before the measurement, the capacitor shall be preconditioned by applying voltage according to them 4.1 of JIS C5101-4. | | | | |
| | Capacitance Change | Within ± 20% of Initial Value | | | |
| | tan δ | 200% or less of Initial Specified Value | | | |
| | Leakage Current | Initial Specified Value or less | | | |
| Resistance to Soldering Heat | The capacitors shall be kept on the hot plate maintained at 250°C for 30 seconds. After removing from the hot plate and restored at room temperature they meet the characteristics requirements listed at right. | | | Capacitance Change | Within ± 10% of Initial Value |
| | | | | tan δ | Initial Specified Value |
| | | | | Leakage Current | Initial Specified Value or less |
| Marking | JIS C 5101-4-1 (IEC 60384) | | | | |

Frequency Coefficient for Ripple Current

| Frequency (Hz) | 50 | 120 | 300 | 1K | ≥10K |
|------------------|------|------|------|------|------|
| Capacitance (μF) | | | | | |
| 2.2 ~ 6.8 | 0.70 | 1.00 | 1.17 | 1.36 | 1.50 |

The endurance of capacitors is reduced with internal heating produced by ripple current at the rate of having the lifetime with every 5°C rise. When long life performance is required in actual use, the rms ripple current has to be reduced.

SMG Series

Dimensions (mm)

Chip Type

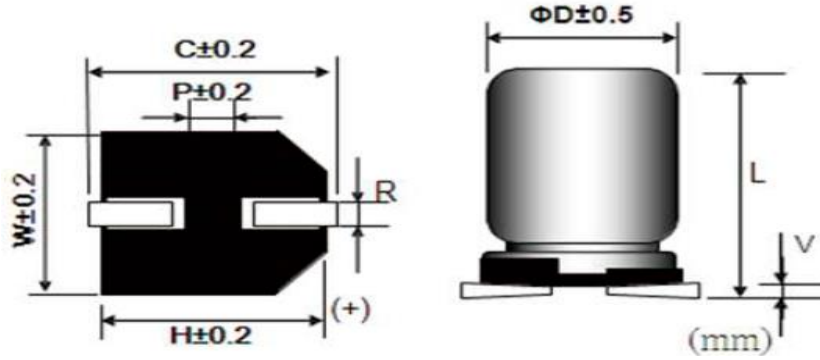

(mm)

| Size | ØD | L±0.5 | W | H | C | R | P | Vmax |
|-----------|------|-------|------|------|------|---------|-----|------|
| 8x0.5 | 8.0 | 10.5 | 8.3 | 8.3 | 9.0 | 0.7~1.1 | 3.2 | 0.3 |
| 10x10.5 | 10.0 | 10.51 | 10.3 | 10.3 | 11.0 | 1.0~1.3 | 4.5 | 0.3 |
| 12.5x13.5 | 12.5 | 13.5 | 13.0 | 13.0 | 13.7 | 1.1~1.4 | 4.5 | 0.4 |
| 16x16.5 | 16.0 | 16.5 | 17.0 | 17.0 | 18.0 | 1.4~1.8 | 6.4 | 0.4 |

Standard Ratings

D×L(mm) ; R.C.(mA RMS) at 105°C 120Hz.

| Cap (µF) | V | 160 | | 200 | | 250 | | 400 | |
|-------------|---|-----------|-------|-----------|-------|-----------|-------|-----------|-------|
| | | Item | D x l | R.C. | D x l | R.C. | D x l | R.C. | D x l |
| 2.2 | | | | | | | | 8x10.5 | 25 |
| 3.3 | | | | | | 8x10.5 | 31 | 10x10.5 | 36 |
| 4.7 | | | | | | 8x10.5 | 37 | 10x10.5 | 38 |
| 6.8 | | | | | | 8x10.5 | 44 | 12.5x13.5 | 47 |
| 10 | | 8x10.5 | 57 | 10x10.5 | 64 | 10x10.5 | 64 | 12.5x13.5 | 57 |
| 22 | | 12.5x13.5 | 112 | 12.5x13.5 | 112 | 12.5x13.5 | 112 | 16x16.5 | 115 |
| 33 | | 12.5x13.5 | 137 | 12.5x13.5 | 137 | 16x16.5 | 150 | | |
| 47 | | 16x16.5 | 180 | 16x16.5 | 180 | 16x16.5 | 180 | | |
| 68 | | 16x16.5 | 215 | 16x16.5 | 215 | | | | |
| 82 | | 16x16.5 | 235 | | | | | | |

SMDL Series

- Low impedance, 105°C 5000 hour.
- Applicable to SMT process.
- RoHS Compliance.

Specifications

| Items | Characteristics | | | | | | | | | |
|--|--|---|------|------|------|------|--------------------|---------------------------------|------|------|
| Capacitance Tolerance | ±20%(120Hz, 20°C) | | | | | | | | | |
| Operating Temperature Range | -55~+105°C | | | | | | | | | |
| Rated Voltage Range | 6.3~100VDC | | | | | | | | | |
| Capacitance Range | 22~1500μF | | | | | | | | | |
| Leakage Current | $I \leq 0.01CV$ or $3(\mu A)$, which is greater. (After 2 minutes application of DC rated voltage, at 20°C) | | | | | | | | | |
| Dissipation Factor (tanδ) | Measurement Frequency: 120Hz. Temperature: 20°C | | | | | | | | | |
| | Rated Voltage(V) | 6.3 | 10 | 16 | 25 | 35 | 50 | 63 | 80 | 100 |
| | Tan δ (Max) | 0.3 | 0.26 | 0.22 | 0.16 | 0.14 | 0.14 | 0.08 | 0.08 | 0.07 |
| Low Temperature Stability Impedance Ratio (Max) | Measurement Frequency: 120Hz. | | | | | | | | | |
| | Rated Voltage(V) | 6.3 | 10 | 16 | 25 | 35 | 50 | 63 | 80 | 100 |
| | Z(-25°C) / Z(20°C) | 4 | 3 | 2 | 2 | 2 | 2 | 2 | 2 | 2 |
| | Z(-55°C) / Z(20°C) | 8 | 5 | 4 | 3 | 3 | 3 | 3 | 3 | 3 |
| Load Life | 5000 hours, with application of rated voltage at 105°C | | | | | | | | | |
| | Capacitance Change | Within ±30% of Initial Value | | | | | | | | |
| | Tan δ | 300% or less of Initial Specified Value | | | | | | | | |
| | Leakage Current | Initial Specified Value or less | | | | | | | | |
| Shelf Life | The following specifications shall be satisfied when the capacitors are restored to 20°C after exposing them for 1000 hours at 105°C without voltage applied. Before the measurement, the capacitor shall be preconditioned by applying voltage according to them 4.1 of JISC5101-4. | | | | | | | | | |
| | Capacitance Change | Within ±30% of Initial Value | | | | | | | | |
| | Tan δ | 300% or less of Initial Specified Value | | | | | | | | |
| | Leakage Current | Initial Specified Value or less | | | | | | | | |
| Resistance to Soldering Heat | The capacitors shall be kept on the hot plate maintained at 250°C for 30 seconds. | | | | | | Capacitance Change | Within ±10% of Initial Value | | |
| | After removing from the hot plate and restored at room temperature they meet the characteristics requirements listed at right. | | | | | | Tan δ | Initial Specified Value | | |
| | | | | | | | Leakage Current | Initial Specified Value or less | | |
| Standards | JISC5101-4-1(IEC60384) | | | | | | | | | |

Frequency Coefficient of Permissible Ripple Current

| Frequency(Hz) | $120 \leq F < 1K$ | $1K \leq F < 10K$ | $10K \leq F < 100K$ | $100K \leq F$ |
|---------------|-------------------|-------------------|---------------------|---------------|
| ≤ 33 | 0.35 | 0.70 | 0.90 | 1.00 |
| 33 ~ 150 | 0.40 | 0.85 | 0.92 | 1.00 |
| > 150 | 0.60 | 0.85 | 0.95 | 1.00 |

The endurance of capacitors is reduced with internal heating produced by ripple current at the rate of halving the lifetime with every 5°C rise. When long life performance is required in actual use, the rms ripple current has to be reduced.

SMDL Series

Chip Type

Dimensions (mm)

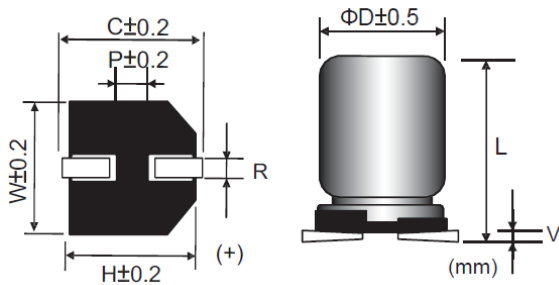

(mm)

| Size | ØD | L±0.5 | W | H | C | R | P | Vmax |
|-----------|------|----------------------|------|------|------|---------|-----|------|
| 8×10 | 8.0 | 10.0 | 8.3 | 8.3 | 9.0 | 0.7~1.1 | 3.2 | 0.3 |
| 10×10 | 10.0 | 10.0 | 10.3 | 10.3 | 11.0 | 0.7~1.3 | 4.5 | 0.3 |
| 12.5×13.5 | 12.5 | 13.5 | 13.0 | 13.0 | 13.7 | 1.1~1.4 | 4.5 | 0.4 |
| 16×16.5 | 16.0 | 16.5 | 17.0 | 17.0 | 18.0 | 1.4~1.8 | 6.4 | 0.4 |
| 18×16.5 | 18.0 | 16.5 ^{±1.0} | 19.0 | 19.0 | 20 | 1.4~1.8 | 7.0 | 0.4 |
| 18×12.5 | 18.0 | 16.5 ^{±1.0} | 19.0 | 19.0 | 20 | 1.4~1.8 | 7.0 | 0.4 |

Standard Ratings

D×L(mm);R.C.(mA rms)at105°C100KHz,IMP(Ωmax)at20°C100KHz.

| Cap I V | 6.3 | | | 10 | | | 16 | | | 25 | | | 35 | | |
|-----------|-----------|------|-------|-----------|------|-------|-----------|------|-------|-----------|------|-------|-----------|------|-------|
| (μF) Item | D x l | R.C. | IMP | D x l | R.C. | IMP | D x l | R.C. | IMP | D x l | R.C. | IMP | D x l | R.C. | IMP |
| 100 | | | | | | | | | | | | | 8x10 | 600 | 0.17 |
| 150 | | | | | | | | | | 8x10 | 600 | 0.17 | 8x10 | 600 | 0.17 |
| 220 | | | | | | | | | | 8x10 | 600 | 0.17 | 10x10 | 850 | 0.09 |
| 330 | | | | 8x10 | 600 | 0.17 | 8x10 | 600 | 0.17 | 8x10 | 600 | 0.17 | | | |
| 470 | 8x10 | 600 | 0.17 | 8x10 | 600 | 0.17 | 8x10 | 600 | 0.17 | 10x10 | 850 | 0.09 | 12.5x13.5 | 1100 | 0.06 |
| 680 | 8x10 | 600 | 0.17 | 10x10 | 850 | 0.09 | 10x10 | 850 | 0.09 | 12.5x13.5 | 1100 | 0.06 | 12.5x13.5 | 1100 | 0.06 |
| 1000 | 8x10 | 600 | 0.17 | 10x10 | 850 | 0.09 | 10x10 | 850 | 0.09 | 12.5x13.5 | 1100 | 0.06 | 16x16.5 | 1800 | 0.035 |
| | | | | | | | 12.5x13.5 | 1100 | 0.06 | | | | | | |
| 1500 | 10x10 | 850 | 0.09 | 12.5x13.5 | 1100 | 0.06 | 12.5x13.5 | 1100 | 0.06 | 16x16.5 | 1800 | 0.035 | 16x16.5 | 1800 | 0.035 |
| 2200 | 12.5x13.5 | 1100 | 0.06 | 12.5x13.5 | 1100 | 0.06 | | | | 16x16.5 | 1800 | 0.035 | 18x16.5 | 2060 | 0.033 |
| 2700 | | | | | | | | | | | | | 18x21.5 | 2060 | 0.028 |
| 3300 | | | | | | | 16x16.5 | 1800 | 0.035 | 18x16.5 | 2060 | 0.033 | | | |
| 3900 | | | | | | | | | | 18x21.5 | 2060 | 0.028 | | | |
| 4700 | | | | 16x16.5 | 1800 | 0.035 | 18x16.5 | 2060 | 0.033 | | | | | | |
| 5600 | | | | | | | 18x21.5 | 2060 | 0.028 | | | | | | |
| 6800 | 16x16.5 | 1800 | 0.035 | 18x16.5 | 2060 | 0.033 | | | | | | | | | |
| 8200 | 18x16.5 | 2060 | 0.033 | 18x21.5 | 2060 | 0.028 | | | | | | | | | |
| 10000 | 18x16.5 | 2060 | 0.033 | | | | | | | | | | | | |
| 12000 | 18x21.5 | 2060 | 0.028 | | | | | | | | | | | | |

| Cap V | 50 | | | 63 | | | 80 | | | 100 | | |
|-----------|-----------|------|-------|----------|------|-------|-----------|------|-------|-----------|------|-------|
| (μF) Item | D x l | R.C. | IMP | D x l | R.C. | IMP | D x l | R.C. | IMP | D x l | R.C. | IMP |
| 22 | | | | | | | | | | 8x10 | 130 | 1.88 |
| 33 | | | | | | | 8x10 | 130 | 1.88 | 10x10 | 200 | 0.65 |
| 47 | | | | 8x10 | 200 | 0.70 | 10x10 | 200 | 0.90 | 12.5x13.5 | 500 | 0.32 |
| 56 | 8x10 | 330 | 0.34 | 10x10 | 369 | 0.48 | | | | | | |
| 68 | 8x10 | 330 | 0.34 | | | | | | | 12.5x13.5 | 500 | 0.32 |
| 100 | 8x10 | 330 | 0.34 | 2.5x13.5 | 800 | 0.16 | 12.5x13.5 | 500 | 0.32 | 16x16.5 | 793 | 0.17 |
| 150 | 10x10 | 670 | 0.18 | 2.5x13.5 | 800 | 0.16 | 12.5x13.5 | 500 | 0.32 | 16x16.5 | 793 | 0.17 |
| 220 | | | | 2.5x13.5 | 800 | 0.16 | | | | 18x16.5 | 917 | 0.153 |
| 330 | 12.5x13.5 | 900 | 0.12 | 16x16.5 | 1410 | 0.082 | 16x16.5 | 793 | 0.17 | 18x21.5 | 1230 | 0.083 |
| 470 | 16x16.5 | 1610 | 0.073 | 16x16.5 | 1410 | 0.082 | 18x16.5 | 917 | 0.153 | | | |
| 680 | 16x16.5 | 1610 | 0.073 | 18x16.5 | 1690 | 0.080 | | | | | | |
| 1000 | 16x16.5 | 1610 | 0.073 | 18x21.5 | 1960 | 0.055 | | | | | | |
| 1200 | 18x16.5 | 1900 | 0.068 | | | | | | | | | |
| 1500 | 18x21.5 | 2100 | 0.042 | | | | | | | | | |

SMH Series

- 105°C 5000 Hours long life.
- Applicable to SMT process.
- RoHS Compliance.

Specifications

| Items | Characteristics | | | | | | | |
|---|--|---|----|--------------------|---------------------------------|----|----|--|
| Capacitance Tolerance | ±20%(120Hz, 20°C) | | | | | | | |
| Operating Temperature Range | -40~+105°C | | | | | | | |
| Rated Voltage Range | 6.3~50VDC | | | | | | | |
| Capacitance Range | 22~1000μF | | | | | | | |
| Leakage Current | I ≤0.01CVor3(μA), which is greater. (After 2 minutes application of DC rated voltage, at 20°C) | | | | | | | |
| Dissipation Factor (tan δ) | Measurement Frequency: 120Hz. Temperature: 20°C | | | | | | | |
| | Rated Voltage(V) | 6.3 | 10 | 16 | 25 | 35 | 50 | |
| | tan δ(Max) | 32 | 28 | 22 | 16 | 13 | 12 | |
| Low Temperature Stability Impedance Ratio (Max) | Measurement Frequency: 120Hz. | | | | | | | |
| | Rated Voltage(V) | 6.3 | 10 | 16 | 25 | 35 | 50 | |
| | Z(-25°C) / Z(20°C) | 4 | 3 | 2 | 2 | 2 | 2 | |
| | Z(-40°C) / Z(20°C) | 10 | 7 | 5 | 3 | 3 | 3 | |
| Load Life | 5000 hours, with application of rated voltage at 105°C | | | | | | | |
| | Capacitance Change | Within ±30% of Initial Value | | | | | | |
| | tan δ | 300% or less of Initial Specified Value | | | | | | |
| | Leakage Current | Initial Specified Value or less | | | | | | |
| Shelf Life | The following specifications shall be satisfied when the capacitors are restored to 20°C after exposing them for 1,000 hours at 105°C without voltage applied. Before the measurement, the capacitor shall be preconditioned by applying voltage according to them 4.1 of JIS C5101-4. | | | | | | | |
| | Capacitance Change | Within ±300% of Initial Value | | | | | | |
| | tan δ | 300% or less of Initial Specified Value | | | | | | |
| | Leakage Current | Initial Specified Value or less | | | | | | |
| Resistance to Soldering Heat | The capacitors shall be kept on the hot plate maintained at 250°C for 30 seconds. | | | Capacitance Change | Within ±10% Of Initial Value | | | |
| | After removing from the hot plate and restored at room temperature they meet the characteristics requirements listed at right. | | | tan δ | Initial Specified Value | | | |
| | | | | Leakage Current | Initial Specified Value or less | | | |
| Standards | JIS C 5101-4-1(IEC60384) | | | | | | | |

Frequency Coefficient of Permissible Ripple Current

| Capacitance (μF) | Frequency (Hz) | | | |
|------------------|----------------|--------------|----------------|----------|
| | 100 ≤ F < 1K | 1K ≤ F < 10K | 10K ≤ F < 100K | 100K ≤ F |
| 4.7 ~ 33 | 1.00 | 1.20 | 1.30 | 1.45 |
| >33 | 1.00 | 1.10 | 1.20 | 1.30 |

The endurance of capacitors is reduced with internal heating produced by ripple current at the rate of having the lifetime with every 5°C rise. When long life performance is required in actual use, the rms ripple current has to be reduced.

SMH Series

Chip Type
Dimensions (mm)

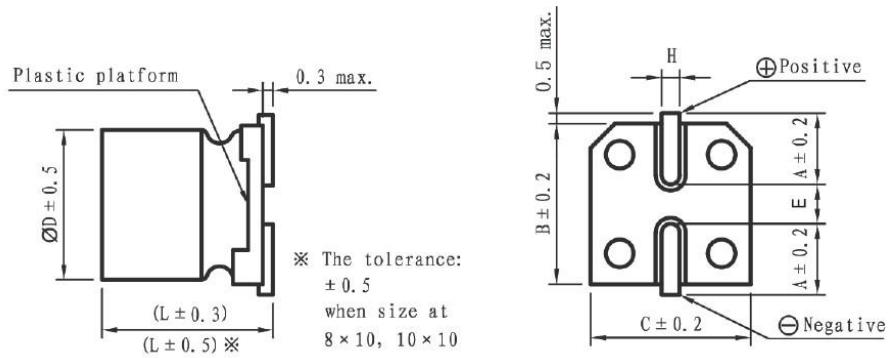

(mm)

| $\varnothing D \times L$ | 8x10 | 10x1 |
|--------------------------|---------|---------|
| A | 2.9 | 3.2 |
| B | 8.3 | 10.3 |
| C | 8.3 | 10.3 |
| E | 3.1 | 4.5 |
| L | 10 | 10 |
| H | 0.8~1.1 | 0.8~1.1 |

Standard Ratings

D×L(mm); R.C. (mA rms) at 105°C/120Hz

| Cap(μF) | V | 6.3 | | 10 | | 16 | | 25 | | 35 | | 50 | |
|---------|------|-------|------|-------|------|-------|------|-------|------|-------|------|-------|------|
| | Item | Dx L | R.C. | D x L | R.C. | D x L | R.C. | D x L | R.C. | D x L | R.C. | D XL | R.C. |
| 22 | | | | | | | | | | | | | |
| 33 | | | | | | | | | | | | 8x10 | 80 |
| 47 | | | | | | | | | | 8x10 | 92 | 8x10 | 95 |
| 100 | | | | | | | | 8x10 | 116 | 10x10 | 150 | 10x10 | 160 |
| 220 | | | | 8x10 | 140 | 10x10 | 216 | 10x10 | 240 | 10x10 | 280 | | |
| 330 | | 8x10 | 160 | 10x10 | 240 | 10x10 | 300 | 10x10 | 375 | | | | |
| 470 | | 10x10 | 260 | 10x10 | 280 | 10x10 | 320 | | | | | | |
| 1000 | | 10x10 | 340 | | | | | | | | | | |

SMJ Series

- Chip type with 6.3Ø~16Ø, 125°C, 2,000 hours, long life product
- Designed For automobile modules and other high temperature applications.
- RoHS Compliance.
- 6.3Ø~16ØV-Chip, 125°C, 2,000

Specifications

| Items | Characteristics | | | | | | | | |
|------------------------------|---|------|------|---|--------------------|------|---------------------------------|------|------|
| Capacitance Tolerance | ± 20% (120Hz, 20°C) | | | | | | | | |
| Operating Temperature Range | -55 ~ +125°C | | | | | | | | |
| Rated Voltage Range | 6.3~100VDC | | | | | | | | |
| Capacitance Range | 1 ~ 4700µF | | | | | | | | |
| Leakage Current | $I \leq 0.01CV$ or 3(µA), which is greater. (After 3 minutes application of DC rated voltage, at 20°C) | | | | | | | | |
| Dissipation Factor (tan δ) | Measurement Frequency: 120Hz. Temperature: 20°C | | | | | | | | |
| | Rated Voltage(V) | 6.3 | 10 | 16 | 25 | 35 | 50 | 63 | 100 |
| | tan δ(Max) | 0.30 | 0.24 | 0.20 | 0.16 | 0.14 | 0.14 | 0.12 | 0.10 |
| Low Temperature Stability | Measurement Frequency: 120Hz. | | | | | | | | |
| | Rated Voltage(V) | 6.3 | 10 | 16 | 25 | 35 | 50 | 63 | 100 |
| Impedance Ratio (Max) | Z(-25°C) / Z(20°C) | 4 | 3 | 2 | 2 | 2 | 2 | 2 | 2 |
| | Z(-40°C) / Z(20°C) | 8 | 6 | 4 | 3 | 3 | 3 | 3 | 3 |
| Load Life | 6.3V~50V:2,000hours (ΦD =6.3mm1,000hours); 63V~100V:1,500 hours with application of rated voltage at 125°C | | | | | | | | |
| | Capacitance Change | | | Within ± 30% of Initial Value | | | | | |
| | tan δ | | | 300% or less of Initial Specified Value | | | | | |
| | Leakage Current | | | Initial Specified Value or less | | | | | |
| Shelf Life | The following specifications shall be satisfied when the capacitors are restored to 20°C after exposing them for 1,000 hours 125°C without voltage applied. Before the measurement, the capacitor shall be preconditioned by applying voltage | | | | | | | | |
| | Capacitance Change | | | Within ± 30% of Initial Value | | | | | |
| | tan δ | | | 300% or less of Initial Specified Value | | | | | |
| | Leakage Current | | | Initial Specified Value or less | | | | | |
| Resistance to Soldering Heat | The capacitors shall be kept on the hot plate maintained at 250°C for 30 seconds. After removing from the hot plate and restored at room temperature they meet the characteristics requirements listed at right. | | | | Capacitance Change | | Within ±10% of Initial Value | | |
| | | | | | tan δ | | Initial Specified Value | | |
| | | | | | Leakage Current | | Initial Specified Value or less | | |
| Standards | Black print on the case top | | | | | | | | |

Frequency Coefficient of Permissible Ripple Current

| Capacitance (µF) | Frequency (Hz) | | | |
|------------------|----------------|--------------|----------------|----------|
| | 100 ≤ F < 1K | 1K ≤ F < 10K | 10K ≤ F < 100K | 100K ≤ F |
| C ≤ 22 | 0.50 | 0.80 | 0.90 | 1.00 |
| 22 < C ≤ 150 | 0.65 | 0.85 | 0.92 | 1.00 |
| 150 < C | 0.70 | 0.85 | 0.95 | 1.00 |

The endurance of capacitors is reduced with internal heating produced by ripple current at the rate of having the lifetime with every 5°C rise. When long life performance is required in actual use, the rms ripple current has to be reduced.

SMJ Series

Chip Type

Dimensions (mm)

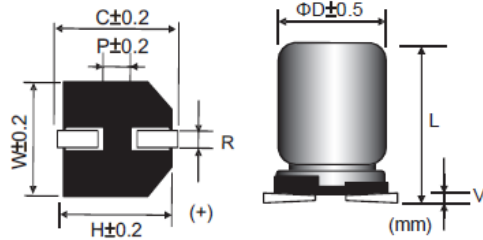

| Size | ØD | L±0.5 | W | H | C | R | P | Vmax |
|-----------|------|----------|------|------|------|---------|-----|------|
| 6.3x6 | 6.3 | 6.0±0.3 | 6.6 | 6.6 | 7.3 | 0.5~0.8 | 2.1 | 0.3 |
| 6.3x7.7 | 6.3 | 7.7±0.3 | 6.6 | 6.6 | 7.3 | 0.5~0.8 | 2.1 | 0.3 |
| 8x10 | 8.0 | 10.0±0.5 | 8.3 | 8.3 | 9.0 | 0.7~1.1 | 3.2 | 0.3 |
| 10x10 | 10.0 | 10.0±0.5 | 10.3 | 10.3 | 11.0 | 0.7~1.3 | 4.5 | 0.3 |
| 12.5x13.5 | 12.5 | 13.5±0.5 | 13.0 | 13.0 | 13.7 | 1.1~1.4 | 4.5 | 0.4 |
| 16x16.5 | 16.0 | 16.5±0.5 | 17.0 | 17.0 | 18.0 | 1.1~1.8 | 6.4 | 0.4 |

Standard Ratings

DxL(mm): R.C. (mA rms) at 105°C 100KHz, IMP (Ω max) at 20°C 100KHz

| Cap(µF) | V Item | 6.3 | | | 10 | | | 16 | | | 25 | | |
|---------|-----------|-----------|------|------|-----------|------|-------|-----------|------|-------|-----------|------|-------|
| | | D x L | R.C. | IMP | DxL | R.C. | IMP | D x L | R.C. | IMP | D x L | R.C. | IMP |
| 33 | | | | | | | | | | | 6.3x6.0 | 70 | 1.6 |
| 47 | | | | | 6.3x6.0 | 70 | 1.6 | 6.3x6 | 70 | 1.6 | 6.3x7.7 | 110 | 0.90 |
| 100 | | 6.3x6.0 | 70 | 1.6 | 6.3x7.7 | 110 | 0.90 | 8x10 | 160 | 0.40 | 6.3x7.7 | 110 | 0.90 |
| | | | | | | | | | | | 8x10 | 160 | 0.40 |
| 220 | | 6.3x7.7 | 110 | 0.90 | 6.3x7.7 | 110 | 0.90 | 8x10 | 160 | 0.40 | 8x10 | 160 | 0.40 |
| | | | | | 8x10 | 160 | 0.40 | 8x10 | 160 | 0.40 | 10x10 | 220 | 0.30 |
| 330 | | 8x10 | 160 | 0.40 | 8x10 | 160 | 0.40 | 10x10 | 220 | 0.30 | 10x10 | 220 | 0.30 |
| | | | | | | | | | | | 12.5x13.5 | 550 | 0.12 |
| 470 | | 8x10 | 160 | 0.40 | 10x10 | 220 | 0.30 | 12.5x13.5 | 550 | 0.12 | 12.5x13.5 | 550 | 0.12 |
| 680 | | 10x10 | 220 | 0.30 | 12.5x13.5 | 550 | 0.12 | 12.5x13.5 | 550 | 0.12 | 12.5x13.5 | 550 | 0.12 |
| 1000 | | 12.5x13.5 | 550 | 0.12 | 12.5x13.5 | 550 | 0.12 | 12.5x13.5 | 550 | 0.12 | 16x16.5 | 900 | 0.080 |
| 1500 | | 12.5x13.5 | 550 | 0.12 | 12.5x13.5 | 550 | 0.12 | 16x16.5 | 900 | 0.080 | 16x16.5 | 900 | 0.080 |
| 2200 | | 12.5x13.5 | 550 | 0.12 | 16x16.5 | 900 | 0.080 | 16x16.5 | 900 | 0.080 | | | |
| 3300 | | 16x16.5 | 900 | 0.08 | 16x16.5 | 900 | 0.080 | | | | | | |
| 4700 | | 16x16.5 | 900 | 0.08 | | | | | | | | | |

| Cap (µF) | V | 35 | | | 50 | | | 63 | | | 100 | | |
|-------------|---|-----------|-------|-------|-----------|---------|------|-----------|-------|-------|-----------|-------|-------|
| | | Item | D x L | R.C. | IMP | D x L | R.C. | IMP | D x L | R.C. | IMP | D x L | R.C. |
| 1 | | | | | 6.3x6.0 | 45 | 3.5 | | | | | | |
| 2.2 | | | | | 6.3x6.0 | 45 | 3.5 | | | | | | |
| 3.3 | | | | | 6.3x6.0 | 45 | 3.5 | | | | | | |
| 4.7 | | 6.3x6.0 | 60 | 2.0 | 6.3x6.0 | 45 | 3.5 | | | | | | |
| 10 | | 6.3x6.0 | 70 | 1.6 | 6.3x6.0 | 50 | 2.8 | | | | 8x10 | 70 | 1.00 |
| 22 | | 6.3x6.0 | 70 | 1.6 | 6.3x7.7 | 80 | 2.0 | 8x10 | 100 | 1.00 | 8x10 | 70 | 1.00 |
| 33 | | 6.3x7.7 | 110 | 0.90 | 6.3x7.7 | 80 | 2.0 | 8x10 | 100 | 1.00 | 10x10 | 115 | 0.80 |
| | | | | | 8x10 | 140 | 0.70 | | | | | | |
| 47 | | 6.3x7.7 | 110 | 0.90 | 8x10 | 140 | 0.70 | 8x10 | 100 | 1 | 12.5x13.5 | 350 | 0.33 |
| | | 8x10 | 160 | 0.40 | 10x10 | 240 | 0.50 | 10x10 | 150 | 0.5 | | | |
| 100 | | 8x10 | 160 | 0.40 | 10x10 | 240 | 0.50 | 10x10 | 150 | 0.5 | 16x16.5 | 500 | 0.240 |
| | | 10x10 | 220 | 0.30 | 12.5x13.5 | 490 | 0.23 | 12.5x13.5 | 350 | 0.250 | | | |
| 220 | | 10x10 | 220 | 0.30 | 12.5x13.5 | 490 | 0.23 | 12.5x13.5 | 350 | 0.250 | | | |
| | | 12.5x13.5 | 550 | 0.12 | | 16x16.5 | 500 | 0.18 | | | | | |
| 330 | | 12.5x13.5 | 550 | 0.12 | 12.5x13.5 | 490 | 0.23 | 16x16.5 | 500 | 0.18 | | | |
| | | | | | 16x16.5 | 800 | 0.15 | | | | | | |
| 470.0 | | 12.5x13.5 | 550 | 0.12 | 16x16.5 | 800 | 0.15 | 16x16.5 | 500 | 0.18 | | | |
| | | 16x16.5 | 900 | 0.080 | | | | | | | | | |
| 680.0 | | 16x16.5 | 900 | 0.080 | 16x16.5 | 800 | 0.15 | | | | | | |
| 1000.0 | | 16x16.5 | 900 | 0.080 | | | | | | | | | |

SMK Series

- Chip type with 8Ø~16Ø, 125°C, 2,000 hours, long life product
- Peak acceleration: 30G
- RoHS Compliance.

Specifications

| Items | Characteristics | | | | | | | | |
|------------------------------|---|---|------|------|--------------------|------|---------------------------------|------|------|
| Capacitance Tolerance | ± 20% (120Hz, 20°C) | | | | | | | | |
| Operating Temperature Range | -55 ~ +125°C | | | | | | | | |
| Rated Voltage Range | 6.3~100VDC | | | | | | | | |
| Capacitance Range | 1 ~ 4700µF | | | | | | | | |
| Leakage Current | I ≤ 0.01CV or 3(µA) , which is greater. (After 3 minutes application of DC rated voltage, at 20°C) | | | | | | | | |
| Dissipation Factor (tan δ) | Measurement Frequency: 120Hz. Temperature: 20°C | | | | | | | | |
| | Rated Voltage(V) | 6.3 | 10 | 16 | 25 | 35 | 50 | 63 | 100 |
| | tan δ(Max) | 0.30 | 0.24 | 0.20 | 0.16 | 0.14 | 0.14 | 0.12 | 0.10 |
| Low Temperature Stability | Measurement Frequency: 120Hz. | | | | | | | | |
| | Rated Voltage(V) | 6.3 | 10 | 16 | 25 | 35 | 50 | 63 | 100 |
| Impedance Ratio (Max) | Z(-25°C)/Z(20°C) | 4 | 3 | 2 | 2 | 2 | 2 | 2 | 2 |
| | Z(-40°C)/Z(20°C) | 8 | 6 | 4 | 3 | 3 | 3 | 3 | 3 |
| Load Life | 6.3V~50V: 2,000hours; 63V~100V: 1,500 hours with application of rated voltage at 125°C | | | | | | | | |
| | Capacitance Change | Within ± 30% of Initial Value | | | | | | | |
| | tan δ | 300% or less of Initial Specified Value | | | | | | | |
| | Leakage Current | Initial Specified Value or less | | | | | | | |
| Shelf Life | The following specifications shall be satisfied when the capacitors are restored to 20°C after exposing them for 1,000 hours 125°C without voltage applied. Before the measurement, the capacitor shall be preconditioned by applying voltage according to them 4.1 of JIS C5101-4. | | | | | | | | |
| | Capacitance Change | Within ± 300% of Initial Value | | | | | | | |
| | tan δ | 300% or less of Initial Specified Value | | | | | | | |
| | Leakage Current | Initial Specified Value or less | | | | | | | |
| Resistance to Soldering Heat | The capacitors shall be kept on the hot plate maintained at 250°C for 30 seconds. After removing from the hot plate and restored at room temperature they meet the characteristics requirements listed at right. | | | | Capacitance Change | | Within ±10% of Initial Value | | |
| | | | | | tan δ | | Initial Specified Value | | |
| | | | | | Leakage Current | | Initial Specified Value or less | | |
| Standards | Black print on the case top | | | | | | | | |

Frequency Coefficient of Permissible Ripple Current

| Capacitance (µF) | Frequency (Hz) | | | |
|------------------|----------------|--------------|----------------|----------|
| | 100 ≤ F < 1K | 1K ≤ F < 10K | 10K ≤ F < 100K | 100K ≤ F |
| C ≤ 22 | 0.50 | 0.80 | 0.90 | 1.00 |
| 22 < C ≤ 150 | 0.65 | 0.85 | 0.92 | 1.00 |
| 150 < C | 0.70 | 0.85 | 0.95 | 1.00 |

The endurance of capacitors is reduced with internal heating produced by ripple current at the rate of having the lifetime with every 5°C rise. When long life performance is required in actual use, the rms ripple current has to be reduced.

SMK Series

Chip Type
Dimensions (mm)

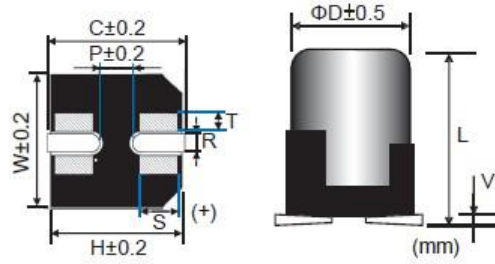

(mm)

| Size | ØD | L | W | H | C | R | P | S | T | Vmax |
|-----------|------|----------|------|------|------|---------|-----|-----|-----|------|
| 8x10.5 | 8.0 | 10.5±0.5 | 8.3 | 8.3 | 9.0 | 0.7~1.1 | 3.2 | 0.7 | 1.3 | 0.3 |
| 10x10.5 | 10.0 | 10.5±0.5 | 10.3 | 10.3 | 11.0 | 1.0~1.4 | 4.5 | 0.7 | 1.3 | 0.3 |
| 12.5x13.5 | 12.5 | 13.5±1.0 | 13.5 | 13.5 | 14.2 | 1.1~1.4 | 4.5 | 2.2 | 2.4 | 0.4 |
| 16x16.5 | 16.0 | 16.5±1.0 | 17.0 | 17.0 | 18.0 | 1.4~1.8 | 6.4 | 3.0 | 2.0 | 0.4 |

Standard Ratings

DxL(mm): R.C.(mA rms) at 125°C 100KHz, IMP(Ω max) at 20°C 100KHz

| Cap(µF) | V | 6.3 | | | | 10 | | | 16 | | | 25 | | |
|---------|---|-----------|-------|-------|-----------|-------|-------|-----------|-------|-------|-----------|-------|-------|-----|
| | | Item | D x L | R.C. | IMP | D x L | R.C. | IMP | D x L | R.C. | IMP | D x L | R.C. | IMP |
| 100 | | | | | | | | 8x10.5 | 160 | 0.40 | 8x10.5 | 160 | 0.40 | |
| 220 | | | | | 8x10.5 | 160 | 0.40 | 8x10.5 | 160 | 0.40 | 8x10.5 | 160 | 0.40 | |
| 330 | | 8x10.5 | 160 | 0.40 | 8x10.5 | 160 | 0.40 | 10x10.5 | 220 | 0.30 | 10x10.5 | 220 | 0.30 | |
| 470 | | 8x10.5 | 160 | 0.40 | 10x10.5 | 220 | 0.30 | 12.5x13.5 | 550 | 0.12 | 12.5x13.5 | 550 | 0.12 | |
| 680 | | 10x10.5 | 220 | 0.30 | 12.5x13.5 | 550 | 0.12 | 12.5x13.5 | 550 | 0.12 | 12.5x13.5 | 550 | 0.12 | |
| 1000 | | 12.5x13.5 | 550 | 0.12 | 12.5x13.5 | 550 | 0.12 | 12.5x13.5 | 550 | 0.12 | 16x16.5 | 900 | 0.080 | |
| 1500 | | 12.5x13.5 | 550 | 0.12 | 12.5x13.5 | 550 | 0.12 | 16x16.5 | 900 | 0.080 | 16x16.5 | 900 | 0.080 | |
| 2200 | | 12.5x13.5 | 550 | 0.12 | 16x16.5 | 900 | 0.080 | 16x16.5 | 900 | 0.080 | | | | |
| 3300 | | 16x16.5 | 900 | 0.08 | 16x16.5 | 900 | 0.080 | | | | | | | |
| 4700 | | 16x16.5 | 900 | 0.08 | | | | | | | | | | |
| Cap(µF) | V | 35 | | | 50 | | | 63 | | | 100 | | | |
| | | Item | D x L | R.C. | IMP | D x L | R.C. | IMP | D x L | R.C. | IMP | D x L | R.C. | IMP |
| 10 | | | | | | | | | | | 8x10.5 | 70 | 1.00 | |
| 22 | | | | | | | | 8x10.5 | 100 | 1.00 | 8x10.5 | 70 | 1.00 | |
| 33 | | | | | 8x10.5 | 140 | 0.70 | 8x10.5 | 100 | 1.00 | 10x10.5 | 115 | 0.80 | |
| 47 | | 8x10.5 | 160 | 0.40 | 8x10.5 | 140 | 0.70 | 8x10.5 | 100 | 1.00 | 12.5x13.5 | 350 | 0.33 | |
| 100 | | 8x10.5 | 160 | 0.40 | 10x10.5 | 240 | 0.50 | 10x10.5 | 150 | 0.50 | 16x16.5 | 500 | 0.24 | |
| | | 10x10.5 | 220 | 0.30 | 12.5x13.5 | 490 | 0.23 | 12.5x13.5 | 350 | 0.25 | | | | |
| 220 | | 10x10.5 | 220 | 0.30 | 12.5x13.5 | 490 | 0.23 | 12.5x13.5 | 350 | 0.25 | | | | |
| | | 12.5x13.5 | 550 | 0.12 | | | | 16x16.5 | 500 | 0.18 | | | | |
| 330 | | 12.5x13.5 | 550 | 0.12 | 12.5x13.5 | 490 | 0.23 | 16x16.5 | 500 | 0.18 | | | | |
| | | | | | 16x16.5 | 800 | 0.15 | | | | | | | |
| 470.0 | | 12.5x13.5 | 550 | 0.12 | 16x16.5 | 800 | 0.15 | 16x16.5 | 500 | 0.18 | | | | |
| | | 16x16.5 | 900 | 0.080 | | | | | | | | | | |
| 680.0 | | 16x16.5 | 900 | 0.080 | 16x16.5 | 800 | 0.15 | | | | | | | |
| 1000.0 | | 16x16.5 | 900 | 0.080 | | | | | | | | | | |

SML Series

- Chip type with 8Ø~16Ø, 125°C, 5,000 hours, long life product
- Designed For automobile modules and other high temperature applications
- RoHS Compliance.

Specifications

| Items | Characteristics | | | | |
|------------------------------|---|---|--------------------|---------------------------------|------|
| Capacitance Tolerance | ± 20% (120Hz, 20°C) | | | | |
| Operating Temperature Range | -40 ~ +125°C | | | | |
| Rated Voltage Range | 16~50VDC | | | | |
| Capacitance Range | 33 ~ 2200µF | | | | |
| Leakage Current | I ≤ 0.01CV or 3(µA) , which is greater. (After 2 minutes application of DC rated voltage, at 20°C) | | | | |
| Dissipation Factor (tan δ) | Measurement Frequency: 120Hz. Temperature: 20°C | | | | |
| | Rated Voltage(V) | 16 | 25 | 35 | 50 |
| | tan δ(Max) | 0.20 | 0.20 | 0.14 | 0.14 |
| Low Temperature Stability | Measurement Frequency: 120Hz. | | | | |
| | Rated Voltage(V) | 16 | 25 | 35 | 50 |
| Impedance Ratio (Max) | Z (-25°C)/Z(20°C) | 5 | 2 | 2 | 2 |
| | Z (-40°C)/Z (20°C) | 8 | 4 | 3 | 3 |
| Load Life | Φ 8~Φ10:2000hours; Φ12.5:3000 hours; Φ16:5000hours with application of rated voltage at 125°C | | | | |
| | Capacitance Change | Within ± 30% of Initial Value | | | |
| | tan δ | 300% or less of Initial Specified Value | | | |
| | Leakage Current | Initial Specified Value or less | | | |
| Shelf Life | The following specifications shall be satisfied when the capacitors are restored to 20°C after exposing them for 1,000 hours 125°C without voltage applied. Before the measurement, the capacitor shall be preconditioned by applying voltage according to them 4.1 of JIS C5101-4. | | | | |
| | Capacitance Change | Within ± 300% of Initial Value | | | |
| | tan δ | 300% or less of Initial Specified Value | | | |
| | Leakage Current | Initial Specified Value or less | | | |
| Resistance to Soldering Heat | The capacitors shall be kept on the hot plate maintained at 250°C for 30 seconds. After removing from the hot plate and restored at room temperature they meet the characteristics requirements listed at right. | | Capacitance Change | Within ±10% of Initial Value | |
| | | | tan δ | Initial Specified Value | |
| | | | Leakage Current | Initial Specified Value or less | |
| Standards | Black print on the case top | | | | |

Frequency Coefficient of Permissible Ripple Current

| Capacitance (µF) | Frequency(Hz) | | | |
|------------------|---------------|--------------|----------------|----------|
| | 100 ≤ F < 1K | 1K ≤ F < 10K | 10K ≤ F < 100K | 100K ≤ F |
| All Series | 0.60 | 0.85 | 0.93 | 1.00 |

The endurance of capacitors is reduced with internal heating produced by ripple current at the rate of having the lifetime with every 5°C rise. When long life performance is required in actual use, the rms ripple current has to be reduced.

SML Series

Chip Type
Dimensions (mm)

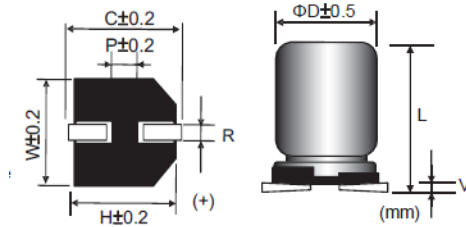

(mm)

| Size | ØD | L | W | H | C | R | P | Vmax |
|-----------|------|----------|------|------|------|---------|-----|------|
| 6.3x6.0 | 6.3 | 6.0±0.3 | 6.6 | 6.6 | 7.2 | 0.5~0.8 | 2.1 | 0.3 |
| 6.3x7.7 | 6.3 | 7.7±0.3 | 6.6 | 6.6 | 7.2 | 0.5~0.8 | 2.1 | 0.3 |
| 8x10 | 8.0 | 10±0.5 | 8.3 | 8.3 | 9.0 | 0.7~1.1 | 3.2 | 0.3 |
| 10x10 | 10.0 | 10±0.5 | 10.3 | 10.3 | 11.0 | 0.7~1.1 | 4.5 | 0.3 |
| 12.5x13.5 | 12.5 | 13.5±0.5 | 13.0 | 13.0 | 13.7 | 1.1~1.4 | 4.5 | 0.4 |
| 16><16.5 | 16.0 | 16.5±0.5 | 17.0 | 17.0 | 18.0 | 1.4~1.8 | 6.4 | 0.4 |
| 18><16.5 | 18.0 | 16.5±1.0 | 19.0 | 19.0 | 20.0 | 1.4~1.8 | 7.0 | 0.4 |
| 18x21.5 | 18.0 | 21.5±1.0 | 19.0 | 19.0 | 20.0 | 1.4~1.8 | 7.0 | 0.4 |

Standard Ratings

D X L(MM); R.C. (mA rms) at 105°C 100KHz, IMP (O max) at 20°C 100KHz

| Cap(µF) | V | 16.0 | | | 25 | | | 35 | | | 50 | | |
|---------|-----------|-------|------|-------|-----------|------|-------|-----------|------|-------|-----------|------|------|
| | Item | D x L | R.C. | IMP | D x L | R.C. | IMP | D x L | R.C. | IMP | D x L | R.C. | IMP |
| 10 | | | | | | | | | | | 6.3x6.0 | 70 | 2.00 |
| 22 | | | | | | | | 6.3x6.0 | 110 | 1.60 | | | |
| 33 | | | | | 6.3x6.0 | 110 | 1.60 | 6.3x6.0 | 110 | 1.60 | | | |
| | | | | | | | | 6.3x7.7 | 200 | 0.45 | | | |
| 47 | 6.3x6.0 | | 110 | 1.60 | | | | 6.3x7.7 | 200 | 0.45 | 8x10 | 250 | 0.45 |
| 100 | 6.3x7.7 | | 200 | 0.45 | 6.3x7.7 | 200 | 0.45 | 8x10 | 300 | 0.18 | 10x10 | 350 | 0.30 |
| 160 | | | | | | | | 8x10 | 300 | 0.18 | | | |
| 220 | | | | | 8x10 | 300 | 0.18 | 10x10 | 500 | 0.11 | 12.5x13.5 | 700 | 0.15 |
| 270 | | | | | 8x10 | 300 | 0.18 | | | | | | |
| 300 | | | | | | | | 10x10 | 500 | 0.11 | | | |
| 330 | 8x10 | | 300 | 0.18 | 10x10 | 500 | 0.11 | 12.5x13.5 | 1200 | 0.08 | | | |
| 390 | 8x10 | | 300 | 0.18 | | | | | | | | | |
| 470 | 10x10 | | 500 | 0.11 | 10x10 | 500 | 0.11 | 12.5x13.5 | 1200 | 0.08 | 16x16.5 | 1000 | 0.09 |
| 620 | | | | | | | | 12.5x13.5 | 1200 | 0.08 | | | |
| 680 | 10x10 | | 500 | 0.11 | 12.5x13.5 | 1200 | 0.08 | 16x16.5 | 1800 | 0.05 | 18x16.5 | 1200 | 0.07 |
| 910 | | | | | 12.5x13.5 | 1200 | 0.08 | | | | | | |
| 1000 | 12.5x13.5 | | 1200 | 0.08 | 16x16.5 | 1800 | 0.05 | 16x16.5 | 1800 | 0.05 | 18x21.5 | 1650 | 0.05 |
| 1500 | 12.5x13.5 | | 1200 | 0.08 | 16x16.5 | 1800 | 0.05 | 18x16.5 | 2000 | 0.045 | | | |
| 2200 | 16x16.5 | | 1800 | 0.05 | 18x21.5 | 2000 | 0.045 | 18x21.5 | 2200 | 0.04 | | | |
| 3300 | 18x16.5 | | 2000 | 0.045 | 18x21.5 | 2200 | 0.04 | | | | | | |
| 3900 | 18x21.5 | | 2200 | 0.04 | | | | | | | | | |

SMM Series

- Chip type with 8Ø~16Ø, 125°C, 5,000 hours, long life product
- Designed For automobile modules and other high temperature applications
- Peak acceleration: 30G
- RoHS Compliance.

Specifications

| Items | Characteristics | | | | |
|------------------------------|---|---|--------------------|---------------------------------|------|
| Capacitance Tolerance | ± 20% (120Hz, 20°C) | | | | |
| Operating Temperature Range | -40 ~ +125°C | | | | |
| Rated Voltage Range | 16~50VDC | | | | |
| Capacitance Range | 33 ~ 2200µF | | | | |
| Leakage Current | I ≤ 0.01CV or 3(µA) , which is greater. (After 2 minutes application of DC rated voltage, at 20°C) | | | | |
| Dissipation Factor (tan δ) | Measurement Frequency: 120Hz. Temperature: 20°C | | | | |
| | Rated Voltage(V) | 16 | 25 | 35 | 50 |
| | tan δ(Max) | 0.20 | 0.20 | 0.14 | 0.14 |
| Low Temperature Stability | Measurement Frequency: 120Hz. | | | | |
| | Rated Voltage(V) | 16 | 25 | 35 | 50 |
| Impedance Ratio (Max) | Z(-25°C)Z(20°C) | 5 | 2 | 2 | 2 |
| | Z(-40°C)Z(20°C) | 8 | 4 | 3 | 3 |
| Load Life | Φ 8~Φ10:2000hours; Φ12.5:3000 hours; Φ16:5000hours with application of rated voltage at 125°C | | | | |
| | Capacitance Change | Within ± 30% of Initial Value | | | |
| | tan δ | 300% or less of Initial Specified Value | | | |
| | Leakage Current | Initial Specified Value or less | | | |
| Shelf Life | The following specifications shall be satisfied when the capacitors are restored to 20°C after exposing them for 1,000 hours 125°C without voltage applied. Before the measurement, the capacitor shall be preconditioned by applying voltage according to them 4.1 of JIS C5101-4. | | | | |
| | Capacitance Change | Within ± 300% of Initial Value | | | |
| | tan δ | 300% or less of Initial Specified Value | | | |
| | Leakage Current | Initial Specified Value or less | | | |
| Resistance to Soldering Heat | The capacitors shall be kept on the hot plate maintained at 250°C for 30 seconds. After removing from the hot plate and restored at room temperature they meet the characteristics requirements listed at right. | | Capacitance Change | Within ±10% of Initial Value | |
| | | | tan δ | Initial Specified Value | |
| | | | Leakage Current | Initial Specified Value or less | |
| Standards | Black print on the case top | | | | |

Frequency Coefficient of Permissible Ripple Current

| Capacitance (µF) | Frequency (Hz) | | | |
|------------------|----------------|--------------|----------------|----------|
| | 100 ≤ F < 1K | 1K ≤ F < 10K | 10K ≤ F < 100K | 100K ≤ F |
| All series | 0.60 | 0.85 | 0.93 | 1.00 |

The endurance of capacitors is reduced with internal heating produced by ripple current at the rate of having the lifetime with every 5°C rise. When long life performance is required in actual use, the rms ripple current has to be reduced.

SMM Series

Chip Type

Dimensions (mm)

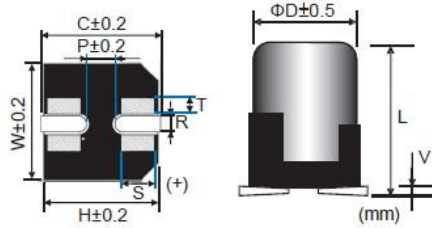

(mm)

| Size | ØD | L | W | H | C | R | P | S | T | Vmax |
|-----------|------|----------|------|------|------|---------|-----|-----|-----|------|
| 8x10.5 | 8.0 | 10.5±0.5 | 8.3 | 8.3 | 9.0 | 1.0~1.4 | 3.2 | 0.7 | 1.3 | 0.3 |
| 10x10.5 | 10.0 | 10.5±0.5 | 10.3 | 10.3 | 11.0 | 1.0~1.4 | 4.5 | 0.7 | 1.3 | 0.3 |
| 12.5x13.5 | 12.5 | 13.5±1.0 | 13.5 | 13.5 | 14.2 | 1.0~1.4 | 4.5 | 2.2 | 2.4 | 0.4 |
| 16x16.5 | 16.0 | 16.5±1.0 | 17.0 | 17.0 | 18.0 | 1.4~1.8 | 6.4 | 3.0 | 2.0 | 0.4 |

Standard Ratings

DxL(mm) ; R.C.(mA rms) at 125°C 100KHz, IMP(Ω max) at 20°C 100KHz

| Cap (µF) | V | 16.0 | | | 25 | | | 35 | | | 50 | | |
|----------|------|-----------|------|------|-----------|------|------|-----------|------|------|-----------|------|------|
| | Item | D x L | R.C. | IMP | D x L | R.C. | IMP | D x L | R.C. | IMP | D x L | R.C. | IMP |
| 47 | | | | | | | | | | | 8x10.5 | 250 | 0.5 |
| 100 | | | | | | | | 8x10.5 | 300 | 0.18 | 10x10.5 | 350 | 0.30 |
| 160 | | | | | | | | 8x10.5 | 300 | 0.18 | | | |
| 220 | | | | | 8x10.5 | 300 | 0.18 | 10x10.5 | 500 | 0.11 | 12.5x13.5 | 700 | 0.15 |
| 270 | | | | | 8x10.5 | 300 | 0.18 | | | | | | |
| 300 | | | | | | | | 10x10.5 | 500 | 0.11 | | | |
| 330 | | 8x10.5 | 300 | 0.18 | 10x10.5 | 500 | 0.11 | 12.5x13.5 | 1200 | 0.08 | | | |
| 390 | | 8x10.5 | 300 | 0.18 | | | | | | | | | |
| 470 | | 10x10.5 | 500 | 0.11 | 10x10.5 | 500 | 0.11 | 12.5x13.5 | 1200 | 0.08 | 16x16.5 | 1000 | 0.09 |
| 620 | | | | | | | | 12.5x13.5 | 1200 | 0.08 | | | |
| 680 | | 10x10.5 | 500 | 0.11 | 12.5x13.5 | 1200 | 0.08 | 16x16.5 | 1800 | 0.05 | | | |
| 910 | | | | | 12.5x13.5 | 1200 | 0.08 | | | | | | |
| 1000 | | 12.5x13.5 | 1200 | 0.08 | 16x16.5 | 1800 | 0.05 | | | | | | |
| 1500 | | 12.5x13.5 | 1200 | 0.08 | 16x16.5 | 1800 | 0.05 | | | | | | |
| 2200 | | 16x16.5 | 1800 | 0.05 | | | | | | | | | |

SMN Series

- Low impedance, 125°C 3000 hours Long Life
- Applicable to SMT process.
- RoHS Compliance.

Specifications

| Items | Characteristics | | | | |
|------------------------------|---|---|--------------------|---------------------------------|------|
| Capacitance Tolerance | ±20% (120Hz, 20°C) | | | | |
| Operating Temperature Range | -40 ~+125°C | | | | |
| Rated Voltage Range | 16~50VDC | | | | |
| Capacitance Range | 33 ~ 330µF | | | | |
| Leakage Current | $I \leq 0.01CV$ or $3(\mu A)$, which is greater. (After 2 minutes application of DC rated voltage, at 20°C) | | | | |
| Dissipation Factor (tan δ) | Measurement Frequency: 120Hz. Temperature: 20°C | | | | |
| | Rated Voltage(V) | 16 | 25 | 35 | 50 |
| | tan δ(Max) | 0.23 | 0.18 | 0.16 | 0.14 |
| Low Temperature Stability | Measurement Frequency: 120Hz. | | | | |
| | Rated Voltage(V) | 16 | 25 | 35 | 50 |
| | Z (-25°C) /Z(20°C) | 3 | 3 | 2 | 2 |
| Impedance Ratio (Max) | Z (-40°C) /Z(20°C) | | | | |
| | | 4 | 4 | 3 | 3 |
| Load Life | 3000 hours, with application of rated voltage at 125°C | | | | |
| | Capacitance Change | Within ± 30% of Initial Value | | | |
| | tan δ | 300% or less of Initial Specified Value | | | |
| | Leakage Current | Initial Specified Value or less | | | |
| Shelf Life | The following specifications shall be satisfied when the capacitors are restored to 20°C after exposing them for 1,000 hours 105°C without voltage applied. Before the measurement, the capacitor shall be preconditioned by applying voltage according to them 4.1 of JIS C5101-4. | | | | |
| | Capacitance Change | Within ± 30% of Initial Value | | | |
| | tan δ | 300% or less of Initial Specified Value | | | |
| | Leakage Current | Initial Specified Value or less | | | |
| Resistance to Soldering Heat | The capacitors shall be kept on the hot plate maintained at 250°C for 30 seconds. After removing from the hot plate and restored at room temperature they meet the characteristics requirements listed at right. | | Capacitance Change | Within ±10% of Initial Value | |
| | | | tan δ | Initial Specified Value | |
| | | | Leakage Current | Initial Specified Value or less | |
| Standards | JIS C 5101-4-1 (IEC 60384) | | | | |

Frequency Coefficient of Permissible Ripple Current

| Frequency (Hz) | 120 ≤ F < 1K | 1K ≤ F < 10K | 10K ≤ F < 100K | 100K ≤ F |
|------------------|--------------|--------------|----------------|----------|
| Capacitance (µF) | | | | |
| 33~330 | 0.4 | 0.75 | 0.9 | 1.00 |

The endurance of capacitors is reduced with internal heating produced by ripple current at the rate of having the lifetime with every 5°C rise. When long life performance is required in actual use, the rms ripple current has to be reduced.

SMN Series

Chip Type

Dimensions (mm)

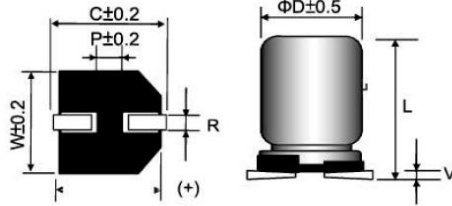

(mm)

| Size | ØD | L | W | H | C | R | P | Vmax |
|-----------|------|----------|------|------|------|---------|-----|------|
| 6.3x6 | 6.3 | 6.0±0.3 | 6.6 | 6.6 | 7.2 | 0.5~0.8 | 2.1 | 0.3 |
| 6.3x7.7 | 6.3 | 7.7±0.3 | 6.6 | 6.6 | 7.2 | 0.5~0.8 | 2.1 | 0.3 |
| 8x10 | 8.0 | 10.0±0.5 | 8.3 | 8.3 | 9.0 | 0.7~1.1 | 3.2 | 0.3 |
| 10x10 | 10.0 | 10.0±0.5 | 10.3 | 10.3 | 11.0 | 0.7~1.1 | 4.5 | 0.3 |
| 12.5x13.5 | 12.5 | 13.5±0.5 | 13.0 | 13.0 | 13.7 | 1.1~1.4 | 4.5 | 0.3 |
| 12.5x16 | 12.5 | 16.5±0.5 | 17.0 | 17.0 | 18.0 | 1.4~1.8 | 6.4 | 0.4 |

Standard Ratings

DxL(mm); R.C. (mA rms) at 125°C 100KHz, ESR(Ω max)

| Cap (µF) | V | 16 | | | | 25 | | | | 35 | | | | 50 | | | |
|----------|---------|-------|------|------|---------|-------|------|-------|---------|-------|-------|------|-------|-------|------|------|-------|
| | | D x L | ESR | | D x L | ESR | | D x L | ESR | | D x L | ESR | | | | | |
| | | | R.C. | 20°C | | -40°C | R.C. | | 20°C | -40°C | | R.C. | 20°C | -40°C | R.C. | 20°C | -40°C |
| 33 | 6.3x6 | 70 | 1.0 | 15 | 6.3x6 | 70 | 1.0 | 15 | | | | | 8x10 | 250 | 0.36 | 4.5 | |
| | | | | | | | | | | | | | | 8x10 | 250 | 0.36 | 4.5 |
| 47 | 6.3x7.7 | 200 | 0.70 | 10 | 6.3x7.7 | 200 | 0.70 | 10 | 8x10 | 300 | 0.30 | 4.5 | 10x10 | 350 | 0.25 | 3 | |
| | | | | | | | | | | | | | | 10x10 | 350 | 0.25 | 3 |
| 100 | 8x10 | 300 | 0.30 | 4.5 | 8x10 | 300 | 0.30 | 4.5 | 10x10 | 500 | 0.20 | 3 | | | | | |
| | | | | | | | | | | | | | | | | | |
| 220 | 10x10 | 500 | 0.20 | 3 | 10x10 | 500 | 0.20 | 3 | | | | | | | | | |
| 330 | 10x10 | 500 | 0.20 | 3 | 10x10 | 500 | 0.20 | 3 | | | | | | | | | |
| 680 | | | | | | | | | 12.5x16 | 1470 | 0.056 | 2 | | | | | |

SMO Series

- Low impedance, 105°C 7000~10000 hours Long life.
- Applicable to SMT process.
- RoHS Compliance.

Specifications

| Items | Characteristics | | | | | | |
|------------------------------|---|---|------|--------------------|---------------------------------|------|------|
| Capacitance Tolerance | ±20 % (120 Hz, 20°C) | | | | | | |
| Operating Temperature Range | -25°C ~ +105°C | | | | | | |
| Rated Voltage Range | 6.3- 50VDC | | | | | | |
| Capacitance Range | 10 ~ 1000μF | | | | | | |
| Leakage Current | I ≤ 0.01CV or 3 (μA), which is greater. (After 2 minutes application of DC rated voltage, at 20°C) | | | | | | |
| Dissipation Factor (tan δ) | Measurement Frequency:120Hz. Temperature: 20°C | | | | | | |
| | Rated Voltage(V) | 6.3 | 10 | 16 | 25 | 35 | 50 |
| | tan δ (Max) | 0.32 | 0.28 | 0.26 | 0.16 | 0.14 | 0.14 |
| Low Temperature Stability | Measurement Frequency: 120Hz. | | | | | | |
| | Rated Voltage(V) | 6.3 | 10 | 16 | 25 | 35 | 50 |
| Impedance Ratio (Max) | Z (-25°C)/ Z (20°C) | 4 | 3 | 2 | 2 | 2 | 2 |
| Load Life | ∅ ≤ 6.3: 7000 hours, ∅ ≥ 8: 10000 with application of rated voltage at 105°C | | | | | | |
| | Capacitance Change | within ±30 % of Initial Value | | | | | |
| | Tan δ | 300% or less of Initial Specified Value | | | | | |
| | Leakage Current | Initial Specified Value or less | | | | | |
| Shelf Life | The following specifications shall be satisfied when the capacitors are restored to 20°C after exposing them for 1000hours 105°C without voltage applied. Before the measurement. The Capacitance shall be preconditioned by applying voltage according to them 4.1 of JIS C5101-4. | | | | | | |
| | Capacitance Change | within ±30 % of Initial Value | | | | | |
| | tan δ | 300% or less of Initial Specified Value | | | | | |
| | Leakage Current | Initial Specified Value or less | | | | | |
| Resistance to Soldering Heat | The capacitors shall be kept on the hot plate maintained at 250°C for 30 seconds. After removing from the hot plate and restored at room temperature they meet the characteristics requirements listed at right. | | | Capacitance Change | Within ±10 of Initial Value | | |
| | | | | tan δ | Initial Specified Value | | |
| | | | | Leakage Current | Initial Specified Value or less | | |
| Standards | JIS C 5101-4-1 (IEC 60384) | | | | | | |

Frequency Coefficient of permissible Ripple Current

| Capacitance (μF) | Frequency (Hz) | | | |
|------------------|----------------|--------------|----------------|----------|
| | 120 ≤ F < 1K | 1K ≤ F < 10K | 10K ≤ F < 100K | 100K ≤ F |
| C ≤ 22 | 0.50 | 0.80 | 0.90 | 1.00 |
| 22 < C ≤ 150 | 0.65 | 0.85 | 0.92 | 1.00 |
| C > 150 | 0.70 | 0.85 | 0.95 | 1.00 |

The endurance of capacitors is reduced with internal heating produced by ripple current at the rate of halving the lifetime with every 5°C rise. When long life performance is required in actual use. The rms ripple current has to be reduced.

DIMENSIONS

▪ **CHIP TYPE**

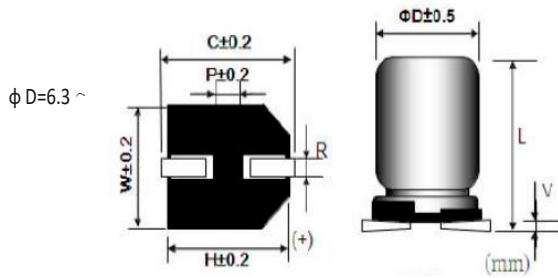

(Unit: mm)

| Size | φD | L | W | H | C | R | P | Vmax |
|---------|------|---------|------|------|------|---------|-----|------|
| 4x7 | 4.0 | 7.0±0.3 | 4.3 | 4.3 | 5.1 | 0.5~0.8 | 1.0 | 0.3 |
| 5x7 | 5.0 | 7.0±0.3 | 5.3 | 5.3 | 5.9 | 0.5~0.8 | 1.4 | 0.3 |
| 6.3x7 | 6.3 | 7.0±0.3 | 6.6 | 6.6 | 7.2 | 0.5~0.8 | 2.1 | 0.3 |
| 6.3x8.4 | 6.3 | 8.4±0.3 | 6.6 | 6.6 | 7.2 | 0.5~0.8 | 2.1 | 0.3 |
| 8x10 | 8.0 | 10±0.5 | 8.3 | 8.3 | 9.0 | 0.7~1.1 | 3.2 | 0.3 |
| 10x10 | 10.0 | 10±0.5 | 10.3 | 10.3 | 11.0 | 0.7~1.3 | 4.5 | 0.3 |

STANDARD RATINGS

DxL(mm) ; R.C.(mA rms) at 105°C 100KHz, IMP(Ω max) at 20°C 100KHz.

| Cap (μF) | V | 6.3 | | | 10 | | | 16 | | | 25 | | | 35 | | | 50 | | |
|-------------|---------|-------|------|---------|-----|------|---------|-------|-------|---------|-----|------|---------|-------|------|-------|-------|------|-----|
| | | D x L | R.C. | IMP | DxL | R.C. | IMP | D x L | R.C. | IMP | DxL | R.C. | IMP | D x L | R.C. | IMP | D x L | R.C. | IMP |
| 10 | | | | | | | 4x7.0 | 27 | 4.00 | | | | 5x7.0 | 95 | 2.20 | | | | |
| | | | | | | | 5x7.0 | 95 | 2.20 | 5x7.0 | 95 | 2.20 | 6.3x8.4 | 100 | 1.80 | | | | |
| 22 | | | | | | | | | | 6.3x7.0 | 140 | 1.10 | 6.3x8.4 | 230 | 1.00 | 8x10 | 350 | 0.53 | |
| 33 | | | | 5x7.0 | 95 | 2.20 | 6.3x7.0 | 140 | 1.10 | 6.3x7.0 | 140 | 1.10 | 6.3x8.4 | 230 | 1.00 | 8x10 | 350 | 0.53 | |
| 47 | 5x7.0 | 95 | 2.20 | | | | 6.3x7.0 | 140 | 1.10 | 6.3x8.4 | 230 | 1.00 | 8x10 | 600 | 0.22 | 10x10 | 670 | 0.35 | |
| 100 | 6.3x7.0 | 140 | 1.10 | | | | 6.3x8.4 | 230 | 1.00 | 8x10 | 600 | 0.22 | | | | | | | |
| 150 | | | | 6.3x7.0 | 140 | 1.10 | 6.3x8.4 | 230 | 1.00 | 8x10 | 600 | 0.22 | 10x10 | 850 | 0.16 | | | | |
| 220 | 6.3x8.4 | 230 | 1.00 | | | | 8x10 | 600 | 0.220 | 10x10 | 850 | 0.16 | 10x10 | 850 | 0.16 | | | | |
| 330 | 6.3x8.4 | 230 | 1.00 | | | | 10x10 | 850 | 0.160 | | | | | | | | | | |
| 470 | 8x10 | 600 | 0.22 | | | | | | | | | | | | | | | | |
| 1000 | 10x10 | 850 | 0.16 | | | | | | | | | | | | | | | | |

SMP Series

- Low impedance, 105°C 2000 hours High CV.
- Applicable to SMT process.
- RoHS Compliance.

Specifications

| Items | Characteristics | | | | | | |
|------------------------------|---|--|------|------|------|--------------------|---------------------------------|
| Capacitance Tolerance | ±20 % (120 Hz, 20°C) | | | | | | |
| Operating Temperature Range | -55°C ~ +105°C | | | | | | |
| Rated Voltage Range | 6.3- 50VDC | | | | | | |
| Capacitance Range | 10 ~ 2200µF | | | | | | |
| Leakage Current | $I \leq 0.01CV$ or 3 (µA), which is greater. (After 2 minutes application of DC rated voltage, at 20°C) | | | | | | |
| Dissipation Factor(tan δ) | Measurement Frequency:120Hz. Temperature: 20°C | | | | | | |
| | Rated Voltage(V) | 6.3 | 10 | 16 | 25 | 35 | 50 |
| | tan δ (Max) | 0.26 | 0.19 | 0.16 | 0.14 | 0.12 | 0.10 |
| Low Temperature Stability | Measurement Frequency: 120Hz. | | | | | | |
| | Rated Voltage(V) | 6.3 | 10 | 16 | 25 | 35 | 50 |
| | Z (-25°C)/Z (20°C) | 4 | 3 | 2 | 2 | 2 | 2 |
| Impedance Ratio (Max) | Z (-40°C)/Z (20°C) | 8 | 5 | 4 | 3 | 3 | 3 |
| | Load Life | 2000 hours, with application of rated voltage at 105°C | | | | | |
| Capacitance Change | | within ±30 % of Initial Value | | | | | |
| tan δ | | 200% or less of Initial Specified Value | | | | | |
| Leakage Current | | Initial Specified Value or less | | | | | |
| Shelf Life | The following specifications shall be satisfied when the capacitors are restored to 20°C after exposing them for 1000hours 105°C without voltage applied. Before the measurement. The Capacitance shall be preconditioned by applying voltage according to them 4.1 of JIS C5101-4. | | | | | | |
| | Capacitance Change | Within ±30 % of Initial Value | | | | | |
| | tan δ | 200% or less of Initial Specified Value | | | | | |
| | Leakage Current | Initial Specified Value or less | | | | | |
| Resistance to Soldering Heat | The capacitors shall be kept on the hot plate maintained at 250°C for 30 seconds. After removing from the hot plate and restored at room temperature they meet the characteristics requirements listed at right. | | | | | Capacitance Change | Within ±10 of Initial Value |
| | | | | | | tan δ | Initial Specified Value |
| | | | | | | Leakage Current | Initial Specified Value or less |
| Standards | JIS C 5101-4-1 (IEC 60384) | | | | | | |

Frequency Coefficient of permissible Ripple Current

| Capacitance (µF) | Frequency (Hz) | | | |
|------------------|-------------------|-------------------|---------------------|---------------|
| | $120 \leq F < 1K$ | $1K \leq F < 10K$ | $10K \leq F < 100K$ | $100K \leq F$ |
| ≤ 470 | 0.65 | 0.85 | 0.95 | 1.00 |
| >470 | 0.70 | 0.90 | 0.95 | 1.00 |

The endurance of capacitors is reduced with internal heating produced by ripple current at the rate of halving the lifetime with every 5°C rise. When long life performance is required in actual use. The rms ripple current has to be reduced.

DIMENSIONS

▪ **CHIP TYPE**

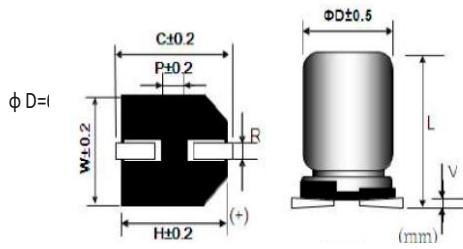

(Unit: mm)

| Size | φD | L | W | H | C | R | P | Vmax |
|---------|------|---------|------|------|------|---------|-----|------|
| 4x6.0 | 4.0 | 6.0±0.3 | 4.3 | 4.3 | 5.1 | 0.5~0.8 | 1.0 | 0.3 |
| 5x6.0 | 5.0 | 6.0±0.3 | 5.3 | 5.3 | 5.9 | 0.5~0.8 | 1.4 | 0.3 |
| 6.3x6.0 | 6.3 | 6.0±0.3 | 6.6 | 6.6 | 7.2 | 0.5~0.8 | 2.1 | 0.3 |
| 6.3x7.7 | 6.3 | 7.7±0.3 | 6.6 | 6.6 | 7.2 | 0.5~0.8 | 2.1 | 0.3 |
| 8x10 | 8.0 | 10±0.5 | 8.3 | 8.3 | 9.0 | 0.7~1.1 | 3.2 | 0.3 |
| 10x10 | 10.0 | 10±0.5 | 10.3 | 10.3 | 11.0 | 0.7~1.3 | 4.5 | 0.3 |

STANDARD RATINGS

DxL(mm); R.C.(mA rms) at 105°C 100KHz, IMP(Ω max) at 20°C 100KHz.

| Cap (μF) | V Item | 6.3 | | | 10 | | | 16 | | | 25 | | | 35 | | | 50 | | |
|-------------|-----------|------|------|-----|---------|------|------|---------|------|------|---------|------|------|---------|------|------|---------|------|------|
| | | DxL | R.C. | IMP | D x L | R.C. | IMP | DxL | R.C. | IMP | DxL | R.C. | IMP | DxL | R.C. | IMP | DxL | R.C. | IMP |
| 10 | | | | | | | | | | | | | | | | | 4x6.0 | 85 | 2.50 |
| | | | | | | | | | | | | | | | | | 5x6.0 | 165 | 0.90 |
| 22 | | | | | | | | | | | 4x6.0 | 160 | 0.95 | 4x6.0 | 160 | 0.95 | 5x6.0 | 165 | 0.90 |
| 33 | | | | | | | | | | | 4x6.0 | 160 | 0.95 | 5x6.0 | 240 | 0.40 | | | |
| 47 | | | | | | | | 4x6.0 | 160 | 0.95 | 5x6.0 | 240 | 0.40 | 5x6.0 | 240 | 0.40 | 6.3x6.0 | 195 | 0.70 |
| 68 | | | | | 4x6.0 | 160 | 0.95 | 5x6.0 | 240 | 0.40 | 5x6.0 | 240 | 0.40 | 6.3x6.0 | 300 | 0.30 | | | |
| 100 | 4x6.0 | 160 | 0.95 | | | | | 5x6.0 | 240 | 0.40 | 6.3x6.0 | 300 | 0.30 | 6.3x6.0 | 300 | 0.30 | 6.3x7.7 | 350 | 0.40 |
| 150 | | | | | 5x6.0 | 240 | 0.40 | 6.3x6.0 | 300 | 0.30 | 6.3x7.7 | 600 | 0.20 | 6.3x7.7 | 600 | 0.20 | | | |
| 220 | 5x6.0 | 240 | 0.40 | | 6.3x6.0 | 300 | 0.30 | 6.3x6.0 | 300 | 0.30 | 6.3x7.7 | 600 | 0.20 | | | | 8x10 | 670 | 0.18 |
| 330 | 6.3x6.0 | 300 | 0.30 | | 6.3x7.7 | 600 | 0.20 | 6.3x7.7 | 600 | 0.20 | | | | 8x10 | 850 | 0.09 | 10x10 | 900 | 0.12 |
| 470 | 6.3x7.7 | 600 | 0.20 | | 6.3x7.7 | 600 | 0.20 | | | | 8x10 | 850 | 0.09 | | | | | | |
| 560 | | | | | | | | | | | | | | 10x10 | 1190 | 0.08 | | | |
| 680 | 6.3x7.7 | 600 | 0.20 | | | | | 8x10 | 850 | 0.09 | | | | | | | | | |
| 820 | | | | | | | | | | | 10x10 | 1190 | 0.08 | | | | | | |
| 1000 | | | | | 8x10 | 850 | 0.09 | 10x10 | 1190 | 0.07 | | | | | | | | | |
| 1500 | 8x10 | 850 | 0.09 | | 10x10 | 1190 | 0.08 | | | | | | | | | | | | |
| 2200 | 10x10 | 1190 | 0.08 | | | | | | | | | | | | | | | | |

SMQ Series

- 135°C 2000 hours Long life.
- Applicable to SMT process.
- RoHS Compliance.

Specifications

| Items | Characteristics | | | | | |
|------------------------------|---|---|------|--------------------|---------------------------------|------|
| Capacitance Tolerance | ±20 % (120 Hz, 20°C) | | | | | |
| Operating Temperature Range | -40°C ~ +135°C | | | | | |
| Rated Voltage Range | 10 - 63VDC | | | | | |
| Capacitance Range | 33 ~ 2200μF | | | | | |
| Leakage Current | 10~63WV 8~10φI ≤ 0.01CV or 3 (μA), 12.5~16φI ≤ 0.03CV or 4 (μA), which is greater. | | | | | |
| Dissipation Factor(tan δ) | Measurement Frequency:120Hz. Temperature: 20°C | | | | | |
| | Rated Voltage(V) | 10 | 16 | 25 | 35~50 | 63 |
| | tan δ (Max) | 0.24 | 0.22 | 0.20 | 0.16 | 0.14 |
| Low Temperature Stability | Measurement Frequency: 120Hz. | | | | | |
| | Rated Voltage(V) | 10 | 16 | 25 | 35~63 | |
| Impedance Ratio (Max) | Z(-25°C)/ Z(20°C) | 4 | 3 | 2 | 2 | |
| | Z(-40°C)/ Z(20°C) | 8 | 6 | 4 | 3 | |
| Load Life | 2000hours, with application of rated voltage at 135°C | | | | | |
| | Capacitance Change | within ±30 % of Initial Value | | | | |
| | Tan δ | 300% or less of Initial Specified Value | | | | |
| | Leakage Current | Initial Specified Value or less | | | | |
| Shelf Life | The following specifications shall be satisfied when the capacitors are restored to 20°C after exposing them for 1000hours 135°C without voltage applied. Before the measurement. The Capacitance shall be preconditioned by applying voltage according to them 4.1 of JIS C5101-4. | | | | | |
| | Capacitance Change | within ±30 % of Initial Value | | | | |
| | Tan δ | 300% or less of Initial Specified Value | | | | |
| | Leakage Current | Initial Specified Value or less | | | | |
| Resistance to Soldering Heat | The capacitors shall be kept on the hot plate maintained at 250°C for 30 seconds. After removing from the hot plate and restored at room temperature they meet the characteristics requirements listed at right. | | | Capacitance Change | Within ±10% of Initial Value | |
| | | | | tan δ | Initial Specified Value | |
| | | | | Leakage Current | Initial Specified Value or less | |
| Standards | JIS C 5101-4-1 (IEC 60384) | | | | | |

Frequency Coefficient of permissible Ripple Current

| Frequency (Hz) | Capacitance (μF) | | | |
|----------------|------------------|--------------|----------------|----------|
| | 100 ≤ F < 1K | 1K ≤ F < 10K | 10K ≤ F < 100K | 100K ≤ F |
| 1~33 | 0.55 | 0.83 | 0.93 | 1.00 |
| >33 | 0.60 | 0.86 | 0.93 | 1.00 |

The endurance of capacitors is reduced with internal heating produced by ripple current at the rate of halving the lifetime with every 5°C rise. When long life performance is required in actual use. The rms ripple current has to be reduced.

SMQ Series

DIMENSIONS

▪ CHIP TYPE

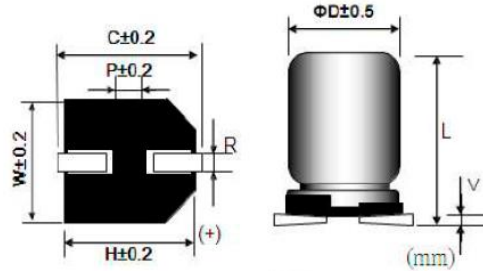

(Unit: mm)

| Size | ØD | L±0.5 | W | H | C | R | P | Vmax |
|-----------|------|----------|------|------|------|---------|-----|------|
| 8x10 | 8.0 | 10.0 | 8.3 | 8.3 | 9.0 | 0.7~1.1 | 3.2 | 0.3 |
| 10x10 | 10.0 | 10.0 | 10.3 | 10.3 | 11.0 | 0.7~1.3 | 4.5 | 0.3 |
| 12.5x13.5 | 12.5 | 13.5 | 13.0 | 13.0 | 13.7 | 1.1~1.4 | 4.5 | 0.4 |
| 16x16.5 | 16.0 | 16.5 | 17.0 | 17.0 | 18.0 | 1.4~1.8 | 6.4 | 0.4 |
| 16x21.5 | 16.0 | 21.5 | 17.0 | 17.0 | 18.0 | 1.4~1.8 | 6.4 | 0.4 |
| 15x16.5 | 18.0 | 16.5±1.0 | 19.0 | 19.0 | 20.0 | 1.4~1.8 | 6.4 | 0.4 |
| 18x21.5 | 18.0 | 21.5±1.0 | 19.0 | 19.0 | 20.0 | 1.4~1.8 | 6.4 | 0.4 |

STANDARD RATINGS

D×L(mm) ; R.C.(mA rms) at 135°C 100KHz, IMP(Ω max) at 20°C 100KHz.

| Cap(µF) V | 10 | | 16 | | 25 | | 35 | | 50 | | 63 | |
|-------------|-----------|------|-----------|------|-----------|------|-----------|------|-----------|------|---------|------|
| Item | D x L | R.C. | DxL | R.C. | DxL | R.C. | DxL | R.C. | D x L | R.C. | D x L | R.C. |
| 33 | | | | | | | | | | | 8x10 | 100 |
| 47 | | | | | | | | | 8x10 | 160 | 10x10 | 120 |
| 100 | | | 8x10 | 220 | 8x10 | 220 | 8x10 | 200 | 10x10 | 240 | 10x10 | 270 |
| 220 | 8x10 | 220 | 8x10 | 220 | 10x10 | 216 | 10x10 | 300 | 12.5x13.5 | 550 | | |
| 330 | 8x10 | 220 | | | | | 12.5x13.5 | 750 | | | | |
| | 10x10 | 300 | 10x10 | 300 | 10x10 | 300 | | | | | | |
| 470 | 10x10 | 300 | 10x10 | 280 | 12.5x13.5 | 750 | | | 16x16.5 | 850 | 16x16.5 | 820 |
| 680 | | | 12.5x13.5 | 280 | | | 16x16.5 | 1000 | 15x16.5 | 1200 | | |
| 1000 | 12.5x13.5 | 750 | | | 16x16.5 | 1000 | 16x16.5 | 1000 | 16x21.5 | 1600 | | |
| 1500 | 12.5x13.5 | 750 | 16x16.5 | 1000 | 16x16.5 | 1000 | 16x21.5 | 1900 | | | | |
| 2200 | 16x16.5 | 1000 | | | 15x16.5 | 1400 | 16x21.5 | 2200 | | | | |
| 2700 | 16x16.5 | 1000 | | | 16x21.5 | 1900 | | | | | | |
| 3300 | | | | | 15x21.5 | 2200 | | | | | | |

STA Series

- 85°C 3000hours, Screw terminal type.
- High ripple current resistance.
- Suitable for industrial machinery, power converter, communication sets and test equipment.
- RoHS Compliant & Halogen Free

Specifications

| Items | Characteristics | | | | | | | | | | | |
|-----------------------------|---|---|-----|------|------|--------------|-----------|------|---------|---------|------|------|
| Capacitance Tolerance | ± 20% (120Hz, 20°C) | | | | | | | | | | | |
| Operating Temperature Range | -40 ~ +85°C | | | | | -25 ~ +85°C | | | | | | |
| Rated Voltage Range | 16 ~ | | | | | 350 ~ 500VDC | | | | | | |
| Rated Capacitance Range | 220 ~ 1,000,000μF | | | | | | | | | | | |
| Leakage Current | I ≤ 0.02CV (μA) or 5mA, which is greater. (After 5 minutes application of DC rated voltage, at 20°C) | | | | | | | | | | | |
| Dissipation Factor | Measurement Frequency: 120Hz. Temperature: 20°C | | | | | | | | | | | |
| | Rated Voltage (V) | 16 | 25 | 35 | 50 | 63 | 80 | 100 | 160~250 | 350~450 | 600 | |
| | tan δ (Max) | 35∅ | 0.7 | 0.45 | 0.40 | 0.30 | 0.25 | 0.25 | 0.20 | 0.20 | 0.25 | 0.25 |
| | | 51∅ | 0.9 | 0.60 | 0.60 | 0.45 | 0.35 | 0.30 | 0.20 | 0.20 | 0.25 | 0.25 |
| | | 64∅ | 1.3 | 0.90 | 0.80 | 0.50 | 0.40 | 0.35 | 0.25 | 0.20 | 0.25 | 0.25 |
| | | 76∅ | 2.0 | 1.20 | 0.90 | 0.70 | 0.50 | 0.40 | 0.35 | 0.25 | 0.25 | 0.25 |
| 90∅ | | - | - | - | - | - | - | - | - | 0.25 | 0.25 | 0.25 |
| Low Temperature Stability | Measurement Frequency: 120Hz. | | | | | | | | | | | |
| | Rated Voltage(V) | 16 ~ 250 | | | | | 350 ~ 500 | | | | | |
| | Z(-25°C)/Z(20°C) | - | | | | | 8 | | | | | |
| Impedance Ratio (Max) | Z(-40°C)/Z(20°C) | 12 | | | | | - | | | | | |
| | 3,000 hours, with application of rated voltage at 85°C | | | | | | | | | | | |
| Load Life | Capacitance Change | Within ± 15% of Initial Value | | | | | | | | | | |
| | tan δ | 175% or less of Initial Specified Value | | | | | | | | | | |
| | Leakage Current | Initial Specified Value or less | | | | | | | | | | |
| | The following specifications shall be satisfied when the capacitors are restored to 20°C after exposing them for 1,000 hours 85°C without voltage applied. Before the measurement the capacitor shall be preconditioned by applying voltage according to them 4.1 of JIS C5101-4. | | | | | | | | | | | |
| Shelf Life | Capacitance Change | Within ± 15% of Initial Value | | | | | | | | | | |
| | tan δ | 175% or less of Initial Specified Value | | | | | | | | | | |
| | Leakage Current | Initial Specified Value or less | | | | | | | | | | |
| | Standards | | | | | | | | | | | |
| JIS C-5101-4(IEC 60384) | | | | | | | | | | | | |

Frequency Coefficient of Permissible Ripple Current

| Rated Voltage (V) | Frequency (Hz) | | | |
|-------------------|----------------|------|------|-------|
| | 50 | 120 | 1K | ≥ 10K |
| 16 ~ 100 | 0.90 | 1.00 | 1.15 | 1.15 |
| 160 ~ 250 | 0.88 | 1.00 | 1.15 | 1.20 |
| 350 ~ 500 | 0.82 | 1.00 | 1.30 | 1.40 |

The endurance of capacitors is reduced with internal heating produced by ripple current at the rate of halving the lifetime with every 5°C rise. When long life performance is required in actual use, the RMS ripple current has to be reduced.

STA Series

Dimensions (mm)

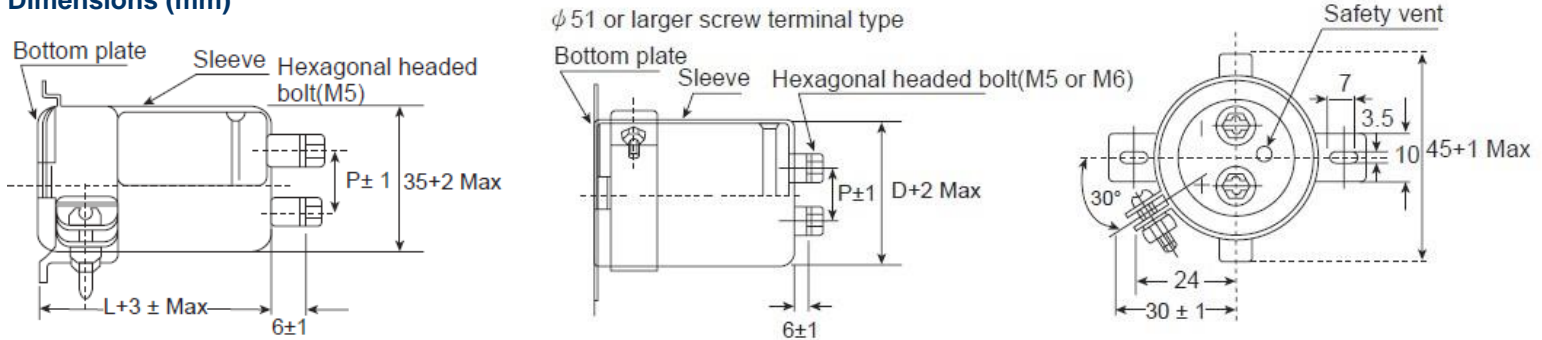

Terminal Pitch (W) & LENGTH (e) TABLE

| ØD | W |
|----|------|
| 35 | 12.7 |
| 51 | 22.0 |
| 64 | 28.6 |
| 76 | 31.8 |
| 90 | 31.8 |

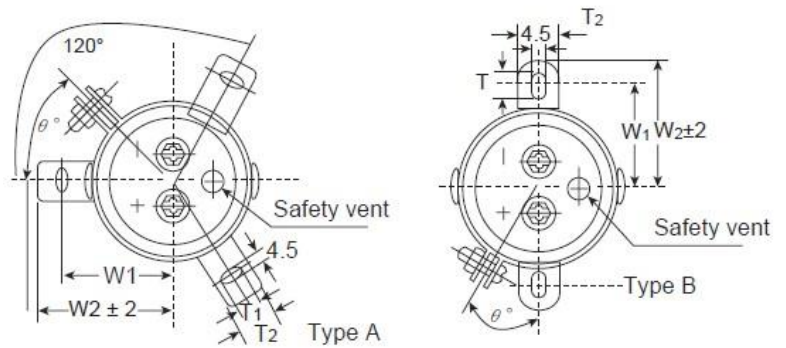

Dimensions of Mounting Bracket (mm)

| Cap (µF) | Leg Shape | 3-Legs | | | | 2-Legs | | | | |
|----------|----------------|--------|------|-----|------|--------|------|------|------|-----|
| | | ØD | Ø51 | Ø64 | Ø76 | Ø90 | Ø51 | Ø64 | Ø76 | Ø90 |
| | W ₁ | | 32.5 | 38 | 44.5 | 50.8 | 33.2 | 40.5 | 46.5 | 53 |
| | W ₂ | | 38 | 43 | 49.2 | 57 | 39.5 | 46.5 | 53 | 59 |
| | T ₁ | | 7 | 8 | 7 | 7 | 6 | 6 | 6 | 6 |
| | T ₂ | | 12 | 14 | 16 | 16 | 14 | 14 | 14 | 14 |
| | θ° | | 60 | 60 | 60 | 60 | 30 | 30 | 30 | 30 |

Standard Ratings

DxL(mm);R.C.(A rms) at 85°C 120Hz.

| Cap (µF) | V | 16 | | 25 | | 35 | | 50 | | 63 | |
|----------|---|--------|-------|--------|-------|--------|-------|--------|-------|--------|-------|
| | | Item | D x L | R.C. | D x L | R.C. | D x L | R.C. | D x L | R.C. | D x L |
| 10000 | | | | | | | | | | 35x80 | 4.0 |
| 15000 | | | | | | | | 35x80 | 5.4 | 35x100 | 5.5 |
| 22000 | | | | | | | | 35x100 | 6.0 | 35x120 | 7.0 |
| 33000 | | | | 35x80 | 6.0 | 35x80 | 6.2 | 51x80 | 7.0 | 51x80 | 8.8 |
| 47000 | | 35x80 | 6.4 | 35x100 | 8.2 | 35x120 | 8.2 | 51x100 | 8.6 | 51x120 | 11.7 |
| 68000 | | 35x100 | 7.9 | 35x120 | 9.4 | 51x80 | 9.3 | 51x100 | 11.0 | 64x100 | 15.0 |
| 100000 | | 35x120 | 10.6 | 51x100 | 12.0 | 51x120 | 13.6 | 64x100 | 14.2 | 64x140 | 20.8 |
| 150000 | | 51x120 | 11.5 | 51x120 | 15.3 | 64x120 | 16.5 | 76x120 | 18.6 | 76x140 | 26.0 |
| 220000 | | 51x120 | 15.6 | 64x120 | 18.9 | 76x100 | 20.1 | | | | |
| 330000 | | 64x120 | 25.0 | 76x120 | 23.2 | 76x150 | 24.8 | | | | |
| 470000 | | 76x120 | 30.5 | | | | | | | | |
| 500000 | | 76x160 | 32.0 | | | | | | | | |

STA Series

Standard Ratings

DxL(mm);R.C.(A rms) at 85°C 120Hz.

| Cap (µF) | V | 80 | | 100 | | 160 | | 200 | | 250 | |
|----------|------|--------|------|--------|------|--------|------|--------|------|--------|------|
| | Item | D x L | R.C. | D x L | R.C. | D x L | R.C. | D x L | R.C. | D x L | R.C. |
| 1000 | | | | | | | | | | 35x80 | 2.4 |
| 1500 | | | | | | | | 35x80 | 2.9 | 35x100 | 3.0 |
| 2200 | | | | | | 35x80 | 3.2 | 35x100 | 3.5 | 51x80 | 4.0 |
| 3300 | | | | | | 35x120 | 4.7 | 51x80 | 4.8 | 51x100 | 5.4 |
| 4700 | | | | 35x80 | 3.7 | 51x80 | 5.0 | 51x100 | 6.3 | 64x100 | 7.3 |
| 6800 | | | | 35x100 | 4.5 | 51x100 | 6.4 | 51x140 | 7.3 | 64x120 | 8.9 |
| 10000 | | 35x80 | 4.2 | 35x120 | 5.3 | 64x100 | 9.0 | 64x120 | 9.8 | 76x120 | 11.8 |
| 15000 | | 35x120 | 6.0 | 51x80 | 6.0 | 76x100 | 12.0 | 76x120 | 13.0 | 90x150 | 16.4 |
| 22000 | | 51x80 | 6.5 | 51x100 | 6.8 | 76x140 | 16.9 | 90x150 | 15.9 | | |
| 33000 | | 51x120 | 9.2 | 51x140 | 10.0 | 90x150 | 19.2 | | | | |
| 47000 | | 64x120 | 12.7 | 64x140 | 14.1 | | | | | | |
| 68000 | | 64x140 | 15.5 | 76x150 | 18.2 | | | | | | |
| 100000 | | 76x150 | 21.3 | | | | | | | | |

| Cap (µF) | V | 350 | | 400 | | 450 | | 500 | |
|----------|------|--------|------|--------|------|--------|------|--------|------|
| | Item | D x L | R.C. | D x L | R.C. | D x L | R.C. | D x L | R.C. |
| 470 | | | | 35x80 | 2.0 | 35x80 | 2.0 | 51x75 | 2.2 |
| 680 | | 35x80 | 2.5 | 35x100 | 2.6 | 35x120 | 2.9 | 51x100 | 3.1 |
| 1000 | | 51x60 | 3.3 | 51x80 | 3.3 | 51x80 | 3.6 | 51x130 | 3.8 |
| 1200 | | 51x80 | 3.6 | 51x80 | 4.2 | 51x100 | 4.2 | 64x100 | 4.6 |
| 1500 | | 51x80 | 4.5 | 51x100 | 4.8 | 51x120 | 5.0 | 64x120 | 5.4 |
| 1800 | | 51x100 | 5.1 | 51x120 | 5.4 | 64x100 | 5.4 | 64x130 | 5.8 |
| 2200 | | 51x120 | 6.0 | 51x140 | 6.3 | 64x120 | 6.6 | 76x120 | 6.9 |
| 2700 | | 51x140 | 6.9 | 64x120 | 7.2 | 64x140 | 7.5 | 76x150 | 7.9 |
| 3300 | | 64x100 | 8.0 | 64x140 | 8.4 | 76x120 | 8.4 | 90x140 | 8.6 |
| 3900 | | 64x120 | 9.0 | 76x100 | 8.7 | 76x150 | 9.6 | 90x150 | 10.0 |
| 4700 | | 76x100 | 9.6 | 76x150 | 10.5 | 76x150 | 11.4 | 90x190 | 12.0 |
| 5600 | | 76x120 | 11.4 | 76x150 | 12.3 | 76x150 | 13.2 | | |
| 6800 | | 76x150 | 13.5 | 76x150 | 13.5 | 90x150 | 14.4 | | |
| 8200 | | 76x150 | 15.0 | 90x150 | 15.9 | 90x150 | 15.9 | | |
| 10000 | | 90x150 | 16.8 | 90x150 | 17.7 | 90x190 | 17.5 | | |
| 12000 | | 90x150 | 18.4 | 90x190 | 20.7 | | | | |
| 15000 | | 90x190 | 22.8 | | | | | | |

STB Series

- 105°C 5000hours, Screw terminal type
- High temperature, high ripple current resistance and long life.
- RoHS Compliant & Halogen Free

Specifications

| Items | Characteristics | | | | | | | | | | | | | |
|---|--|---------|---|------|------|------|--------------|------|-----------|------|---------|---------|------|--|
| Capacitance Tolerance | ± 20% (120Hz, 20°C) | | | | | | | | | | | | | |
| Operating Temperature Range | -40 ~ +105°C | | | | | | -25 ~ +105°C | | | | | | | |
| Rated Voltage Range | 10 ~ 100VDC | | | | | | 160 ~ 450VDC | | | | | | | |
| Rated Capacitance Range | 220 ~ 1,000,000μF | | | | | | | | | | | | | |
| Leakage Current | I ≤ 0.02CV (μA) or 5mA, which is greater. (After 5 minutes application of DC rated voltage, at 20°C) | | | | | | | | | | | | | |
| Dissipation Factor | Measurement Frequency: 120Hz. Temperature: 20°C | | | | | | | | | | | | | |
| | Rated Voltage (V) | | 10 | 16 | 25 | 35 | 50 | 63 | 80 | 100 | 160~250 | 350~450 | | |
| | tan δ (Max) | 35∅ | 80~140 | 0.65 | 0.45 | 0.40 | 0.30 | 0.25 | 0.25 | 0.20 | 0.12 | 0.15 | 0.20 | |
| | | 51∅ | 80~140 | 0.90 | 0.60 | 0.50 | 0.40 | 0.25 | 0.25 | 0.20 | 0.15 | 0.15 | 0.20 | |
| | | 64∅ | 120~190 | 1.20 | 0.80 | 0.70 | 0.50 | 0.35 | 0.30 | 0.25 | 0.20 | 0.20 | 0.20 | |
| | | 76∅ | 120~190 | 2.00 | 1.20 | 0.90 | 0.70 | 0.55 | 0.50 | 0.35 | 0.30 | 0.20 | 0.20 | |
| 90∅ | | 150~190 | 2.40 | 2.00 | 1.50 | 1.00 | 0.75 | 0.60 | 0.40 | 0.30 | 0.25 | 0.20 | | |
| 100∅ | 220 | 2.00 | 2.00 | 1.50 | 1.00 | 0.75 | 0.60 | 0.40 | 0.30 | 0.25 | 0.20 | | | |
| Low Temperature Stability Impedance Ratio (Max) | Measurement Frequency: 120Hz. | | | | | | | | | | | | | |
| | Rated Voltage(V) | | 10 ~ 100 | | | | | | 160 ~ 450 | | | | | |
| | Z(-25°C) / Z(20°C) | | - | | | | | | 8 | | | | | |
| | Z(-40°C) / Z(20°C) | | 12 | | | | | | - | | | | | |
| Load Life | 5,000 hours, (10 ~ 250 V, 2,000 hours), with application of rated voltage at 105°C | | | | | | | | | | | | | |
| | Capacitance Change | | Within ± 20% of Initial Value | | | | | | | | | | | |
| | tan δ | | 300% or less of Initial Specified Value | | | | | | | | | | | |
| | Leakage Current | | Initial Specified Value or less | | | | | | | | | | | |
| Shelf Life | The following specifications shall be satisfied when the capacitors are restored to 20°C after exposing them for 1,000 hours 105°C without voltage applied. Before the measurement the capacitor shall be preconditioned by applying voltage according to them 4.1 of JIS C5101-4. | | | | | | | | | | | | | |
| | Capacitance Change | | Within ± 20% of Initial Value | | | | | | | | | | | |
| | tan δ | | 300% or less of Initial Specified Value | | | | | | | | | | | |
| | Leakage Current | | Initial Specified Value or less | | | | | | | | | | | |
| Standards | JIS C-5101-4(IEC 60384) | | | | | | | | | | | | | |

Frequency Coefficient for Ripple Current

| Rated Voltage (V) | Frequency (Hz) | | | | |
|-------------------|----------------|------|------|------|-------|
| | 60 | 120 | 360 | 1K | ≥ 10K |
| 10 ~ 100 | 0.90 | 1.00 | 1.08 | 1.15 | 1.15 |
| 160 ~ 250 | 0.88 | 1.00 | 1.08 | 1.15 | 1.20 |
| 350 ~ 450 | 0.82 | 1.00 | 1.20 | 1.35 | 1.40 |

The endurance of capacitors is reduced with internal heating produced by ripple current at the rate of halving the lifetime with every 5°C rise. When long life performance is required in actual use, the RMS ripple current has to be reduced.

STB Series

Dimensions (mm)

Screw terminal type for $\phi 51$ and larger

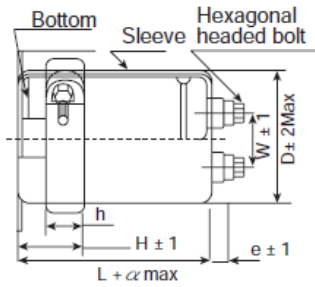

3-leg brackets for $\phi 90$ capacitors have different hole shapes from the ordinary ones as illustrated below.

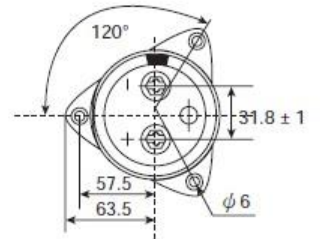
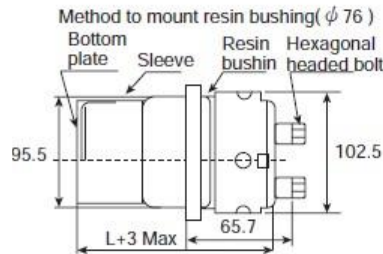
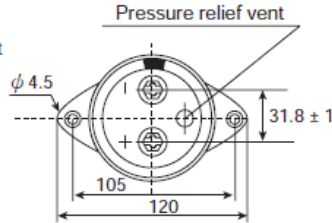
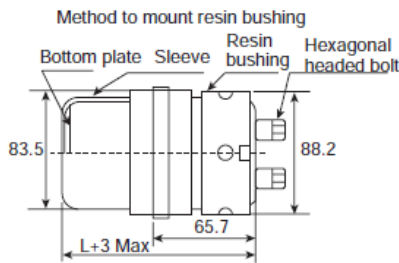
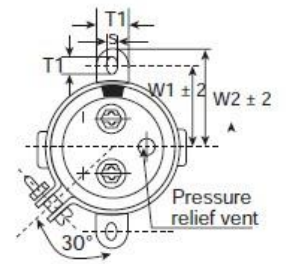
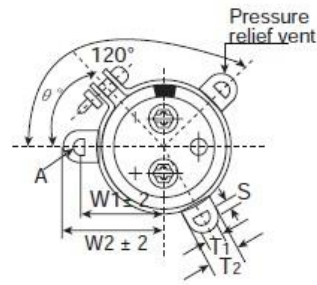
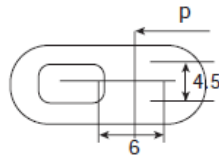

Terminal Pitch (W) & LENGTH (e) TABLE

| ϕD | W | e | α |
|----------|------|----|----------|
| 35 | 12.7 | 1 | 3 |
| 51 | 22.0 | 6 | 3 |
| 64 | 28.6 | 6 | 3 |
| 76 | 31.8 | 6 | 3 |
| 90 | 31.8 | 6 | 3 |
| 100 | 41.5 | 10 | 4 |

Dimensions of Mounting Bracket (mm)

| Cap (μF) | Leg Shape | 3-Legs | | | | | 2-Legs | | | |
|-----------------|----------------|-----------|-----------|-----------|-----------|------------|-----------|-----------|-----------|-----------|
| | | $\phi 51$ | $\phi 64$ | $\phi 76$ | $\phi 90$ | $\phi 100$ | $\phi 51$ | $\phi 64$ | $\phi 76$ | $\phi 90$ |
| | W_1 | 32.5 | 38 | 44.5 | 50.8 | 56.3 | 33.2 | 40.5 | 46.5 | 53 |
| | W_2 | 38.5 | 43 | 49.2 | 57 | 62 | 40 | 46.5 | 53 | 59 |
| | T_1 | 7.5 | 8 | 7 | 7 | 8 | 6 | 6 | 6 | 6 |
| | T_2 | 12 | 14 | 14 | 16 | 16 | 14 | 14 | 14 | 14 |
| | S | 5 | 5 | 5 | 5 | 5 | 4.5 | 4.5 | 4.5 | 4.5 |
| | θ° | 60 | 60 | 60 | 60 | 60 | 30 | 30 | 30 | 30 |
| | H | 20 | 25 | 30 | 35 | 36 | 25 | 35 | 35 | 35 |
| | h | 15 | 20 | 24 | 20 | 30 | 15 | 20 | 20 | 20 |

Standard Ratings

DxL(mm);R.C.(A rms) at 105°C 120Hz.

| Cap (µF) | V | 10 | | 16 | | 25 | | 35 | |
|----------|------|--------|------|--------|------|--------|------|--------|------|
| | Item | D x L | R.C. | D x L | R.C. | D x L | R.C. | D x L | R.C. |
| 10000 | | | | | | | | 35x100 | 4.3 |
| 15000 | | | | | | | | 35x100 | 5.0 |
| 22000 | | | | | | 35x100 | 4.4 | 35x120 | 5.2 |
| 33000 | | 35x80 | 4.7 | 35x80 | 4.8 | 35x120 | 6.0 | 35x140 | 7.0 |
| 47000 | | 35x100 | 6.0 | 35x100 | 6.0 | 51x100 | 8.0 | 51x120 | 8.0 |
| 68000 | | 51x80 | 6.5 | 51x80 | 6.5 | 51x140 | 10.0 | 51x140 | 12.0 |
| 100000 | | 51x100 | 8.2 | 51x100 | 9.0 | 64x120 | 11.0 | 64x140 | 13.2 |
| 150000 | | 51x120 | 10.2 | 51x120 | 11.4 | 64x140 | 13.5 | 76x150 | 15.0 |
| 220000 | | 64x120 | 13.0 | 64x120 | 14.5 | 76x150 | 16.5 | 90x150 | 17.1 |
| 330000 | | 76x120 | 15.2 | 76x120 | 17.0 | 90x150 | 20.2 | 90x190 | 21.0 |
| 470000 | | 90x140 | 16.0 | 90x140 | 20.2 | 90x190 | 22.0 | | |
| 680000 | | 90x170 | 18.0 | 90x170 | 22.0 | | | | |
| 1000000 | | 90x180 | 20.0 | 90x190 | 23.5 | | | | |

Standard Ratings

DxL(mm);R.C.(A rms) at 105°C 120Hz.

| Cap (µF) | V | 50 | | 63 | | 80 | | 100 | |
|----------|------|---------|------|---------|------|---------|------|---------|------|
| | Item | D x L | R.C. | D x L | R.C. | D x L | R.C. | D x L | R.C. |
| 2200 | | | | | | | | 35x100 | 2.0 |
| 3300 | | | | | | | | 35x100 | 3.0 |
| 4700 | | | | | | 35x100 | 3.1 | 35x120 | 3.4 |
| 6800 | | | | | | 35x120 | 3.4 | 51x100 | 5.0 |
| 10000 | | 35x100 | 4.5 | 35x120 | 4.5 | 51x100 | 5.0 | 51x120 | 6.2 |
| 15000 | | 35x120 | 5.2 | 51x100 | 5.5 | 51x120 | 6.0 | 64x120 | 7.4 |
| 22000 | | 51x100 | 6.0 | 51x120 | 6.5 | 64x120 | 8.0 | 76x120 | 9.5 |
| 33000 | | 51x140 | 7.5 | 64x120 | 9.0 | 76x120 | 9.5 | 76x150 | 12.3 |
| 47000 | | 64x120 | 9.5 | 64x140 | 11.0 | 76x150 | 13.0 | 90x150 | 16.5 |
| 68000 | | 64x140 | 12.5 | 76x150 | 13.2 | 90x150 | 16.5 | 90x190 | 18.0 |
| 100000 | | 76x150 | 16.5 | 90x150 | 17.3 | 90x190 | 18.2 | 100x220 | 20.2 |
| 150000 | | 90x150 | 19.5 | 90x190 | 20.5 | 100x220 | 21.2 | | |
| 220000 | | 90x190 | 21.5 | 100x220 | 23.2 | | | | |
| 330000 | | 100x220 | 24.0 | | | | | | |

| Cap (µF) | V | 160 | | 200 | | 250 | |
|----------|------|--------|------|--------|------|--------|------|
| | Item | D x L | R.C. | D x L | R.C. | D x L | R.C. |
| 680 | | | | | | 35x100 | 1.4 |
| 1000 | | 35x100 | 1.6 | 35x100 | 1.7 | 35x120 | 1.9 |
| 1500 | | 35x100 | 2.1 | 35x120 | 2.3 | 51x100 | 2.4 |
| 2200 | | 35x120 | 2.7 | 51x100 | 2.9 | 51x120 | 3.2 |
| 3300 | | 51x100 | 3.8 | 51x120 | 3.9 | 64x120 | 4.3 |
| 4700 | | 51x120 | 4.5 | 64x120 | 5.1 | 64x140 | 5.9 |
| 6800 | | 64x120 | 6.8 | 64x140 | 7.0 | 76x150 | 7.1 |
| 10000 | | 64x150 | 7.8 | 76x150 | 8.2 | 90x150 | 9.6 |
| 15000 | | 76x150 | 9.8 | 76x150 | 10.4 | 90x190 | 12.7 |
| 22000 | | 76x150 | 12.5 | 90x150 | 15.1 | | |
| 33000 | | 90x150 | 13.4 | | | | |

| Cap (µF) | V | 350 | | 400 | | 450 | |
|----------|------|--------|------|--------|------|--------|------|
| | Item | D x L | R.C. | D x L | R.C. | D x L | R.C. |
| 220 | | | | 35x100 | 1.2 | 35x100 | 1.4 |
| 330 | | 35x100 | 2.0 | 35x100 | 2.0 | 35x120 | 2.0 |
| 470 | | 35x100 | 2.4 | 35x120 | 3.0 | 51x100 | 3.0 |
| 680 | | 51x100 | 4.0 | 51x100 | 4.0 | 51x120 | 4.0 |
| 1000 | | 51x100 | 6.2 | 51x100 | 6.2 | 51x120 | 6.5 |
| 1500 | | 51x120 | 8.2 | 51x140 | 9.0 | 51x140 | 9.0 |
| 2200 | | 51x140 | 10.6 | 64x120 | 11.2 | 64x120 | 11.4 |
| 2700 | | 64x120 | 12.2 | 64x120 | 13.0 | 64x140 | 13.4 |
| | | | | | | 76x120 | 14.1 |
| 3300 | | 64x120 | 14.0 | 64x140 | 15.0 | 64x170 | 16.2 |
| | | | | | | 76x150 | 17.0 |
| 3900 | | 64x140 | 16.4 | 64x170 | 17.5 | 64x190 | 18.0 |
| | | | | 76x120 | 18.0 | | |
| 4700 | | 64x140 | 19.4 | 64x190 | 20.3 | 76x170 | 21.3 |
| | | 76x150 | 19.3 | 76x150 | 20.0 | | |
| 5600 | | 76x150 | 22.0 | 76x170 | 23.3 | 76x190 | 26.0 |
| | | | | | | 90x170 | 24.0 |
| 6800 | | 76x170 | 26.0 | 76x190 | 27.2 | 90x190 | 28.0 |
| | | | | 90x170 | 26.5 | | |
| 8200 | | 76x170 | 30.0 | 90x190 | 29.5 | | |
| | | 90x150 | 29.0 | | | | |
| 10000 | | 90x170 | 32.0 | | | | |

STC Series

- Load life: 85°C 5000Hours Screw terminal type.
- Suitable for use in industrial equipment industrial power,
- Used in solar pv inverter, wind power, Marine, heavy trucks, and other fields.
- RoHS Compliant & Halogen Free

Specifications

| Items | Characteristics | | | | | |
|-----------------------------|--|---|------|------|------|------|
| Capacitance Tolerance | ± 20% (120Hz, 20°C) | | | | | |
| Operating Temperature Range | -25 ~ +85°C | | | | | |
| Rated Voltage Range | 350 ~ 500VDC | | | | | |
| Rated Capacitance Range | 220 ~ 1,000,000μF | | | | | |
| Leakage Current | I ≤ 0.02CV (μA) or 5mA, which is greater. (After 5 minutes application of DC rated voltage, at 20°C) | | | | | |
| Dissipation Factor | Measurement Frequency: 120Hz. Temperature: 20°C | | | | | |
| | Rated Voltage (V) | 160 | 350 | 400 | 450 | 500 |
| | tan δ (Max) | 0.20 | 0.15 | 0.15 | 0.15 | 0.15 |
| Temperature Stability | Measurement Frequency: 120Hz. | | | | | |
| | Capacitance Change C (-25°C) / Z(20°C) ≥ 0.6 | | | | | |
| Load Life | 5000 hours, with application of rated voltage at 85°C | | | | | |
| | Capacitance Change | Within ± 20% of Initial Value | | | | |
| | tan δ | 200% or less of Initial Specified Value | | | | |
| | Leakage Current | Initial Specified Value or less | | | | |
| Shelf Life | The following specifications shall be satisfied when the capacitors are restored to 20°C after exposing them for 500 hours 85°C without voltage applied. Before the measurement, the capacitor shall be preconditioned by applying voltage according to them 4.1 of JIS C5101-4. | | | | | |
| | Capacitance Change | Within ± 20% of Initial Value | | | | |
| | tan δ | 200% or less of Initial Specified Value | | | | |
| | Leakage Current | Initial Specified Value or less | | | | |
| Standards | JIS C 5101-4-1 (IEC 60384) | | | | | |

Frequency Coefficient for Ripple Current

| Rated Voltage (V) | Frequency (Hz) | | | | |
|-------------------|----------------|------|------|------|-------|
| | 50 | 120 | 300 | 1K | ≥ 10K |
| 350 ~ 500 | 0.80 | 1.00 | 1.20 | 1.30 | 1.40 |

The endurance of capacitors is reduced with internal heating produced by ripple current at the rate of halving the lifetime with every 5°C rise. When long life performance is required in actual use, the RMS ripple current has to be reduced.

STC Series

Dimensions (mm)

Screw terminal type for $\phi 51$ and larger

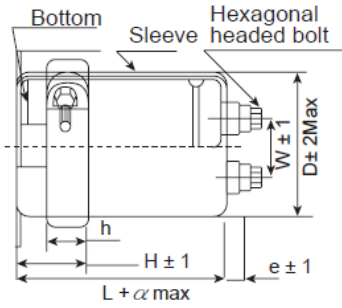

3-leg brackets for $\phi 90$ capacitors have different hote shapes from the ordinary ones as illustrated below.

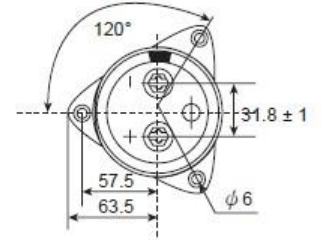
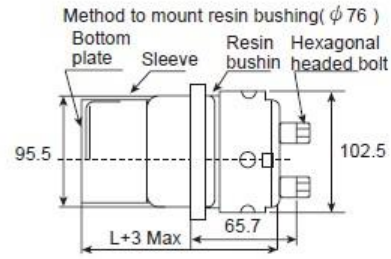
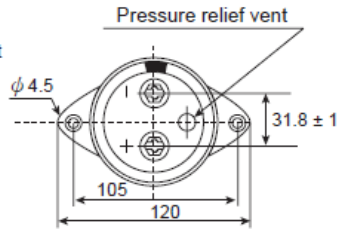
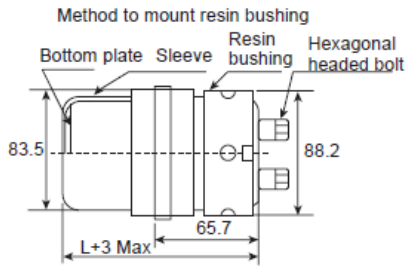
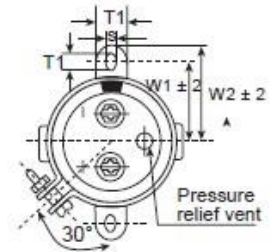
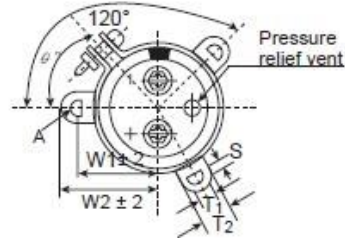
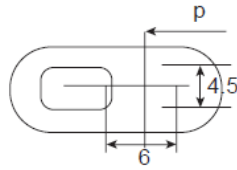

Terminal Pitch (W) & LENGTH (e) TABLE

| ϕD | W | e | α |
|----------|------|----|----------|
| 51 | 22 | 6 | 3 |
| 64 | 28.6 | 6 | 3 |
| 76 | 31.8 | 6 | 3 |
| 90 | 31.8 | 6 | 3 |
| 100 | 41.5 | 10 | 4 |

Dimensions of Mounting Bracket (mm)

| Cap (μF) | Leg Shape ϕD | 3-Legs | | | | | $\phi 100$ | 2-Legs | | | |
|-----------------|-----------------------|-----------|-----------|-----------|-----------|-----------|------------|-----------|-----------|-----------|--|
| | | $\phi 51$ | $\phi 64$ | $\phi 76$ | $\phi 90$ | $\phi 51$ | | $\phi 64$ | $\phi 76$ | $\phi 90$ | |
| | W1 | 32.5 | 38 | 44.5 | 50.8 | 56.3 | 33.2 | 40.5 | 46.5 | 53 | |
| | W2 | 38.5 | 43 | 49.2 | 57 | 62 | 40 | 46.5 | 53 | 59 | |
| | T1 | 7.5 | 8.0 | 7.0 | 7.0 | 8.0 | 6.0 | 6.0 | 6.0 | 6.0 | |
| | T2 | 12 | 14 | 14 | 16 | 16 | 14 | 14 | 14 | 14 | |
| | S | 5.0 | 5.0 | 5.0 | 5.0 | 5.0 | 4.5 | 4.5 | 4.5 | 4.5 | |
| | θ° | 60 | 60 | 60 | 60 | 60 | 30 | 30 | 30 | 30 | |
| | H | 20 | 25 | 30 | 35 | 36 | 25 | 35 | 35 | 35 | |
| | h | 15 | 20 | 24 | 20 | 30 | 15 | 20 | 20 | 20 | |

Standard Ratings

DxL(mm);R.C.(A rms) at 85°C 120Hz.

| Cap (µF) | V Item | 350 | | 400 | | 450 | | 500 | |
|----------|--------|--------|------|--------|------|--------|------|--------|------|
| | | D x L | R.C. | D x L | R.C. | D x L | R.C. | D x L | R.C. |
| 1500 | | | | | | | | 64x115 | 8.6 |
| 1800 | | | | | | 64x95 | 6.7 | 64x130 | 10.0 |
| 2200 | | | | | | 64x100 | 10.4 | 64x155 | 11.7 |
| | | | | | | 76x95 | 11.5 | | |
| 2700 | | | | 64x100 | 11.5 | 64x130 | 12.8 | 76x120 | 15 |
| 3300 | | | | 64x130 | 14.2 | 64x155 | 15.2 | 76x145 | 17.5 |
| | | | | | | 76x120 | 15.8 | | |
| 3900 | | 64x115 | 14.6 | 64x155 | 16.5 | 64x155 | 16.5 | 76x155 | 20.2 |
| | | | | 76x120 | 17.2 | 76x120 | 18.0 | | |
| 4700 | | 64x130 | 16.9 | 64x155 | 18.1 | 76x145 | 20.8 | 90x135 | 21.8 |
| | | | | 76x130 | 20.8 | 90x120 | 21.8 | | |
| 5600 | | 64x155 | 19.8 | 76x140 | 22.7 | 76x160 | 24.2 | 90x160 | 25.3 |
| | | 76x120 | 21.6 | 90x120 | 23.8 | 90x135 | 24.9 | | |
| 6800 | | 76x145 | 25.0 | 76x160 | 26.6 | 90x160 | 29.4 | 90x175 | 29.0 |
| | | 90x120 | 26.2 | 90x135 | 27.4 | | | | |
| 8200 | | 76x160 | 29.3 | 90x160 | 32.2 | 90x160 | 32.2 | | |
| | | 90x135 | 30.1 | | | | | | |
| 10000 | | 90x160 | 35.7 | 90x160 | 35.7 | 90x175 | 36.9 | | |
| 12000 | | 90x160 | 39.1 | | | | | | |

STD Series

- Load life: 85°C 5000Hours high voltage Screw terminal type.
- Suitable for use in industrial equipment industrial power,
- Suitable for Solar pv inverter, wind power, Marine, heavy trucks, and other fields.
- RoHS Compliant & Halogen Free

Specifications

| Items | Characteristics | | | | |
|-----------------------------|---|---|------|------|------|
| Capacitance Tolerance | ± 20% (120Hz, 20°C) | | | | |
| Operating Temperature Range | -25 ~ +85°C | | | | |
| Rated Voltage Range | 500 ~ 650VDC | | | | |
| Rated Capacitance Range | 220 ~ 1,000,000μF | | | | |
| Leakage Current | I ≤ 0.02CV (μA) or 5mA, which is greater. (After 5 minutes application of DC rated voltage, at 20°C) | | | | |
| Dissipation Factor | Measurement Frequency: 120Hz. Temperature: 20°C | | | | |
| | Rated Voltage (V) | 500 | 550 | 600 | 650 |
| | tan δ (Max) | 0.25 | 0.25 | 0.25 | 0.25 |
| Temperature Stability | Measurement Frequency: 120Hz. | | | | |
| | Capacitance Change C (-25°C) / Z (20°C) ≥ 0.6 | | | | |
| Load Life | 5,000 hours, with application of rated voltage at 85°C | | | | |
| | Capacitance Change | Within ± 20% of Initial Value | | | |
| | tan δ | 200% or less of Initial Specified Value | | | |
| | Leakage Current | Initial Specified Value or less | | | |
| Shelf Life | The following specifications shall be satisfied when the capacitors are restored to 20°C after exposing them for 500 hours 85°C without voltage applied. Before the measurement the capacitor shall be preconditioned by applying voltage according to them 4.1 of JIS C5101-4. | | | | |
| | Capacitance Change | Within ± 20% of Initial Value | | | |
| | tan δ | 200% or less of Initial Specified Value | | | |
| | Leakage Current | Initial Specified Value or less | | | |
| Standards | JIS C-5101-4(IEC 60384) | | | | |

Frequency Coefficient for Ripple Current

| Rated Voltage (V) | Frequency (Hz) | | | | |
|-------------------|----------------|------|------|------|------|
| | 50 | 120 | 360 | 1K | ≥ 3K |
| 500 ~ 650 | 0.80 | 1.00 | 1.20 | 1.30 | 1.40 |

The endurance of capacitors is reduced with internal heating produced by ripple current at the rate of halving the lifetime with every 5°C rise.

When long life performance is required in actual use, the RMS ripple current has to be reduced.

STD Series

Dimensions (mm)

Screw terminal type for $\phi 51$ and larger

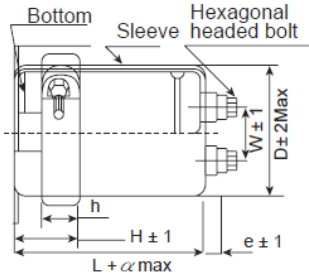

3-leg brackets for $\phi 90$ capacitors have different hole shapes from the ordinary ones as illustrated below.

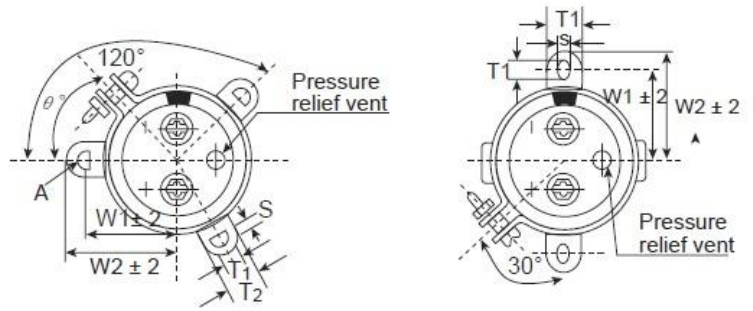
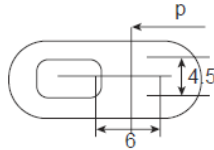

Terminal Pitch (W) & LENGTH (e) TABLE

| ϕD | W | e | α |
|----------|------|----|----------|
| 51 | 22 | 6 | 3 |
| 64 | 28.6 | 6 | 3 |
| 76 | 31.8 | 6 | 3 |
| 90 | 31.8 | 6 | 3 |
| 100 | 41.5 | 10 | 4 |

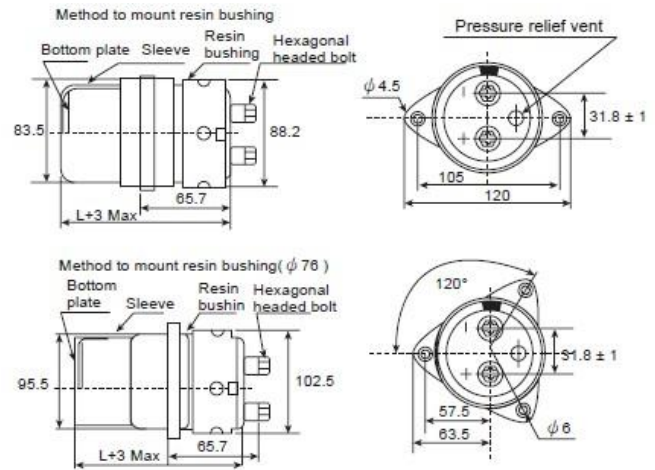

Dimensions of Mounting Bracket (mm)

| Cap (μF) | Leg Shape | 3-Legs | | | | | 2-Legs | | | |
|----------|----------------|-----------|-----------|-----------|-----------|------------|-----------|-----------|-----------|-----------|
| | | $\phi 51$ | $\phi 64$ | $\phi 76$ | $\phi 90$ | $\phi 100$ | $\phi 51$ | $\phi 64$ | $\phi 76$ | $\phi 90$ |
| | W1 | 32.5 | 38 | 44.5 | 50.8 | 56.3 | 33.2 | 40.5 | 46.5 | 53 |
| | W2 | 38.5 | 43 | 49.2 | 57 | 62 | 40 | 46.5 | 53 | 59 |
| | T1 | 7.5 | 8.0 | 7.0 | 7.0 | 8.0 | 6.0 | 6.0 | 6.0 | 6.0 |
| | T2 | 12 | 14 | 14 | 16 | 16 | 14 | 14 | 14 | 14 |
| | S | 5.0 | 5.0 | 5.0 | 5.0 | 5.0 | 4.5 | 4.5 | 4.5 | 4.5 |
| | θ° | 60 | 60 | 60 | 60 | 60 | 30 | 30 | 30 | 30 |
| | H | 20 | 25 | 30 | 35 | 36 | 25 | 35 | 35 | 35 |
| | h | 15 | 20 | 24 | 20 | 30 | 15 | 20 | 20 | 20 |

STD Series

Standard Ratings

DxL(mm);R.C.(A rms) at 85°C 120Hz.

| Cap (µF) | V | 500 | | 550 | | 600 | | 650 | |
|----------|------|---------|------|---------|------|--------|------|--------|------|
| | Item | D x L | R.C. | D x L | R.C. | D x L | R.C. | D x L | R.C. |
| 1000 | | | | 51x95 | 5.4 | | | 64x100 | 6.3 |
| 1200 | | 51x95 | 5.9 | 51x110 | 6.3 | 64x95 | 6.7 | 64x110 | 7.2 |
| 1500 | | 51x115 | 7.2 | 51x130 | 7.6 | 64x110 | 8.0 | 64x130 | 8.6 |
| 1800 | | 51x130 | 8.3 | 64x105 | 8.6 | 64x125 | 9.3 | 64x150 | 10.1 |
| 2200 | | 51x150 | 9.8 | 64x120 | 10.1 | 64x145 | 11 | 64x170 | 11.7 |
| 2700 | | 64x120 | 11.2 | 64x150 | 12.4 | 64x170 | 13.1 | 76x150 | 13.6 |
| | | | | 76x105 | 11.7 | 76x125 | 12.6 | | |
| 3300 | | 64x140 | 13.3 | 64x170 | 14.5 | 76x145 | 14.9 | 76x170 | 15.8 |
| | | | | 76x130 | 14.2 | | | | |
| 3900 | | 64x170 | 15.7 | 76x140 | 15.9 | 76x170 | 17.3 | 90x155 | 15.3 |
| | | 76x130 | 15.4 | | | 90x130 | 14.2 | | |
| 4700 | | 76x150 | 18.1 | 76x170 | 19.1 | 76x190 | 20.0 | 90x190 | 18.4 |
| | | | | 90x130 | 15.6 | 90x150 | 16.6 | | |
| 5600 | | 76x170 | 20.8 | 90x150 | 18.2 | 90x170 | 19.1 | | |
| | | 90x130 | 17.1 | | | | | | |
| 6800 | | 90x150 | 20 | 90x170 | 21.1 | | | | |
| 8200 | | 90x190 | 24.4 | 100x170 | 24.8 | | | | |
| 10000 | | 90x210 | 28.2 | 100x200 | 29.4 | | | | |
| 12000 | | 100x210 | 32.9 | | | | | | |
| 15000 | | 100x250 | 39.8 | | | | | | |

STE Series

- Load life: 85°C 10000Hours Screw terminal type.
- Suitable for use in industrial equipment industrial power,
- solar pv inverter, wind power, Marine, heavy trucks, and other fields.
- RoHS Compliant & Halogen Free

Specifications

| Items | Characteristics | | | |
|-----------------------------|---|---|------|------|
| Capacitance Tolerance | ± 20% (120Hz, 20°C) | | | |
| Operating Temperature Range | -25 ~ +85°C | | | |
| Rated Voltage Range | 350 ~ 450VDC | | | |
| Rated Capacitance Range | 220 ~ 1,000,000μF | | | |
| Leakage Current | I ≤ 0.02CV (μA) or 5mA, which is greater. (After 5 minutes application of DC rated voltage, at 20°C) | | | |
| Dissipation Factor | Measurement Frequency: 120Hz. Temperature: 20°C | | | |
| | Rated Voltage (V) | 350 | 400 | 450 |
| | tan δ (Max) | 0.15 | 0.15 | 0.15 |
| Temperature Stability | Measurement Frequency: 120Hz. | | | |
| | Capacitance Change C (-25°C) / Z(20°C) ≥ 0.6 | | | |
| Load Life | 10,000 hours, with application of rated voltage at 85°C | | | |
| | Capacitance Change | Within ± 20% of Initial Value | | |
| | tan δ | 200% or less of Initial Specified Value | | |
| | Leakage Current | Initial Specified Value or less | | |
| Shelf Life | The following specifications shall be satisfied when the capacitors are restored to 20°C after exposing them for 500 hours 85°C without voltage applied. Before the measurement the capacitor shall be preconditioned by applying voltage according to them 4.1 of JIS C5101-4. | | | |
| | Capacitance Change | Within ± 20% of Initial Value | | |
| | tan δ | 200% or less of Initial Specified Value | | |
| | Leakage Current | Initial Specified Value or less | | |
| Standards | JIS C-5101-4(IEC 60384) | | | |

Frequency Coefficient for Ripple Current

| Rated Voltage (V) | Frequency (Hz) | | | | |
|-------------------|----------------|------|------|------|-------|
| | 50 | 120 | 300 | 1K | ≥ 10K |
| 350 ~ 450 | 0.80 | 1.00 | 1.20 | 1.30 | 1.40 |

The endurance of capacitors is reduced with internal heating produced by ripple current at the rate of halving the lifetime with every 5°C rise. When long life performance is required in actual use, the RMS ripple current has to be reduced.

STE Series

Dimensions (mm)

Screw terminal type for $\phi 51$ and larger

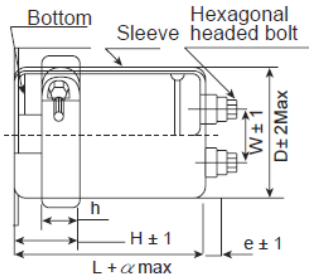

3-leg brackets for $\phi 90$ capacitors have different hole shapes from the ordinary ones as illustrated below.

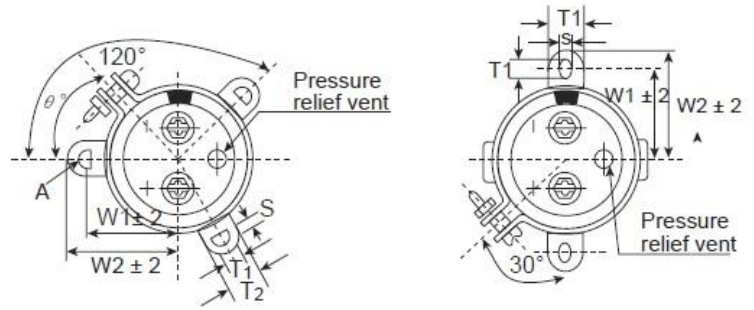
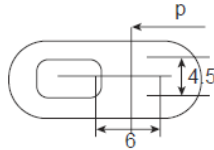

Terminal Pitch (W) & LENGTH (e) TABLE

| ϕD | W | e | α |
|----------|------|----|----------|
| 51 | 22 | 6 | 3 |
| 64 | 28.6 | 6 | 3 |
| 76 | 31.8 | 6 | 3 |
| 90 | 31.8 | 6 | 3 |
| 100 | 41.5 | 10 | 4 |

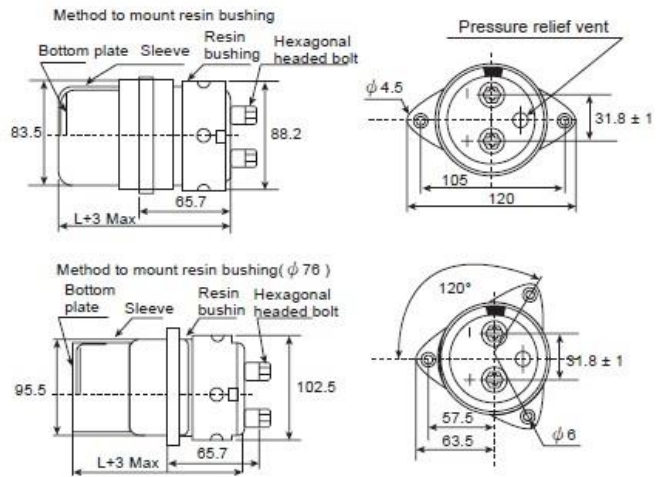

Dimensions of Mounting Bracket (mm)

| Cap (μF) | Leg Shape ϕD | 3-Legs | | | | | 2-Legs | | | |
|----------|-----------------------|-----------|-----------|-----------|-----------|------------|-----------|-----------|-----------|-----------|
| | | $\phi 51$ | $\phi 64$ | $\phi 76$ | $\phi 90$ | $\phi 100$ | $\phi 51$ | $\phi 64$ | $\phi 76$ | $\phi 90$ |
| | W1 | 32.5 | 38 | 44.5 | 50.8 | 56.3 | 33.2 | 40.5 | 46.5 | 53 |
| | W2 | 38.5 | 43 | 49.2 | 57 | 62 | 40 | 46.5 | 53 | 59 |
| | T1 | 7.5 | 8.0 | 7.0 | 7.0 | 8.0 | 6.0 | 6.0 | 6.0 | 6.0 |
| | T2 | 12 | 14 | 14 | 16 | 16 | 14 | 14 | 14 | 14 |
| | S | 5.0 | 5.0 | 5.0 | 5.0 | 5.0 | 4.5 | 4.5 | 4.5 | 4.5 |
| | θ° | 60 | 60 | 60 | 60 | 60 | 30 | 30 | 30 | 30 |
| | H | 20 | 25 | 30 | 35 | 36 | 25 | 35 | 35 | 35 |
| | h | 15 | 20 | 24 | 20 | 30 | 15 | 20 | 20 | 20 |

STE Series

Standard Ratings

DxL(mm);R.C.(A rms) at 85°C 120Hz.

| Cap (μF) | V | 350 | | 400 | | 500 | |
|----------|------|--------|------|--------|------|--------|------|
| | Item | D x L | R.C. | D x L | R.C. | D x L | R.C. |
| 1000 | | 51x85 | 5.5 | 51x85 | 5.0 | 51x85 | 5.0 |
| 1200 | | 51x85 | 5.5 | 51x85 | 5.5 | 51x95 | 6.0 |
| 1500 | | 51x85 | 6.1 | 51x95 | 6.7 | 51x115 | 7.2 |
| 1800 | | 51x95 | 7.4 | 51x95 | 7.4 | 51x130 | 8.3 |
| 2200 | | 51x95 | 8.2 | 51x130 | 9.2 | 64x95 | 9.0 |
| 2700 | | 51x130 | 10.2 | 64x95 | 9.9 | 64x115 | 10.7 |
| 3300 | | 51x130 | 11.3 | 64x115 | 11.8 | 64x130 | 12.4 |
| 3900 | | 64x115 | 12.8 | 64x130 | 13.5 | 76x115 | 13.6 |
| 4700 | | 64x130 | 14.8 | 76x115 | 14.9 | 76x130 | 15.6 |
| 5600 | | 76x115 | 16.3 | 76x130 | 17.0 | 76x155 | 18.3 |
| 6800 | | 76x130 | 18.8 | 76x155 | 20.2 | 90x155 | 21.4 |
| 8200 | | 76x155 | 22.1 | 90x155 | 23.5 | 90x155 | 23.5 |
| 10000 | | 90x155 | 25.9 | 90x155 | 25.9 | 90x195 | 28.3 |
| 12000 | | 90x155 | 28.4 | 90x195 | 31.0 | | |
| 15000 | | 90x195 | 34.6 | | | | |

LTC Series

- 85°C 2000hours, LUG terminal type.
- High ripple current resistance.
- Suitable for power supply, control circuit of inverter.
- RoHS Compliant & Halogen Free

Specifications

| Items | Characteristics | | | | | |
|--|---|---|--------------|-----------|----------|-----------|
| Capacitance Tolerance | ± 20% (120Hz, 20°C) | | | | | |
| Operating Temperature Range | -40 ~ +85°C | | -25 ~ +85°C | | | |
| Rated Voltage Range | 16 ~ 250VDC | | 315 ~ 450VDC | | | |
| Leakage Current | I ≤ 0.02CV (μA) or 5mA, which is greater. (After 5 minutes application of DC rated voltage, at 20°C) | | | | | |
| Dissipation Factor | Measurement Frequency: 120Hz. Temperature: 20°C | | | | | |
| | Rated Voltage (V) | 16 | 25 | 35 ~ 50 | 63 ~ 315 | 350 ~ 450 |
| | tan δ(Max) | 0.35 | 0.30 | 0.25 | 0.20 | 0.25 |
| | When nominal capacitance over 1000μF, tan δ shall be added 0.01 to the listed value with increase of every 1000μF. | | | | | |
| Low Temperature Stability Impedance Ratio (Max) | Measurement Frequency: 120Hz. | | | | | |
| | Rated Voltage(V) | 16 ~ 100 | | 160 ~ 250 | | 315 ~ 450 |
| | Z(-25°C)/Z(20°C) | 6 | | 4 | | 8 |
| | Z(-40°C)/Z(20°C) | 12 | | - | | - |
| Load Life | 2000 hours, with application of rated voltage at 85°C | | | | | |
| | Capacitance Change | Within ± 20% of Initial Value | | | | |
| | tan δ | 200% or less of Initial Specified Value | | | | |
| | Leakage Current | Initial Specified Value or less | | | | |
| Shelf Life | The following specifications shall be satisfied when the capacitors are restored to 20°C after exposing them for 1,000 hours 85°C without voltage applied. Before the measurement the capacitor shall be preconditioned by applying voltage according to them 4.1 of JIS C5101-4. | | | | | |
| | Capacitance Change | Within ± 20% of Initial Value | | | | |
| | tan δ | 200% or less of Initial Specified Value | | | | |
| | Leakage Current | Initial Specified Value or less | | | | |
| Standards | JIS C-5101-4(IEC 60384) | | | | | |

Frequency Coefficient of Permissible Ripple Current

| Rated Voltage (V) | Frequency (Hz) | | | |
|-------------------|----------------|------|------|-------|
| | 50 | 120 | 1K | ≥ 10K |
| 16 ~ 100 | 0.90 | 1.00 | 1.20 | 1.25 |
| 160 ~ 315 | 0.95 | 1.00 | 1.20 | 1.25 |
| 350 ~ 450 | 0.98 | 1.00 | 1.15 | 1.20 |

The endurance of capacitors is reduced with internal heating produced by ripple current at the rate of halving the lifetime with every 5°C rise. When long life performance is required in actual use, the RMS ripple current has to be reduced.

Dimensions (mm)

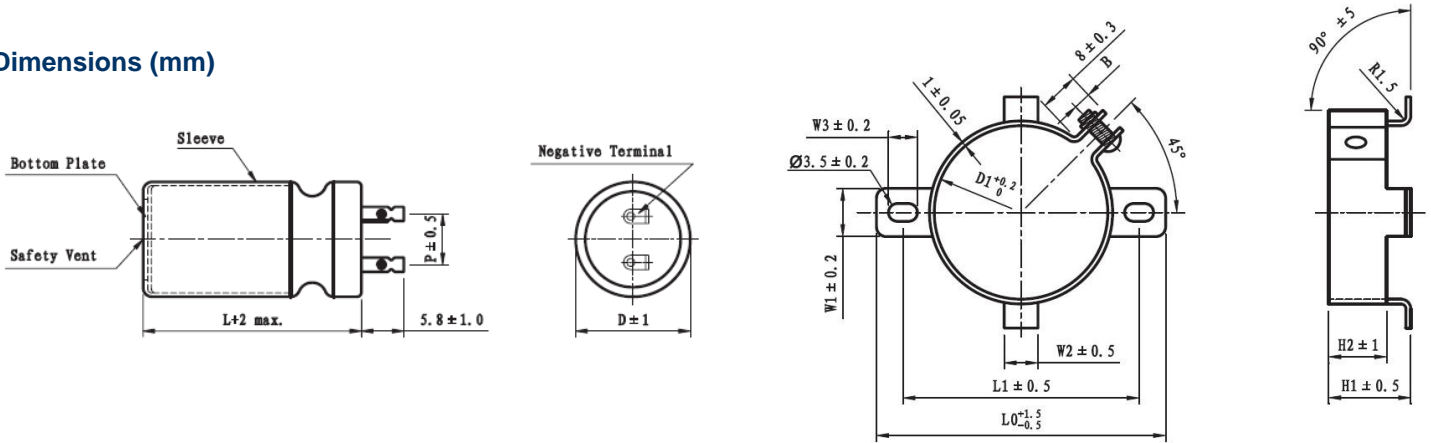

| Ø | P | W1 | W2 | W3 | D1 | L0 | B | H1 | H2 | L1 |
|----|------|------|-----|-----|------|------|-----|------|------|------|
| 25 | 10.0 | 11.0 | 3.5 | 6.0 | 25.4 | 48.0 | 3.5 | 10.0 | 8.0 | 38.0 |
| 30 | 10.0 | 11.0 | 3.5 | 6.0 | 30.0 | 52.0 | 4.0 | 11.0 | 9.0 | 42.0 |
| 35 | 14.0 | 11.0 | 3.5 | 6.0 | 34.9 | 58.0 | 3.5 | 15.0 | 10.0 | 48.0 |
| 40 | 18.0 | 14.0 | 3.5 | 7.0 | 40.0 | 65.0 | 3.0 | 18.5 | 12.5 | 53.5 |
| 51 | 20.0 | 14.0 | 4.0 | 7.0 | 51.0 | 72.0 | 5.5 | 18.5 | 15.0 | 61.0 |

Standard Ratings

DxL (mm); R.C. (A rms) at 85°C 120Hz.

| Cap (µF) | V | 16 | | 25 | | 35 | | 40 | | 50 | |
|----------|---|--------|-------|--------|-------|--------|-------|--------|-------|--------|-------|
| | | D x L | R.C. | D x L | R.C. | D x L | R.C. | D x L | R.C. | D x L | R.C. |
| 3300 | | | | | | | | 25x30 | 2.45 | 25x30 | 2.47 |
| 4700 | | | | | | 25x30 | 2.88 | 25x40 | 3.21 | 25x40 | 3.22 |
| 6800 | | | | 25x30 | 3.12 | 25x40 | 3.73 | 25x50 | 4.07 | 25x50 | 4.09 |
| 10000 | | 25x30 | 3.43 | 25x40 | 4.03 | 25x50 | 4.71 | 25x60 | 5.07 | 30x50 | 5.10 |
| 15000 | | 25x40 | 4.42 | 25x50 | 5.08 | 30x50 | 5.81 | 30x60 | 6.24 | 35x60 | 6.67 |
| 22000 | | 25x50 | 5.44 | 30x50 | 6.15 | 35x60 | 7.45 | 35x60 | 7.48 | 35x80 | 8.34 |
| 33000 | | 30x50 | 6.57 | 35x60 | 7.85 | 35x80 | 9.17 | 35x80 | 9.25 | 40x100 | 10.60 |
| 47000 | | 35x60 | 8.19 | 35x80 | 9.48 | 40x100 | 11.30 | 51x105 | 12.50 | 51x105 | 12.80 |
| 68000 | | 35x80 | 9.85 | 40x100 | 11.60 | 51x105 | 13.20 | | | | |
| 100000 | | 40x100 | 12.10 | 51x105 | 13.50 | | | | | | |
| 150000 | | 51x105 | 13.90 | | | | | | | | |

| Cap (µF) | V | 63 | | 80 | | 100 | | 160 | | 200 | |
|----------|---|--------|-------|--------|-------|--------|-------|--------|------|--------|------|
| | | D x L | R.C. | D x L | R.C. | D x L | R.C. | D x L | R.C. | D x L | R.C. |
| 330 | | | | | | | | 25x30 | 0.92 | 25x30 | 0.95 |
| 470 | | | | | | | | 25x40 | 1.22 | 25x40 | 1.25 |
| 680 | | | | | | | | 25x50 | 1.60 | 25x50 | 1.63 |
| 1000 | | | | | | 25x30 | 1.61 | 25x60 | 2.08 | 30x50 | 2.12 |
| 1500 | | | | 25x30 | 1.91 | 25x40 | 2.13 | 30x60 | 2.68 | 35x50 | 2.87 |
| 2200 | | 25x30 | 2.06 | 25x40 | 2.52 | 25x50 | 2.75 | 35x60 | 3.40 | 35x60 | 3.81 |
| 3300 | | 25x40 | 2.73 | 25x50 | 3.29 | 30x50 | 3.53 | 35x100 | 5.02 | 35x80 | 5.27 |
| 4700 | | 25x50 | 3.50 | 25x60 | 4.14 | 35x60 | 4.76 | 40x100 | 6.15 | 40x100 | 6.81 |
| 6800 | | 25x60 | 4.37 | 30x60 | 5.15 | 35x80 | 6.17 | 51x105 | 7.86 | 51x105 | 8.12 |
| 10000 | | 30x60 | 5.46 | 35x80 | 7.08 | 40x100 | 8.16 | | | | |
| 15000 | | 35x80 | 7.48 | 40x80 | 8.42 | 51x105 | 10.20 | | | | |
| 22000 | | 35x100 | 9.16 | 51x105 | 11.20 | | | | | | |
| 33000 | | 51x105 | 11.70 | | | | | | | | |

Standard Ratings

DxL (mm); R.C.(A rms) at 85°C 120Hz.

| Cap (µF) | V | 250 | | 315 | | 350 | | 400 | | 450 | |
|----------|------|--------|------|--------|------|--------|------|--------|------|--------|------|
| | Item | D x L | R.C. | D x L | R.C. | D x L | R.C. | D x L | R.C. | D x L | R.C. |
| 68 | | | | | | | | | | 25x30 | 0.38 |
| 100 | | | | | | 25x30 | 0.50 | 25x30 | 0.50 | 25x40 | 0.5 |
| 150 | | | | 25x30 | 0.61 | 25x40 | 0.69 | 25x40 | 0.62 | 25x50 | 0.68 |
| 220 | | 25x30 | 0.75 | 25x40 | 0.84 | 25x50 | 0.91 | 25x50 | 0.81 | 30x50 | 0.88 |
| 330 | | 25x40 | 1.02 | 25x50 | 1.12 | 25x60 | 1.21 | 30x60 | 1.15 | 35x60 | 1.24 |
| 470 | | 25x50 | 1.34 | 25x60 | 1.43 | 30x60 | 1.54 | 35x60 | 1.47 | 35x80 | 1.65 |
| 680 | | 30x50 | 1.73 | 30x60 | 1.85 | 35x60 | 1.98 | 35x80 | 1.98 | 35x100 | 2.18 |
| 1000 | | 30x60 | 2.25 | 35x70 | 2.56 | 35x100 | 2.95 | 40x100 | 2.78 | 51x80 | 2.77 |
| 1500 | | 35x80 | 3.21 | 35x100 | 3.54 | 40x100 | 3.72 | 51x105 | 3.69 | | |
| 2200 | | 35x100 | 4.19 | 40x100 | 4.41 | 51x105 | 4.86 | | | | |
| 3300 | | 51x80 | 5.24 | 51x105 | 5.82 | | | | | | |

LTD Series

- 105°C 2000hours, LUG terminal type.
- High temperature, high ripple current resistance.
- Suitable for machinery, filter circuit of tele-communication.
- RoHS Compliant & Halogen Free

Specifications

| Items | Characteristics | | | | |
|---|--|---|--------------|-----------|-----------|
| Capacitance Tolerance | ± 20% (120Hz, 20°C) | | | | |
| Operating Temperature Range | -40 ~ +105°C | | -25 ~ +105°C | | |
| Rated Voltage Range | 16 ~ 250VDC | | 315 ~ 450VDC | | |
| Leakage Current | I ≤ 0.02CV or 5mA which is greater. (After 5 minutes application of DC rated voltage, at 20°C) | | | | |
| Dissipation Factor | Measurement Frequency: 120Hz. Temperature: 20°C | | | | |
| | Rated Voltage (V) | 16 ~ 25 | 35 ~ 50 | 63 ~ 315 | 350 ~ 450 |
| | tan δ(Max) | 0.35 | 0.25 | 0.20 | 0.25 |
| When nominal capacitance over 1000μF, tanδ shall be added 0.01 to the listed value with increase of every 1000μF. | | | | | |
| Low Temperature Stability | Measurement Frequency: 120Hz. | | | | |
| | Rated Voltage(V) | 16 ~ 100 | 160 ~ 250 | 315 ~ 450 | |
| | Z(-25°C)/Z(20°C) | 6 | 4 | 8 | |
| Impedance Ratio (Max) | Z(-40°C)/Z(20°C) | 12 | 8 | - | |
| | 2000 hours, with application of rated Voltage at 105°C | | | | |
| Load Life | Capacitance Change | Within ± 25% of Initial Value | | | |
| | tan δ | 200% or less of Initial Specified Value | | | |
| | Leakage Current | Initial Specified Value or less | | | |
| | The following specifications shall be satisfied when the capacitors are restored to 20°C after exposing them for 1,000 hours 105°C without voltage applied. Before the measurement the capacitor shall be preconditioned by applying voltage according to them 4.1 of JIS C5101-4. | | | | |
| Shelf Life | Capacitance Change | Within ± 25% of Initial Value | | | |
| | tan δ | 200% or less of Initial Specified Value | | | |
| | Leakage Current | Initial Specified Value or less | | | |
| | Standards | | | | |
| JIS C-5101-4(IEC 60384) | | | | | |

Frequency Coefficient of Permissible Ripple Current

| Rated Voltage (V) | Frequency (Hz) | | | |
|-------------------|----------------|------|------|-------|
| | 50 | 120 | 1K | ≥ 10K |
| 16 ~ 100 | 0.90 | 1.00 | 1.20 | 1.25 |
| 160 ~ 315 | 0.95 | 1.00 | 1.20 | 1.25 |
| 350 ~ 450 | 0.98 | 1.00 | 1.15 | 1.20 |

The endurance of capacitors is reduced with internal heating produced by ripple current at the rate of halving the lifetime with every 5°C rise. When long life performance is required in actual use, the RMS ripple current has to be reduced.

LTD Series

Dimensions (mm)

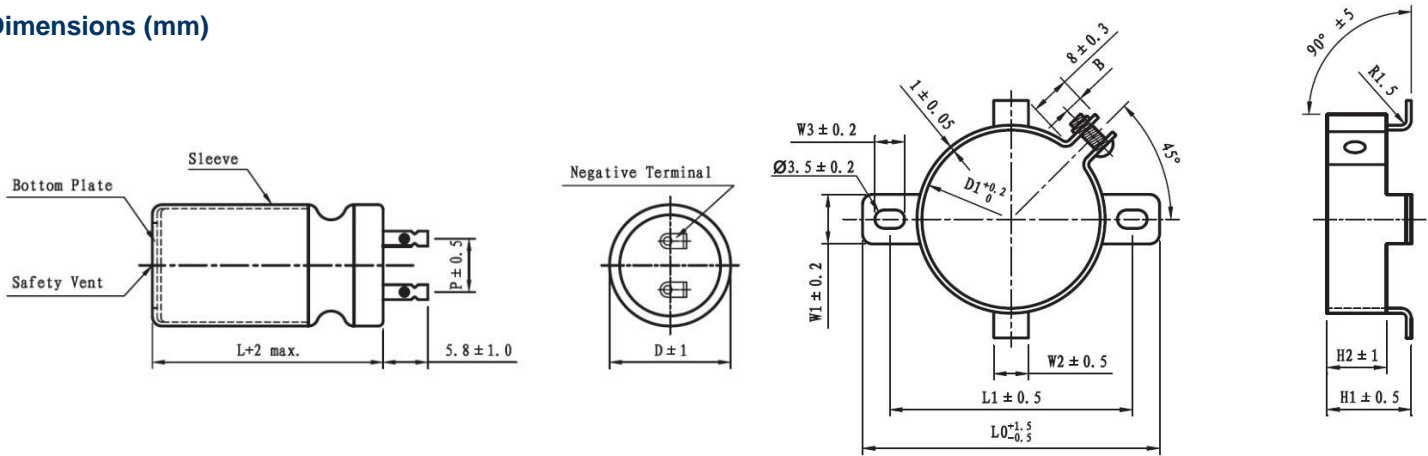

| \varnothing | P | W1 | W2 | W3 | D1 | L0 | B | H1 | H2 | L1 |
|---------------|------|------|-----|-----|------|------|-----|------|------|------|
| 25 | 10.0 | 11.0 | 3.5 | 6.0 | 25.4 | 48.0 | 3.5 | 10.0 | 8.0 | 38.0 |
| 30 | 10.0 | 11.0 | 3.5 | 6.0 | 30.0 | 52.0 | 4.0 | 11.0 | 9.0 | 42.0 |
| 35 | 14.0 | 11.0 | 3.5 | 6.0 | 34.9 | 58.0 | 3.5 | 15.0 | 10.0 | 48.0 |
| 40 | 18.0 | 14.0 | 3.5 | 7.0 | 40.0 | 65.0 | 3.0 | 18.5 | 12.5 | 53.5 |

Standard Ratings

DxL (mm); R.C. (A rms) at 105°C 120Hz.

| Cap (μ F) | V | 16 | | 25 | | 35 | | 50 | | 63 | | 80 | | 100 | |
|-------------------|-------|-------|-------|-------|-------|-------|-------|-------|-------|-------|-------|-------|-------|-------|------|
| | Item | D x L | R.C. | D x L | R.C. | D x L | R.C. | D x L | R.C. | D x L | R.C. | D x L | R.C. | D x L | R.C. |
| 470 | | | | | | | | | | 25x25 | 0.60 | 25x25 | 0.62 | 25x25 | 0.85 |
| 680 | | | | | | | | | | 25x25 | 0.80 | 25x25 | 1.03 | 25x25 | 1.10 |
| 1000 | | | | | | 25x25 | 0.50 | 25x25 | 0.80 | 25x25 | 1.10 | 25x35 | 1.30 | 25x40 | 1.40 |
| 1500 | | | | | | 25x25 | 0.80 | 25x25 | 1.10 | 25x25 | 1.50 | 25x35 | 1.70 | 25x40 | 1.80 |
| 2200 | 25x25 | 0.70 | 25x25 | 1.00 | 25x35 | 1.30 | 25x35 | 1.60 | 25x35 | 1.70 | 25x50 | 1.90 | 30x50 | 2.40 | |
| 3300 | 25x25 | 1.02 | 25x30 | 1.40 | 25x40 | 1.80 | 25x50 | 2.10 | 30x50 | 2.30 | 30x60 | 2.60 | 30x60 | 2.80 | |
| 4700 | 25x30 | 1.50 | 25x35 | 1.90 | 25x50 | 2.00 | 30x50 | 2.60 | 30x60 | 2.80 | 35x60 | 3.10 | 40x60 | 3.70 | |
| 6800 | 25x35 | 2.01 | 25x50 | 2.40 | 30x50 | 2.70 | 35x50 | 3.00 | 35x60 | 3.20 | 40x60 | 3.90 | 40x80 | 5.10 | |
| 10000 | 25x50 | 2.40 | 30x50 | 2.90 | 30x60 | 3.20 | 35x60 | 4.40 | 40x60 | 4.90 | 40x80 | 5.80 | | | |

| Cap (μ F) | V | 160 | | 200 | | 250 | | 315 | | 350 | | 400 | | 450 | |
|-------------------|-------|-------|-------|-------|-------|-------|-------|-------|-------|-------|-------|-------|-------|-------|------|
| | Item | D x L | R.C. | D x L | R.C. | D x L | R.C. | D x L | R.C. | D x L | R.C. | D x L | R.C. | D x L | R.C. |
| 22 | | | | | | | | | | | | | | 25x35 | 0.15 |
| 33 | | | | | | | | | | | | | | 25x50 | 0.21 |
| 47 | | | | | | | | | | | | 25x40 | 0.21 | 25x50 | 0.22 |
| 100 | | | | | | 25x50 | 0.43 | 25x50 | 0.44 | 25x50 | 0.45 | 30x50 | 0.48 | 30x60 | 0.53 |
| 150 | | | | | | 25x50 | 0.51 | 25x50 | 0.62 | 25x50 | 0.61 | 30x50 | 0.61 | 30x60 | 0.61 |
| 220 | 25x50 | 0.64 | 30x50 | 0.71 | 30x50 | 0.72 | 35x50 | 0.82 | 35x60 | 0.82 | 35x80 | 0.82 | 35x80 | 0.92 | |
| 330 | 30x50 | 0.92 | 30x60 | 0.92 | 35x60 | 1.03 | 35x80 | 1.05 | 35x80 | 1.10 | 40x80 | 1.10 | | | |
| 470 | 30x60 | 1.20 | 35x60 | 1.20 | 35x80 | 1.30 | 40x80 | 1.40 | 40x80 | 1.50 | | | | | |
| 680 | 35x60 | 1.60 | 40x60 | 1.70 | 40x80 | 1.80 | | | | | | | | | |
| 1000 | 35x80 | 2.20 | | | | | | | | | | | | | |

RHA Series

- 105°C high-temperature, high reliability and long life
- Suitable for office communicative or industrial equipment
- RoHS Compliant & Halogen Free

Specifications

| Items | Characteristics | | | | | | | | | | | | |
|-----------------------------|---|---|------|-------|-----|------|---|--------------|------|---------|---------|------|------|
| Capacitance Tolerance | ± 20% (120Hz, 20°C) | | | | | | | | | | | | |
| Operating Temperature Range | - | | | -40 ~ | | | | -25 ~ +105°C | | | | | |
| Rated Voltage Range | 6.3 ~ 100VDC | | | 160 ~ | | | | 350 ~ 450VDC | | | | | |
| Leakage Current | I ≤ 0.01CV or 3 (μA) which is greater. (After 2 minutes | | | | | | I ≤ 0.03CV +20 (μA) (After 3 minutes application of DC rated voltage, at 20 °C) | | | | | | |
| Dissipation Factor | Measurement Frequency: 120Hz. Temperature: 20°C | | | | | | | | | | | | |
| | Rated Voltage (V) | 6.3 | 10 | 16 | 25 | 35 | 50 | 63 | 100 | 160~25 | 350~4 | 500 | 600 |
| | tan δ(Max) | 0.24 | 0.20 | 0.17 | 0.1 | 0.12 | 0.10 | 0.09 | 0.08 | 0.15 | 0.20 | 0.20 | 0.25 |
| | When nominal capacitance over 1000μF, tan δ shall be added 0.02 to the listed value with increase of every 1000μF | | | | | | | | | | | | |
| Low Temperature Stability | Measurement Frequency: 120Hz. | | | | | | | | | | | | |
| | Rated Voltage(V) | 6.3 | 10 | 16 | 25 | 35 | 50 | 63 | 100 | 160~250 | 350~400 | 450 | |
| | Z(-25°C)/Z(20°C) | 4 | 3 | 3 | 2 | 2 | 2 | 2 | 2 | 4 | 8 | 15 | |
| Impedance Ratio (Max) | Z(-40°C)/Z(20°C) | 8 | 6 | 4 | 4 | 4 | 4 | 4 | 4 | 6 | - | - | |
| | | | | | | | | | | | | | |
| Load Life | The following specification shall be satisfied when the capacitors are restored to 20°C after subjected to DC Voltage with the rated ripple current is applied for 5000 hours, (ψD ≤ 8 : 3,000 hrs : ψD = 10 : 4,000 hrs) at 105°C | | | | | | | | | | | | |
| | Capacitance Change | Within ± 20% of Initial Value | | | | | | | | | | | |
| | tan δ | 200% or less of Initial Specified Value | | | | | | | | | | | |
| | Leakage Current | Initial Specified Value or less | | | | | | | | | | | |
| Shelf Life | The following specifications shall be satisfied when the capacitors are restored to 20°C after exposing them for 1,000 hours 105°C without voltage applied. Before the measurement, the capacitor shall be preconditioned by applying voltage according to them 4.1 of JIS C5101-4. | | | | | | | | | | | | |
| | Capacitance Change | Within ± 20% of Initial Value | | | | | | | | | | | |
| | tan δ | 200% or less of Initial Specified Value | | | | | | | | | | | |
| | Leakage Current | Initial Specified Value or less | | | | | | | | | | | |
| Standards | JIS C-5101-4(IEC 60384) | | | | | | | | | | | | |

Frequency Coefficient of Permissible Ripple Current

| Rated Voltage (V) | Capacitance (μF) | Frequency (Hz) | | | |
|-------------------|------------------|----------------|------|------|-------|
| | | 50 | 120 | 1K | ≥ 10K |
| ≦ 100 | < 100 | 0.70 | 1.00 | 1.40 | 1.60 |
| | 100 ~ 4700 | 0.75 | 1.00 | 1.30 | 1.40 |
| | > 4700 | 0.80 | 1.00 | 1.15 | 1.20 |
| ≧ 160 | 2.2 ~ 820 | 0.80 | 1.00 | 1.30 | 1.40 |

The endurance of capacitors is reduced with internal heating produced by ripple current at the rate of halving the lifetime with every 5°C rise. When long life performance is required in actual use, the rms ripple current has to be reduced.

RHA Series

Dimensions (mm)

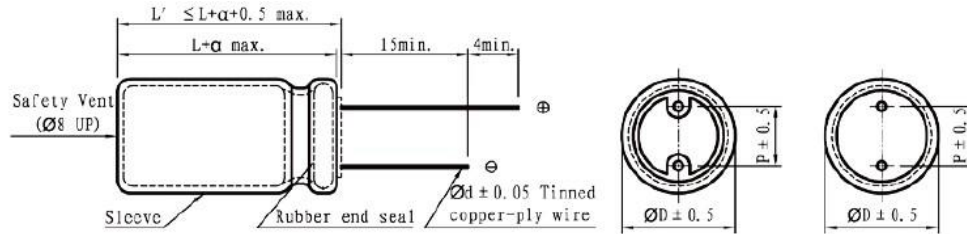

| | | | | | | | | | | |
|----|-----|-----|-----|-----|-----|------|-----|-----|-----|------|
| ØD | 5 | 6.3 | 8 | 10 | 13 | 14.5 | 16 | 18 | 22 | 25 |
| P | 2.0 | 2.5 | 3.5 | 5.0 | 5.0 | 7.5 | 7.5 | 7.5 | 10 | 12.5 |
| Ød | 0.5 | 0.5 | 0.5 | 0.6 | 0.6 | 0.8 | 0.8 | 0.8 | 0.8 | 1.0 |

Standard Ratings

DxL(mm) ; R.C.(mA rms) at 105°C 120Hz.

| Cap (µF) | V Item | 6.3 | | 10 | | 16 | | 25 | | 35 | | 50 | | 63 | |
|----------|--------|--------|------|--------|------|--------|------|--------|------|--------|------|--------|------|--------|------|
| | | D x L | R.C. | D x L | R.C. | D x L | R.C. | D x L | R.C. | D x L | R.C. | D x L | R.C. | D x L | R.C. |
| 0.47 | | | | | | | | | | | | 5x11 | 8 | | |
| 1 | | | | | | | | | | | | 5x11 | 17 | | |
| 2.2 | | | | | | | | | | | | 5x11 | 23 | | |
| 3.3 | | | | | | | | | | | | 5x11 | 31 | | |
| 4.7 | | | | | | | | | | | | 5x11 | 35 | | |
| 10 | | | | | | | | 5x11 | 45 | 5x11 | 48 | 5x11 | 51 | 5x11 | 56 |
| 22 | | | | | | | | 5x11 | 60 | 6.3x11 | 78 | 6.3x11 | 85 | 6.3x11 | 95 |
| 33 | | | | | | | | 6.3x11 | 90 | 6.3x11 | 100 | 8x12 | 102 | 8x12 | 122 |
| 47 | | | | | | 5x11 | 85 | 6.3x11 | 105 | 8x12 | 130 | 8x12 | 141 | 10x13 | 152 |
| 100 | | 5x11 | 120 | 5x11 | 130 | 6.3x11 | 140 | 8x12 | 185 | 8x12 | 190 | 10x13 | 231 | 10x16 | 250 |
| 220 | | 6.3x11 | 170 | 6.3x11 | 190 | 8x12 | 240 | 10x13 | 290 | 10x13 | 320 | 10x16 | 368 | 10x20 | 415 |
| 330 | | 8x12 | 250 | 8x12 | 280 | 8x12 | 310 | 10x13 | 350 | 10x16 | 420 | 10x20 | 490 | 13x21 | 550 |
| 470 | | 8x12 | 290 | 8x12 | 330 | 10x13 | 380 | 10x20 | 465 | 13x21 | 580 | 13x21 | 665 | 16x26 | 725 |
| 1000 | | 10x13 | 490 | 10x16 | 580 | 10x20 | 670 | 13x21 | 830 | 13x25 | 1000 | 16x26 | 1080 | 16x32 | 1135 |
| 2200 | | 10x20 | 830 | 13x21 | 970 | 13x25 | 1130 | 16x26 | 1210 | 16x32 | 1450 | 18x35 | 1695 | | |
| 3300 | | 13x21 | 1060 | 13x25 | 1250 | 16x26 | 1350 | 16x32 | 1540 | 18x35 | 1830 | 18x40 | 2070 | | |
| 4700 | | 13x25 | 1310 | 16x26 | 1400 | 16x32 | 1570 | 18x35 | 1870 | 18x40 | 2150 | | | | |
| 6800 | | 16x26 | 1430 | 16x32 | 1690 | 18x35 | 1930 | 18x40 | 2120 | | | | | | |
| 10000 | | 16x32 | 1790 | 18x35 | 2010 | 18x40 | 2190 | | | | | | | | |
| 15000 | | 18x35 | 1980 | 18x40 | 2260 | | | | | | | | | | |
| 22000 | | 18x40 | 2290 | | | | | | | | | | | | |

| Cap (µF) | V Item | 100 | | 160 | | 200 | | 250 | | 350 | | 400 | | 450 | |
|----------|--------|--------|------|--------|------|--------|------|-------|------|-------|------|-------|------|-------|------|
| | | D x L | R.C. | D x L | R.C. | D x L | R.C. | D x L | R.C. | D x L | R.C. | D x L | R.C. | D x L | R.C. |
| 2.2 | | 5x11 | 28 | 6.3x11 | 28 | 6.3x11 | 28 | 8x12 | 35 | 8x12 | 35 | 8x12 | 35 | 10x13 | 36 |
| 3.3 | | 5x11 | 34 | 8x12 | 34 | 8x12 | 35 | 8x12 | 50 | 8x12 | 44 | 8x12 | 50 | 10x13 | 48 |
| 4.7 | | 5x11 | 40 | 8x12 | 43 | 10x13 | 50 | 8x12 | 55 | 10x13 | 55 | 10x13 | 60 | 10x16 | 60 |
| 10 | | 6.3x11 | 66 | 10x13 | 75 | 10x16 | 80 | 10x16 | 100 | 10x20 | 92 | 10x20 | 100 | 13x21 | 110 |
| 22 | | 8x12 | 112 | 10x16 | 130 | 10x20 | 140 | 13x21 | 170 | 13x21 | 162 | 13x25 | 190 | 16x22 | 210 |
| 33 | | 10x13 | 155 | 10x20 | 170 | 13x21 | 200 | 13x21 | 225 | 13x25 | 205 | 16x22 | 240 | 16x26 | 280 |
| 39 | | 10x13 | 160 | 10x20 | 190 | 13x21 | 220 | 13x25 | 250 | 16x22 | 220 | 16x26 | 300 | 16x32 | 330 |
| 47 | | 10x16 | 190 | 13x21 | 230 | 13x21 | 250 | 13x25 | 280 | 16x26 | 320 | 16x32 | 330 | 18x25 | 360 |
| 68 | | 10x20 | 210 | 13x25 | 260 | 13x25 | 280 | 16x22 | 310 | 16x26 | 350 | 18x25 | 350 | 18x32 | 500 |
| 82 | | 13x21 | 240 | 16x22 | 320 | 16x26 | 350 | 16x32 | 390 | 18x25 | 420 | 18x32 | 580 | 18x35 | 600 |
| 100 | | 13x21 | 310 | 16x26 | 350 | 16x32 | 480 | 16x36 | 500 | 18x32 | 550 | 18x35 | 660 | 18x40 | 720 |
| 120 | | | | | | | | | | 18x35 | 650 | 18x40 | 770 | | |
| 220 | | 16x26 | 540 | 18x35 | 640 | 18x40 | 810 | | | | | | | | |
| 330 | | 16x26 | 660 | | | | | | | | | | | | |
| 470 | | 16x32 | 880 | | | | | | | | | | | | |
| 560 | | | | 22x40 | 1300 | 22x50 | 1400 | | | | | | | | |
| 680 | | | | 22x50 | 1420 | 25x50 | 1550 | | | | | | | | |
| 820 | | | | | | 25x50 | 1700 | | | | | | | | |

※ 13mm may be replaced by 12.5mm upon customer's request.

RHA Series

SLIM TYPE

- 105°C high-temperature and high voltage 350~450V, life 3000~5000hrs
- Specially Size, 8~16mm diameter
- For LCD-TV and LCD-Monitor power
- RoHS Compliant

Standard Ratings

DxL(mm); R.C.(mA rms) at 105°C 120Hz.

| Cap (μF) | V | 350 | | 400 | | 450 | |
|----------|------|---------|------|---------|------|---------|------|
| | Item | D x L | R.C. | D x L | R.C. | D x L | R.C. |
| 22 | | | | 8x50 | 135 | 10x40 | 280 |
| 33 | | | | 8x61 | 280 | 10x50 | 350 |
| | | 10x40 | 210 | 10x40 | 260 | 13x35 | 300 |
| 39 | | 10x40 | 210 | 8x61 | 280 | 8x61 | 350 |
| | | 13x30 | 270 | 10x45 | 300 | 10x50 | 350 |
| | | | | 13x35 | 310 | 13x40 | 360 |
| 47 | | 10x40 | 300 | 10x50 | 330 | 10x60 | 410 |
| | | 13x35 | 320 | 13x40 | 350 | 13x50 | 370 |
| | | 14.5x30 | 320 | 14.5x40 | 370 | 14.5x40 | 390 |
| 53 | | 13x35 | 320 | 13x50 | 385 | 10x60 | 440 |
| 68 | | 10x60 | 400 | 13x50 | 385 | 13x60 | 450 |
| | | 13x40 | 420 | 14.5x45 | 400 | 14.5x50 | 400 |
| | | 16x35 | 430 | 16x35 | 420 | 16x40 | 440 |
| 82 | | 13x50 | 450 | 14.5x45 | 530 | 14.5x50 | 600 |
| | | 16x35 | 500 | 16x40 | 550 | 16x45 | 620 |
| 100 | | 16x40 | 530 | 14.5x50 | 700 | 16x50 | 760 |
| | | | | 16x45 | 720 | | |

※ 13mm may be replaced by 12.5mm upon customer's request.

RHB Series

- 105°C high-temperature resistance, high reliability and long life
- High ripple current
- Suitable for office communicative or industrial equipment
- RoHS Compliant & Halogen Free

Specifications

| Items | Characteristics | | | |
|-----------------------------|---|---|--------------|-----|
| Capacitance Tolerance | ± 20% (120Hz, 20°C) | | | |
| Operating Temperature Range | -40 ~ +105°C | | -25 ~ +105°C | |
| Rated Voltage Range | 160 ~ 400VDC | | 450VDC | |
| Leakage Current | I ≤ 0.03CV +20 (μA) (After 3 minutes application of DC rated voltage) | | | |
| Dissipation Factor | Measurement Frequency: 120Hz. Temperature: 20°C | | | |
| | Rated Voltage (V) | 160 ~ 250 | 400 ~ 450 | |
| | tan δ(Max) | 0.15 | 0.20 | |
| Low Temperature Stability | Measurement Frequency: 120Hz. | | | |
| | Rated Voltage(V) | 160 ~ 250 | 400 | 450 |
| | Impedance Ratio (Max) | Z(-25°C) / Z(20°C) | 3 | 5 |
| Load Life | Z(-40°C) / Z(20°C) | | | |
| | 6 | | | |
| | 6 | | | |
| Shelf Life | The following specifications shall be satisfied when the capacitors are restored to 20°C after subjected to DC voltage with the rated ripple current is applied for 5,000 hours at 105°C. | | | |
| | Capacitance Change | Within ± 25% of Initial Value | | |
| | tan δ | 200% or less of Initial Specified Value | | |
| | Leakage Current | Initial Specified Value or less | | |
| Standards | The following specifications shall be satisfied when the capacitors are restored to 20°C after exposing them for 1,000 hours 105°C without voltage applied. Before the measurement, the capacitor shall be preconditioned by applying voltage according to them 4.1 of JIS C5101-4. | | | |
| | Capacitance Change | Within ± 20% of Initial Value | | |
| | tan δ | 200% or less of Initial Specified Value | | |
| | Leakage Current | Initial Specified Value or less | | |
| Standards | JIS C-5101-4(IEC 60384) | | | |

Frequency Coefficient of Permissible Ripple Current

| Capacitance (μF) | Frequency (Hz) | | | |
|------------------|----------------|------|------|------|
| | 120 | 1K | 10K | 100K |
| 22 ~ 82 | 1.00 | 1.25 | 1.50 | 1.75 |
| 100 ~ 470 | 1.00 | 1.15 | 1.30 | 1.40 |

The endurance of capacitors is reduced with internal heating produced by ripple current at the rate of halving the lifetime with every 5°C rise. When long life performance is required in actual use, the rms ripple current has to be reduced.

RHB Series

Dimensions (mm)

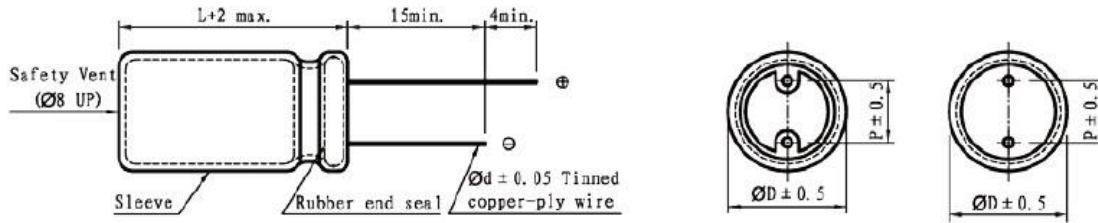

| ØD | 10 | 13 | 14.5 | 16 | 18 | 20 |
|----|-----|-----|------|-----|-----|------|
| P | 5.0 | 5.0 | 7.5 | 7.5 | 7.5 | 10.0 |
| Ød | 0.6 | 0.6 | 0.8 | 0.8 | 0.8 | 0.8 |

Standard Ratings

D×L(mm) ; R.C.(mA rms) at 105°C 120Hz.

| Cap (µF) | V | 160 | | 200 | | 250 | | 400 | | 450 | |
|-------------|---|-------|------|---------|------|-------|------|---------|------|---------|------|
| | | D x L | R.C. | D x L | R.C. | D x L | R.C. | D x L | R.C. | D x L | R.C. |
| 22 | | 10x16 | 130 | | | | | 10x30 | 205 | 10x40 | 280 |
| 33 | | 10x20 | 210 | | | | | 10x40 | 260 | 13x35 | 290 |
| 39 | | 10x20 | 210 | | | | | 10x45 | 320 | 13x40 | 345 |
| 47 | | 10x25 | 305 | | | | | 13x35 | 385 | 10x50 | 350 |
| | | | | | | | | | | 14.5x40 | 420 |
| 56 | | 10x25 | 305 | | | | | 13x40 | 420 | 14.5x40 | 420 |
| | | | | | | | | | | 16x30 | 477 |
| 68 | | 10x25 | 345 | 10x30 | 445 | 13x25 | 490 | 13x45 | 500 | 14.5x45 | 550 |
| | | | | | | | | 14.5x30 | 500 | 18x32 | 550 |
| 82 | | 10x30 | 445 | 10x35 | 485 | 13x30 | 550 | 14.5x40 | 545 | 16x40 | 650 |
| | | | | | | | | | | 18x32 | 650 |
| 100 | | 10x35 | 485 | 10x40 | 560 | 16x25 | 620 | 14.5x45 | 600 | 18x36 | 720 |
| | | | | | | | | 18x32 | 600 | | |
| 120 | | 10x40 | 560 | 10x45 | 680 | 16x32 | 685 | 16x40 | 710 | 18x40 | 800 |
| | | | | | | | | 18x36 | 710 | | |
| 150 | | 10x45 | 680 | 13x35 | 720 | 16x35 | 815 | 18x40 | 835 | 18x45 | 960 |
| | | | | | | | | | | 20x40 | 1000 |
| 220 | | 13x40 | 850 | 13x45 | 890 | 18x36 | 1020 | | | | |
| | | | | 14.5x35 | 890 | | | | | | |
| 270 | | 13x45 | 945 | 16x35 | 1030 | 18x40 | 1090 | | | | |
| | | | | 16x40 | 1200 | | | | | | |
| 330 | | 16x35 | 1100 | 18x32 | 1200 | | | | | | |
| | | | | 18x45 | 1305 | | | | | | |
| 470 | | 18x40 | 1220 | 18x45 | 1305 | | | | | | |

※ 13mm may be replaced by 12.5mm upon customer's request.

RHC Series

- High ripple current
- 8000~10000 hours long life product
- RoHS Compliant & Halogen Free

Specifications

| Items | Characteristics | | | | | | | |
|--|---|---|------|--------------|------|------|------|------|
| Capacitance Tolerance | ± 20% (120Hz, 20°C) | | | | | | | |
| Operating Temperature Range | -40 ~ +105°C | | | -25 ~ +105°C | | | | |
| Rated Voltage Range | 160 ~ 400VDC | | | 450VDC | | | | |
| Leakage Current | I ≤ 0.04CV +100 (µA) (After 1minutes application of DC rated voltage, at 20 °C) | | | | | | | |
| Dissipation Factor | Measurement Frequency: 120Hz. Temperature: 20°C | | | | | | | |
| | Rated Voltage (V) | 160 | 200 | 250 | 350 | 400 | 420 | 450 |
| | tan δ(Max) | 0.15 | 0.15 | 0.15 | 0.20 | 0.20 | 0.20 | 0.20 |
| When nominal capacitance over 1000µF, tan δ shall be added 0.02 to the listed value with increase of every 1000µF. | | | | | | | | |
| Low Temperature Stability | Measurement Frequency: 120Hz. | | | | | | | |
| | Rated Voltage(V) | 160 | 200 | 250 | 350 | 400 | 450 | |
| Impedance Ratio (Max) | Z(-25°C)/Z(20°C) | 3 | 3 | 3 | 6 | 6 | 6 | |
| | Z(-40°C)/Z(20°C) | 6 | 6 | 6 | 6 | 6 | - | |
| Load Life | The following specifications shall be satisfied when the capacitors are restored to 20°C after subjected to DC voltage with the rated ripple current is applied for 10,000 hours (∅D≤10: 8000hrs) at 105°C. | | | | | | | |
| | Capacitance Change | Within ± 20% of Initial Value | | | | | | |
| | tan δ | 200% or less of Initial Specified Value | | | | | | |
| | Leakage Current | Initial Specified Value or less | | | | | | |
| Shelf Life | The following specifications shall be satisfied when the capacitors are restored to 20°C after exposing them for 1,000 hours 105°C without voltage applied. Before the measurement, the capacitor shall be preconditioned by applying voltage according to them 4.1 of JIS C5101-4. | | | | | | | |
| | Capacitance Change | Within ± 20% of Initial Value | | | | | | |
| | tan δ | 200% or less of Initial Specified Value | | | | | | |
| | Leakage Current | Initial Specified Value or less | | | | | | |
| Standards | JIS C-5101-4(IEC 60384) | | | | | | | |

Frequency Coefficient of Permissible Ripple Current

| Capacitance (µF) | Frequency (Hz) | | | | |
|------------------|----------------|------|------|------|------|
| | 50 | 120 | 1K | 10K | 100K |
| 1~5.6 | 0.65 | 1 | 1.25 | 1.5 | 2.0 |
| 6.8 ~ 82 | 0.70 | 1.00 | 1.75 | 2.25 | 2.50 |
| 100 ~ 330 | 0.75 | 1.00 | 1.67 | 2.05 | 2.25 |

The endurance of capacitors is reduced with internal heating produced by ripple current at the rate of halving the lifetime with every 5°C rise. When long life performance is required in actual use, the rms ripple current has to be reduced.

RHC Series

Dimensions (mm)

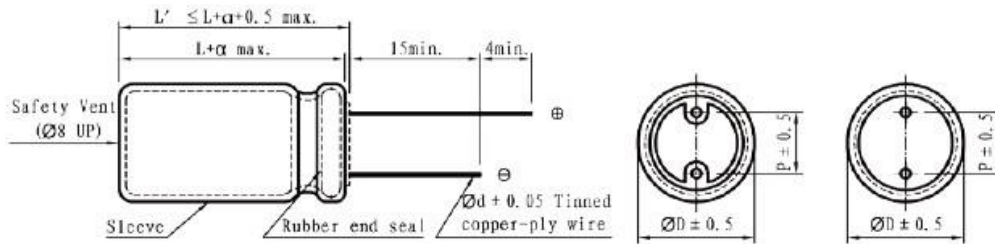

| | | | | | | |
|----|-----|-----|-----|------|-----|-----|
| ØD | 8 | 10 | 13 | 14.5 | 16 | 18 |
| P | 3.5 | 5.0 | 5.0 | 7.5 | 7.5 | 7.5 |
| Ød | 0.5 | 0.6 | 0.6 | 0.8 | 0.8 | 0.8 |

| | |
|----------|--------------|
| α | (L < 16) 1.0 |
| | (L ≥ 16) 2.0 |

Standard Ratings

D×L(mm) ; R.C.(mA rms) at 105°C 120Hz.

| Cap (µF) | V | 160 | | | 200 | | | 250 | | |
|-------------|---|-------|-------|--------|-------|-------|--------|-------|-------|--------|
| | | D x L | R.C. | | D x L | R.C. | | D x L | R.C. | |
| | | | 120Hz | 100KHZ | | 120Hz | 100KHZ | | 120Hz | 100KHZ |
| 10 | | 10x16 | 125 | 313 | 10x16 | 125 | 313 | 10x20 | 140 | 350 |
| 22 | | 10x20 | 200 | 500 | 10x20 | 200 | 500 | 10x20 | 200 | 500 |
| 33 | | 10x20 | 250 | 625 | 10x20 | 260 | 650 | 13x21 | 320 | 800 |
| 47 | | 10x20 | 300 | 750 | 13x21 | 390 | 975 | 13x21 | 390 | 975 |
| 68 | | 13x21 | 470 | 1175 | 13x21 | 470 | 1175 | 16x22 | 520 | 1300 |
| 82 | | 13x21 | 510 | 1275 | 16x22 | 550 | 1375 | 16x22 | 550 | 1375 |
| 100 | | 13x25 | 620 | 1395 | 16x22 | 630 | 1418 | 16x26 | 680 | 1530 |
| | | 16x22 | 630 | 1418 | | | | | | |
| 150 | | 16x22 | 770 | 1733 | 16x26 | 840 | 1890 | 18x25 | 860 | 1935 |
| 220 | | 18x25 | 1020 | 2295 | 18x26 | 1050 | 2363 | 18x32 | 1130 | 2543 |
| 330 | | 18x32 | 1390 | 3128 | 18x36 | 1430 | 3218 | | | |

| Ca p (µF) | V | 350 | | | 400 | | | 450 | | |
|-----------------|-------|-------|-------|--------|-------|-------|--------|-------|-------|--------|
| | | D x L | R.C. | | D x L | R.C. | | D x L | R.C. | |
| | | | 120Hz | 100KHZ | | 120Hz | 100KHZ | | 120Hz | 100KHZ |
| 6.8 | | 10x16 | 110 | 275 | 10x16 | 110 | 275 | 10x20 | 110 | 275 |
| 10 | | 10x20 | 140 | 350 | 10x20 | 140 | 350 | 13x21 | 180 | 450 |
| 22 | | 13x21 | 260 | 650 | 13x21 | 260 | 650 | 16x22 | 290 | 725 |
| 33 | | 16x22 | 360 | 900 | 16x22 | 360 | 900 | 16x26 | 390 | 975 |
| | 18x22 | | | | | | | 380 | 950 | |
| 47 | | 16x22 | 430 | 1075 | 16x25 | 470 | 1175 | 18x25 | 480 | 1200 |
| | 18x22 | | | | 450 | 1125 | | | | |
| 68 | | 16x26 | 560 | 1400 | 18x25 | 585 | 1463 | 18x32 | 630 | 1575 |
| | | 18x22 | 550 | 1375 | | | | | | |
| 82 | | 18x25 | 610 | 1525 | 18x25 | 610 | 1525 | 18x35 | 715 | 1788 |
| 100 | | 18x25 | 700 | 1575 | 18x32 | 765 | 1721 | 18x40 | 800 | 1800 |
| 120 | | 18x32 | 830 | 1868 | 18x35 | 865 | 1946 | | | |
| 150 | | 18x35 | 960 | 2160 | 18x40 | 985 | 2216 | | | |

※ 13mm may be replaced by 12.5mm upon customer's request.

RHC Series

SLIM TYPE

- 105°C high-temperature and high voltage 350 ~450V,
- Life 8000~10000hrs
- Specially Size, 8~16mm diameter.
- For LCD-TV and LCD-Monitor power.
- RoHS Compliant.

Standard Ratings

DxL(mm) ; R.C.(mA rms) at 105°C 120Hz.

| Cap (μF) | V | 350 | | | 400 | | | 450 | | |
|-------------|------|---------|-------|--------|---------|-------|--------|---------|-------|--------|
| | | D x L | R.C. | | D x L | R.C. | | D x L | R.C. | |
| | | | 120Hz | 100KHZ | | 120Hz | 100KHZ | | 120Hz | 100KHZ |
| 22 | Item | 10x30 | 212 | 530 | 8x50 | 236 | 590 | 8x50 | 254 | 635 |
| | | | | | 10x35 | 260 | 650 | 10x40 | 280 | 700 |
| 33 | Item | 8x50 | 240 | 600 | 8x61 | 280 | 700 | 8x61 | 280 | 700 |
| | | | | | 10x40 | 312 | 780 | 10x45 | 332 | 830 |
| | | 10x35 | 260 | 650 | 13x30 | 336 | 840 | 13x40 | 360 | 900 |
| 39 | Item | 10x40 | 280 | 700 | 10x50 | 380 | 950 | 10x50 | 420 | 1050 |
| | | | | | 13x35 | 368 | 920 | 13x45 | 408 | 1020 |
| 47 | Item | 10x50 | 380 | 950 | 10x60 | 480 | 1200 | 10x60 | 520 | 1300 |
| | | 13x35 | 400 | 1000 | 13x40 | 460 | 1150 | 13x50 | 560 | 1400 |
| | | 14.5x30 | 400 | 1000 | 14.5x35 | 440 | 1100 | 14.5x45 | 512 | 1280 |
| 53 | Item | 10x50 | 440 | 1100 | 10x60 | 480 | 1200 | 13x50 | 600 | 1500 |
| | | 13x40 | 480 | 1200 | 13x45 | 500 | 1250 | 14.5x45 | 512 | 1280 |
| | | 14.5x30 | 400 | 1000 | 14.5x35 | 440 | 1100 | 16x35 | 560 | 1400 |
| 68 | Item | 10x60 | 520 | 1300 | 13x50 | 540 | 1350 | 13x60 | 660 | 1650 |
| | | 13x45 | 480 | 1200 | | | | 14.5x50 | 680 | 1700 |
| | | 14.5x35 | 440 | 1100 | 14.5x45 | 600 | 1500 | 16x40 | 628 | 1570 |
| 82 | Item | 13x50 | 540 | 1350 | 13x60 | 600 | 1500 | 13x60 | 700 | 1750 |
| | | | | | 14.5x50 | 648 | 1620 | 14.5x50 | 720 | 1800 |
| | | 14.5x40 | 588 | 1470 | 16x40 | 648 | 1620 | 16x45 | 792 | 1980 |
| 100 | Item | 13x60 | 660 | 1485 | 14.5x50 | 770 | 1733 | 14.5x60 | 855 | 1924 |
| | | 14.5x45 | 682 | 1534 | 16x50 | 902 | 2030 | 16x50 | 990 | 2228 |

※ 13mm may be replaced by 12.5mm upon customer's request.

RHD Series

- High temperature resistance, high reliability
- 125°C, 2000 hours long life product
- RoHS Compliant & Halogen Free

Specifications

| Items | Characteristics | | | | | | | | | | | | | | | |
|--|---|---|------|------|------|------|------|------|---|------|------|---------|------|------|---------|------|
| Capacitance Tolerance | ± 20% (120Hz, 20°C) | | | | | | | | | | | | | | | |
| Operating Temperature Range | -40 ~ +125°C | | | | | | | | -40 ~ +125°C | | | | | | | |
| Rated Voltage Range | 10 ~ 100VDC | | | | | | | | 160 ~ 250VDC | | | | | | | |
| Leakage Current | I ≤ 0.01CV or 3 (μA) which is greater. (After 2 minutes application of DC rated voltage, at 20 °C) | | | | | | | | I ≤ 0.03CV +20 (μA) (After 3 minutes application of DC rated voltage, at 20 °C) | | | | | | | |
| Dissipation Factor | Measurement Frequency: 120Hz. Temperature: 20°C | | | | | | | | | | | | | | | |
| | Rated Voltage (V) | 6.3 | 10 | 16 | 25 | 35 | 50 | 63 | 80 | 100 | 160 | 200 | 250 | 275 | 350~450 | 500 |
| | tan δ(Max) | 0.24 | 0.20 | 0.16 | 0.14 | 0.12 | 0.10 | 0.10 | 0.10 | 0.10 | 0.15 | 0.20 | 0.20 | 0.20 | 0.24 | 0.24 |
| When nominal capacitance over 1000μF, tan δ shall be added 0.02 to the listed value with increase of every 1000μF. | | | | | | | | | | | | | | | | |
| Low Temperature Stability | Measurement Frequency: 120Hz. | | | | | | | | | | | | | | | |
| | Rated Voltage(V) | 10 | 16 | 25 | 35 | 50 | 63 | 100 | 160 | 200 | 250 | 350~450 | | | | |
| | Z(-25°C) / Z(20°C) | 3 | 2 | 2 | 2 | 2 | 2 | 3 | 3 | 3 | 3 | 6 | | | | |
| Impedance Ratio (Max) | Z(-40°C) / Z(20°C) | 8 | 6 | 4 | 4 | 4 | 4 | 4 | 6 | 6 | 6 | - | | | | |
| | 2000hours, with application of rated voltage at 125°C | | | | | | | | | | | | | | | |
| Load Life | Capacitance | Within ± 25% of Initial Value | | | | | | | | | | | | | | |
| | tan δ | 200% or less of Initial Specified Value | | | | | | | | | | | | | | |
| | Leakage Current | Initial Specified Value or less | | | | | | | | | | | | | | |
| Shelf Life | The following specifications shall be satisfied when the capacitors are restored to 20°C after exposing them for 1,000 hours 125°C without voltage applied. Before the measurement, the capacitor shall be preconditioned by applying voltage according to them 4.1 of JIS C5101-4. | | | | | | | | | | | | | | | |
| | Capacitance | Within ± 25% of Initial Value | | | | | | | | | | | | | | |
| | tan δ | 200% or less of Initial Specified Value | | | | | | | | | | | | | | |
| | Leakage Current | Initial Specified Value or less | | | | | | | | | | | | | | |
| Standards | JIS C-5101-4(IEC 60384) | | | | | | | | | | | | | | | |

Frequency Coefficient of Permissible Ripple Current

| Rated Voltage (V) | Capacitance (μF) | Frequency (Hz) | | | |
|-------------------|------------------|----------------|------|------|-------|
| | | 50 | 120 | 1K | ≥ 10K |
| ≦ 100 | < 100 | 0.75 | 1.00 | 1.57 | 2.00 |
| | 100 ~ 470 | 0.80 | 1.00 | 1.34 | 1.50 |
| | > 470 | 0.85 | 1.00 | 1.10 | 1.15 |
| ≧ 160 | 1 ~ 100 | 0.85 | 1.00 | 1.40 | 1.50 |

The endurance of capacitors is reduced with internal heating produced by ripple current at the rate of halving the lifetime with every 5°C rise. When long life performance is required in actual use, the rms ripple current has to be reduced.

RHD Series

Dimensions (mm)

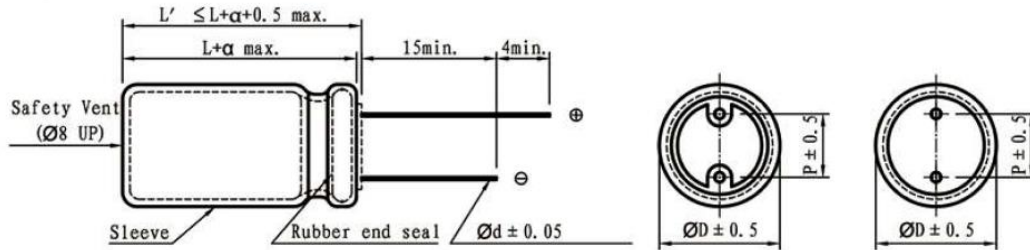

| | | | | | |
|----|-----|-----|-----|-----|-----|
| ØD | 6.3 | 8 | 10 | 13 | 16 |
| P | 2.5 | 3.5 | 5.0 | 5.0 | 7.5 |
| Ød | 0.5 | 0.5 | 0.6 | 0.6 | 0.8 |

| | |
|----------|--------------|
| α | (L < 16) 1.0 |
| | (L ≥ 16) 2.0 |

Standard Ratings

D×L(mm) ; R.C.(mA rms) at 125°C 120Hz.

| Cap (µF) | V | 10 | | 16 | | 25 | | 35 | | 50 | | 63 | |
|----------|---|--------|-------|--------|-------|--------|-------|--------|-------|-------|-------|-------|-------|
| | | Item | D x L | R.C. | D x L | R.C. | D x L | R.C. | D x L | R.C. | D x L | R.C. | D x L |
| 3.3 | | | | | | | | | | | | 8x12 | 28 |
| 4.7 | | | | | | | | | | | | 8x12 | 35 |
| 10 | | | | | | | | 6.3x11 | 40 | 8x12 | 45 | 8x12 | 54 |
| 22 | | | | | | 6.3x11 | 70 | 8x12 | 78 | 8x12 | 80 | 10x13 | 92 |
| 33 | | | | 6.3x11 | 70 | 8x12 | 90 | 8x12 | 105 | 8x12 | 112 | 10x16 | 130 |
| 47 | | 6.3x11 | 80 | 6.3x11 | 82 | 8x12 | 110 | 8x12 | 148 | 10x13 | 154 | 10x20 | 170 |
| 100 | | 6.3x11 | 105 | 8x12 | 146 | 8x12 | 220 | 10x13 | 252 | 10x16 | 267 | 13x21 | 285 |
| 220 | | 8x12 | 230 | 10x13 | 300 | 10x13 | 450 | 10x16 | 530 | 13x21 | 568 | 13x25 | 585 |
| 330 | | 10x13 | 310 | 10x13 | 385 | 10x16 | 620 | 10x20 | 710 | 13x25 | 880 | 16x26 | 950 |
| 470 | | 10x13 | 420 | 10x16 | 520 | 10x20 | 800 | 13x21 | 890 | 16x26 | 900 | | |
| 1000 | | 10x20 | 760 | 13x21 | 800 | 13x25 | 900 | 16x26 | 1100 | | | | |

| Cap (µF) | V | 100 | | 160 | | 200 | | 250 | | 350 | | 400 | | 450 | |
|----------|---|-------|-------|-------|-------|-------|-------|-------|-------|-------|-------|-------|-------|-------|-------|
| | | Item | D x L | R.C. | D x L | R.C. | D x L | R.C. | D x L | R.C. | D x L | R.C. | D x L | R.C. | D x L |
| 0.47 | | 8x12 | 15 | | | | | | | | | | | | |
| 1 | | 8x12 | 22 | 8x12 | 28 | 8x12 | 28 | 8x12 | 40 | 8x12 | 40 | 8x12 | 42 | 8x12 | 45 |
| 2.2 | | 8x12 | 30 | 8x12 | 35 | 8x12 | 35 | 10x13 | 48 | 10x13 | 48 | 10x13 | 48 | 10x16 | 52 |
| 3.3 | | 8x12 | 35 | 10x13 | 40 | 10x16 | 45 | 10x16 | 50 | 10x16 | 50 | 10x16 | 53 | 10x20 | 58 |
| 4.7 | | 10x13 | 42 | 10x13 | 50 | 10x16 | 60 | 10x20 | 65 | 10x20 | 53 | 10x20 | 62 | 10x25 | 65 |
| 10 | | 10x16 | 68 | 10x16 | 80 | 10x20 | 78 | 10x20 | 78 | 10x25 | 85 | 10x25 | 86 | 13x21 | 90 |
| 22 | | 10x20 | 95 | 10x20 | 115 | 10x25 | 126 | 13x21 | 128 | 13x25 | 139 | 13x30 | 142 | 16x26 | 154 |
| 33 | | 13x21 | 150 | 10x25 | 154 | 13x21 | 157 | 13x25 | 171 | 16x26 | 189 | 16x26 | 189 | 16x32 | 203 |
| 47 | | 13x25 | 180 | 13x25 | 200 | 13x25 | 204 | 16x26 | 292 | 16x32 | 243 | 16x32 | 243 | | |
| 68 | | 13x25 | 210 | 16x26 | 245 | 16x26 | 250 | 16x32 | 292 | | | | | | |
| 100 | | 16x26 | 290 | 16x32 | 360 | 16x36 | 329 | | | | | | | | |

※ 13mm may be replaced by 12.5mm upon customer's request.

Aluminum Electrolytic Capacitors

RHI Series

- Miniature RHC series, long-life products.
- Load life: 10000~12000hours.
- Suitable for electronic ballast for lighting equipment,
- Long-life power input with smooth function.
- RoHS Compliant & Halogen Free

Specifications

| Items | Characteristics | | | | | | |
|--|---|---|------|--------------|------|------|------|
| Capacitance Tolerance | ± 20% (120Hz, 20°C) | | | | | | |
| Operating Temperature Range | -40 ~ +105°C | | | -25 ~ +105°C | | | |
| Rated Voltage Range | 16 ~ 400VDC | | | 450VDC | | | |
| Leakage Current | $I \leq 0.04CV+100\mu A$ which is greater. (After 1minutes application of DC rated voltage, at 20 °C) | | | | | | |
| Dissipation Factor | Measurement Frequency: 120Hz. Temperature: 20°C | | | | | | |
| | Rated Voltage (V) | 160 | 200 | 250 | 350 | 400 | 450 |
| | tan δ(Max) | 0.20 | 0.20 | 0.20 | 0.24 | 0.24 | 0.24 |
| When nominal capacitance over 1000μF, tanδ shall be added 0.02 to the listed value with increase of every 1000μF | | | | | | | |
| Low Temperature Stability | Measurement Frequency: 120Hz. | | | | | | |
| | Rated Voltage(V) | 160 | 200 | 250 | 350 | 400 | 450 |
| | Z(-25°C)/Z(20°C) | 3 | 3 | 3 | 5 | 5 | 6 |
| Impedance Ratio (Max) | Z(-40°C)/Z(20°C) | 8 | 8 | 8 | 10 | 10 | - |
| | 12,000 hours, with application of rated voltage at 105°C.(L≤20mm,10,000hrs) | | | | | | |
| | Capacitance Change | Within ± 20% of Initial Value | | | | | |
| Load Life | tan δ | 200% or less of Initial Specified Value | | | | | |
| | Leakage Current | Initial Specified Value or less | | | | | |
| | The following specifications shall be satisfied when the capacitors are restored to 20°C after exposing them for 1,000 hours 105°C without voltage applied. Before the measurement, the capacitor shall be preconditioned by applying voltage according to them 4.1 of JIS C5101-4. | | | | | | |
| Shelf Life | Capacitance Change | Within ± 20% of Initial Value | | | | | |
| | tan δ | 200% or less of Initial Specified Value | | | | | |
| | Leakage Current | Initial Specified Value or less | | | | | |
| Standards | JIS C-5101-4(IEC 60384) | | | | | | |

Frequency Coefficient of Permissible Ripple Current

| Capacitance (μF) | Frequency (Hz) | | | |
|------------------|----------------|------|------|------|
| | 120 | 1K | 10K | 100K |
| 6.8~82 | 1.00 | 1.75 | 2.25 | 2.50 |
| 100~680 | 1.00 | 1.67 | 2.05 | 2.25 |

The endurance of capacitors is reduced with internal heating produced by ripple current at the rate of halving the lifetime with every 5°C rise. When long life performance is required in actual use, the rms ripple current has to be reduced.

Dimensions (mm)

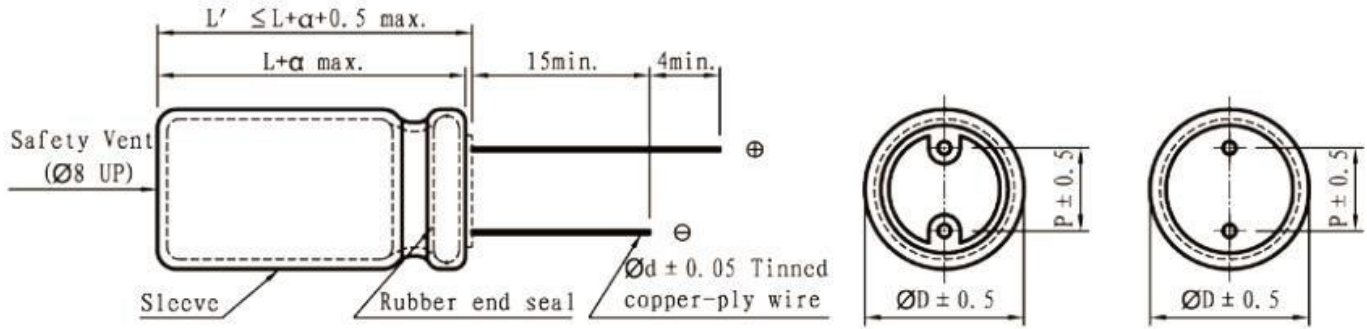

| | | | | |
|--------------|-----|-----|-----|-----|
| $\text{Ø} D$ | 10 | 13 | 16 | 18 |
| P | 5.0 | 5.0 | 7.5 | 7.5 |
| $\text{Ø} d$ | 0.6 | 0.6 | 0.8 | 0.8 |

| | |
|----------|------------------|
| α | ($L < 16$) 1.0 |
| | ($L > 16$) 2.0 |

Standard Ratings

DxL(mm) ; R.C.(mA rms) at 105°C 120Hz.

| Cap (μF) | V Item | 160 | | 200 | | 250 | | 350 | | 400 | | 450 | |
|--------------------------|-----------|-------|------|-------|------|-------|------|-------|------|-------|------|-------|------|
| | | D x L | R.C. | D x L | R.C. | D x L | R.C. | D x L | R.C. | D x L | R.C. | D x L | R.C. |
| 6.8 | | | | | | | | | | 10x16 | 130 | 10x16 | 100 |
| 10 | | | | | | | | | | 10x16 | 140 | 10x20 | 130 |
| 12 | | | | | | | | 10x16 | 150 | 10x20 | 165 | 10x20 | 145 |
| 15 | | | | | | | | 10x20 | 170 | 10x20 | 180 | 10x25 | 175 |
| 22 | | | | 10x16 | 210 | 10x16 | 210 | 10x20 | 215 | 10x30 | 260 | 13x25 | 285 |
| 33 | | 10x16 | 230 | 10x20 | 290 | 10x20 | 290 | 13x21 | 330 | 13x25 | 365 | 16x22 | 365 |
| 47 | | 10x20 | 285 | 10x20 | 340 | 13x21 | 465 | 13x25 | 485 | 16x22 | 495 | 16x26 | 475 |
| 56 | | 10x20 | 300 | 10x25 | 395 | 13x21 | 490 | 16x22 | 530 | 16x26 | 555 | 18x26 | 530 |
| 68 | | 13x21 | 500 | 13x21 | 520 | 13x25 | 550 | 16x26 | 630 | 16x26 | 600 | 16x36 | 625 |
| 82 | | 13x21 | 580 | 13x25 | 610 | 16x22 | 655 | 18x26 | 720 | 18x26 | 720 | 18x32 | 695 |
| 100 | | 13x21 | 610 | 16x22 | 655 | 16x22 | 680 | 18x26 | 750 | 18x32 | 830 | 18x35 | 790 |
| 120 | | 16x22 | 720 | 16x22 | 760 | 16x26 | 800 | 18x32 | 890 | 18x35 | 890 | 18x40 | 885 |
| 150 | | 16x22 | 780 | 18x22 | 865 | 18x26 | 920 | 18x35 | 1020 | 18x40 | 980 | | |
| 180 | | 16x25 | 950 | 18x22 | 950 | 18x30 | 990 | 18x40 | 1140 | 18x45 | 1050 | | |
| 220 | | 18x25 | 1050 | 18x26 | 1125 | 18x32 | 1100 | 18x45 | 1235 | | | | |
| 270 | | 18x30 | 1170 | 18x32 | 1340 | 18x40 | 1380 | | | | | | |
| 330 | | 18x35 | 1370 | 18x32 | 1480 | 18x45 | 1450 | | | | | | |
| 390 | | 18x36 | 1500 | 18x35 | 1590 | | | | | | | | |
| 470 | | 18x40 | 1825 | 18x40 | 1760 | | | | | | | | |
| 560 | | 18x45 | 2025 | | | | | | | | | | |
| 680 | | 18x50 | 2185 | | | | | | | | | | |

※ 13mm may be replaced by 12.5mm upon customer's request.

Aluminum Electrolytic Capacitors

RHD Series

- High temperature resistance, high reliability.
- 125°C, 2000 hours long life product.
- RoHS Compliant

Specifications

| Items | Characteristics | | | | | | | | | | | |
|---|---|---|------|------|--------------|------|--|------|--------------|------|------|---------|
| Capacitance Tolerance | ± 20%(120Hz, 20°C) | | | | | | | | | | | |
| Operating Temperature Range | -40 ~ +125°C | | | | -40 ~ +125°C | | | | -25 ~ +125°C | | | |
| Rated Voltage Range | 10 ~ 100VDC | | | | 160 ~ 250VDC | | | | 350 ~ 450VDC | | | |
| Leakage Current | $I \leq 0.01CV$ or 2 (μA) which is greater (After 2 minutes application of DC rated voltage, at 20°C) | | | | | | $I \leq 0.03CV + 20$ (μA) (After 3 minutes application of DC rated voltage, at 20°C) | | | | | |
| Dissipation Factor (tan δ) | Measurement Frequency: 120Hz. Temperature: 20°C | | | | | | | | | | | |
| | Rated Voltage(V) | 10 | 16 | 25 | 35 | 50 | 63 | 100 | 160 | 200 | 250 | 350~450 |
| | tan δ(Max) | 0.20 | 0.16 | 0.14 | 0.12 | 0.10 | 0.10 | 0.10 | 0.15 | 0.20 | 0.20 | 0.24 |
| | When nominal capacitance over 1000μF, tanδ shall be added 0.02 to the listed value with increase of every 1000μF. | | | | | | | | | | | |
| Low Temperature Stability Impedance Ratio (Max) | Measurement Frequency: 120Hz. | | | | | | | | | | | |
| | Rated Voltage(V) | 10 | 16 | 25 | 35 | 50 | 63 | 100 | 160 | 200 | 250 | 350~450 |
| | Z(-25°C)/Z(20°C) | 3 | 2 | 2 | 2 | 2 | 2 | 3 | 3 | 3 | 3 | 6 |
| | Z(-40°C)/Z(20°C) | 8 | 6 | 4 | 4 | 4 | 4 | 4 | 6 | 6 | 6 | - |
| Load Life | 2000 hours, with application of rated voltage at 125°C | | | | | | | | | | | |
| | Capacitance Change | Within ± 25% of Initial Value | | | | | | | | | | |
| | tan δ | 200% or less of Initial Specified Value | | | | | | | | | | |
| | Leakage Current | Initial Specified Value or less | | | | | | | | | | |
| Shelf Life | The following specifications shall be satisfied when the capacitors are restored to 20°C after exposing them for 1,000 hours 125°C without voltage applied. Before the measurement, the capacitor shall be preconditioned by applying voltage according to them 4.1 of JIS C5101-4. | | | | | | | | | | | |
| | Capacitance Change | Within ± 25% of Initial Value | | | | | | | | | | |
| | tan δ | 200% or less of Initial Specified Value | | | | | | | | | | |
| | Leakage Current | Initial Specified Value or less | | | | | | | | | | |
| Standards | JIS C 5101-4 (IEC 60384) | | | | | | | | | | | |

Frequency Coefficient of Permissible Ripple Current

| Rated Voltage (V) | Capacitance (μF) | Frequency (Hz) | | | |
|-------------------|------------------|----------------|------|------|------|
| | | 50 | 120 | 1K | ≥10K |
| ≦100 | <100 | 0.75 | 1.00 | 1.57 | 2.00 |
| | 100 ~ 470 | 0.80 | 1.00 | 1.34 | 1.50 |
| | >470 | 0.85 | 1.00 | 1.10 | 1.15 |
| ≦160 | 1 ~ 100 | 0.85 | 1.00 | 1.40 | 1.50 |

The endurance of capacitors is reduced with internal heating produced by ripple current at the rate of halving the lifetime with every 5°C rise. When long life performance is required in actual use, the rms ripple current has to be reduced.

Aluminum Electrolytic Capacitors

RHD Series

Dimensions (mm)

| | | | | | |
|-----|-----|-----|-----|-----|-----|
| Ø D | 6.3 | 8 | 10 | 13 | 16 |
| P | 2.5 | 3.5 | 5.0 | 5.0 | 7.5 |
| Ø d | 0.5 | 0.5 | 0.6 | 0.6 | 0.8 |

| | |
|----------|--------------|
| α | (L < 16) 1.0 |
| | (L ≥ 16) 2.0 |

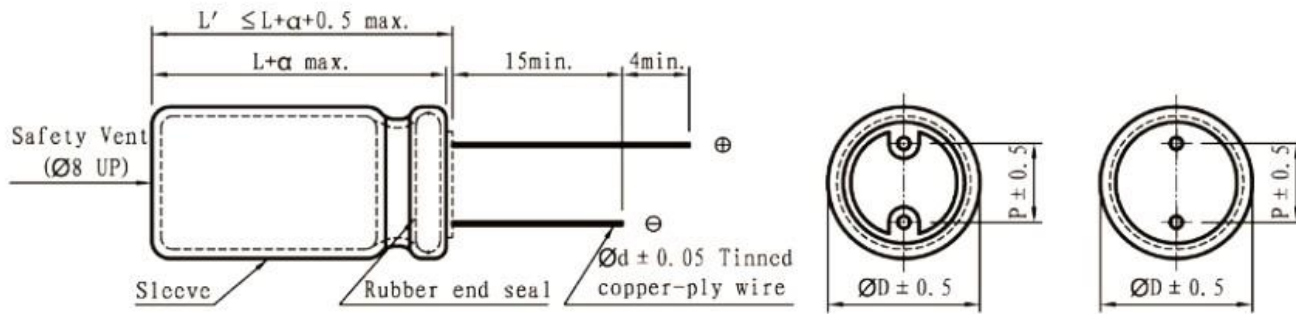

Standard Ratings

DxL(mm) ; R.C.(mA rms) at 125°C 120Hz.

| Cap(µF) | V | 10 | | 16 | | 25 | | 35 | | 50 | | 63 | | | |
|---------|------|--------|------|--------|------|--------|------|--------|------|-------|------|-------|------|-------|------|
| | Item | D x L | R.C. | D x L | R.C. | D x L | R.C. | D x L | R.C. | D x L | R.C. | D x L | R.C. | | |
| 3.3 | | | | | | | | | | | | 8x12 | 28 | | |
| 4.7 | | | | | | | | | | | | 8x12 | 35 | | |
| 10 | | | | | | | | 6.3x11 | 40 | 8x12 | 45 | 8x12 | 54 | | |
| 22 | | | | | | 6.3x11 | 70 | 8x12 | 78 | 8x12 | 80 | 10x13 | 92 | | |
| 33 | | | | 6.3x11 | 70 | 8x12 | 90 | 8x12 | 105 | 8x12 | 112 | 10x16 | 130 | | |
| 47 | | 6.3x11 | 80 | 6.3x11 | 82 | 8x12 | 110 | 8x12 | 148 | 10x13 | 154 | 10x20 | 170 | | |
| 100 | | 6.3x11 | 105 | 8x12 | 146 | 8x12 | 220 | 10x13 | 252 | 10x16 | 267 | 13x21 | 285 | | |
| 220 | | 8x12 | 230 | 10x13 | 300 | 10x13 | 450 | 10x16 | 530 | 13x21 | 568 | 13x25 | 585 | | |
| 330 | | 10x13 | 310 | 10x13 | 385 | 10x16 | 620 | 10x20 | 710 | 13x25 | 880 | 16x26 | 950 | | |
| 470 | | 10x13 | 420 | 10x16 | 520 | 10x20 | 800 | 13x21 | 890 | 16x26 | 900 | | | | |
| 1000 | | 10x20 | 760 | 13x21 | 800 | 13x25 | 900 | 16x26 | 1100 | | | | | | |
| Cap(µF) | V | 100 | | 160 | | 200 | | 250 | | 350 | | 400 | | 450 | |
| | Item | D x L | R.C. | D x L | R.C. | D x L | R.C. | D x L | R.C. | D x L | R.C. | D x L | R.C. | D x L | R.C. |
| 0.47 | | 8x12 | 15 | | | | | | | | | | | | |
| 1 | | 8x12 | 22 | 8x12 | 28 | 8x12 | 28 | 8x12 | 40 | 8x12 | 40 | 8x12 | 42 | 8x12 | 45 |
| 2.2 | | 8x12 | 30 | 8x12 | 35 | 8x12 | 35 | 10x13 | 48 | 10x13 | 48 | 10x13 | 48 | 10x16 | 52 |
| 3.3 | | 8x12 | 35 | 10x13 | 40 | 10x1 | 45 | 10x16 | 50 | 10x16 | 50 | 10x16 | 53 | 10x20 | 58 |
| 4.7 | | 10x13 | 42 | 10x13 | 50 | 10x1 | 60 | 10x20 | 65 | 10x20 | 53 | 10x20 | 62 | 10x25 | 65 |
| 10 | | 10x16 | 68 | 10x16 | 80 | 10x2 | 78 | 10x20 | 78 | 10x25 | 85 | 10x25 | 86 | 13x21 | 90 |
| 22 | | 10x20 | 95 | 10x20 | 115 | 10x2 | 126 | 13x21 | 128 | 13x25 | 139 | 13x30 | 142 | 16x26 | 154 |
| 33 | | 13x21 | 150 | 10x25 | 154 | 13x2 | 157 | 13x25 | 171 | 16x26 | 189 | 16x26 | 189 | 16x32 | 203 |
| 47 | | 13x25 | 180 | 13x25 | 200 | 13x2 | 204 | 16x26 | 292 | 16x32 | 243 | 16x32 | 243 | | |
| 68 | | 13x25 | 210 | 16x26 | 245 | 16x2 | 250 | 16x32 | 292 | | | | | | |
| 100 | | 16x26 | 290 | 16x32 | 360 | 16x3 | 329 | | | | | | | | |

※ 13mm may be replaced by 12.5mm upon customer's request.

Aluminum Electrolytic Capacitors

RHJ Series

- High temperature, high ripple current at high frequency.
- Specially designed for electronic ballast and energy saving lamp.
- Load Life: 2,000~3,000 hours.
- RoHS Compliance

Specifications

| Items | Characteristics | | | | | | | | | | | |
|---|--|---|------|------|------|------|---|------|------|---------------|------|-----------|
| Capacitance Tolerance | ± 20%(120Hz,20°C) | | | | | | | | | | | |
| Operating Temperature Range | - 40 ~ +130°C | | | | | | - 40 ~ +130°C | | | - 25 ~ +130°C | | |
| Rated Voltage Range | 10 ~ 100VDC | | | | | | 160 ~ 250VDC | | | 350 ~ 450VDC | | |
| Leakage Current | I ≤ 0.01CV or 3 (μA) which is greater. (After 2 minutes application of DC rated voltage, at 20 °C) | | | | | | I ≤ 0.03CV +20 (μA) (After 3 minutes application of DC rated voltage, at 20 °C) | | | | | |
| Leakage Current (tan δ) | Measurement Frequency:120Hz. Temperature: 20°C | | | | | | | | | | | |
| | Rated Voltage(V) | 10 | 16 | 25 | 35 | 50 | 63 | 100 | 160 | 200 | 250 | 350 ~ 450 |
| | Tan δ (Max) | 0.20 | 0.16 | 0.14 | 0.12 | 0.10 | 0.10 | 0.10 | 0.15 | 0.20 | 0.20 | 0.24 |
| | When nominal capacitance over 1000μF, tan δ shall be added 0.02 to the listed value with increase of every 1000μF. | | | | | | | | | | | |
| Low Temperature Stability Impedance Ratio (Max) | Measurement Frequency:120Hz | | | | | | | | | | | |
| | Rated Voltage(V) | 10 | 16 | 25 | 35 | 50 | 63 | 100 | 160 | 200 | 250 | 350 ~ 450 |
| | Z(-25°C) / Z(20°C) | 3 | 2 | 2 | 2 | 2 | 2 | 3 | 3 | 3 | 3 | 6 |
| Z(-40°C) / Z(20°C) | 8 | 6 | 4 | 4 | 4 | 4 | 4 | 6 | 6 | 6 | — | |
| Load Life | 3,000 hours, with application of rated voltage at 130°C. (∅D≤8mm,2,000hrs) | | | | | | | | | | | |
| | Capacitance Change | within ±25% of initial Value | | | | | | | | | | |
| | tan δ | 200% or less of initial Specified Value | | | | | | | | | | |
| | Leakage Current | Initial Specified Value or less | | | | | | | | | | |
| Shelf Life | The following specifications shall be satisfied when the capacitors are restored to 20°C after exposing them for 1,000hours 130°C without voltage applied. Before the measurement. The Capacitance shall be preconditioned by applying voltage according to them 4.1 of JIS C5101-4. | | | | | | | | | | | |
| | Capacitance Change | within ±25% of initial Value | | | | | | | | | | |
| | tan δ | 200% or less of initial Specified Value | | | | | | | | | | |
| | Leakage Current | Initial Specified Value or less | | | | | | | | | | |
| Standards | JIS C 5101-4 (IEC 60384) | | | | | | | | | | | |

Frequency Coefficient of Permissible Ripple Current

| Rated Voltage (V) | Capacitance (μF) | Frequency (Hz) | | | |
|-------------------|------------------|----------------|------|------|------|
| | | 50 | 120 | 1K | ≥10K |
| ≤100 | < 100 | 0.50 | 0.70 | 0.85 | 1.00 |
| | 100 ~ 1500 | 0.65 | 0.75 | 0.90 | 1.00 |
| | > 1500 | 0.75 | 0.80 | 0.95 | 1.00 |
| ≥160 | 1.8 ~ 5.6 | 0.20 | 0.40 | 0.80 | 1.00 |
| | 6.8 ~ 100 | 0.40 | 0.75 | 0.90 | 1.00 |

The endurance of capacitors is reduced with internal heating produced by ripple current at the rate of halving the lifetime with every 5°C rise. When long life performance is required in actual use, the rms ripple current has to be reduced.

RHJ Series

Dimensions (mm)

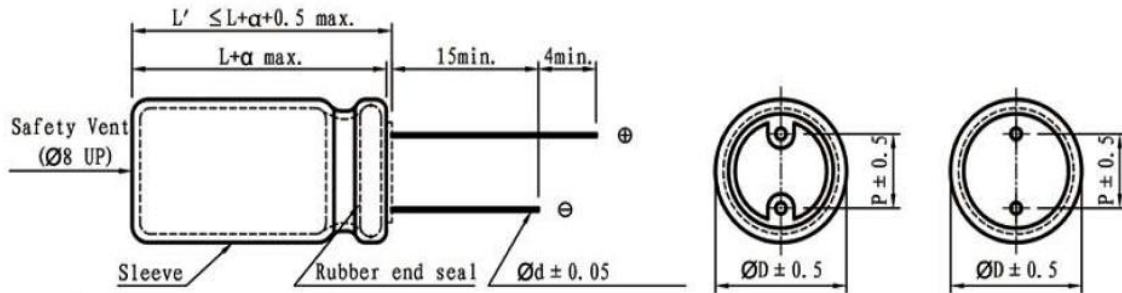

| | | | | |
|-----|-----|-----|-----|-----|
| Ø D | 8 | 10 | 13 | 16 |
| P | 3.5 | 5.0 | 5.0 | 7.5 |
| Ø d | 0.5 | 0.6 | 0.6 | 0.8 |

| | |
|---|--------------|
| α | (L < 16) 1.0 |
| | (L ≥ 16) 2.0 |

Standard Ratings

DxL(mm) ; R.C.(mA rms) at 130°C 100KHz.

| Cap (µF) | V | 10 | | 16 | | 25 | | 35 | | 50 | | 63 | | | |
|----------|---|-------|------|-------|------|-------|------|-------|------|-------|------|-------|------|-------|------|
| | | DxL | R.C. | DxL | R.C. | DxL | R.C. | DxL | R.C. | DxL | R.C. | DxL | R.C. | | |
| 3.3 | | | | | | | | | | 8x12 | 70 | | | | |
| 4.7 | | | | | | | | | | 8x12 | 100 | | | | |
| 10 | | | | | | | | | | 8x12 | 200 | 8x12 | 200 | | |
| 22 | | | | | | | | | | 8x12 | 260 | 8x12 | 250 | | |
| 33 | | | | | | | | | | 8x12 | 300 | 10x13 | 400 | | |
| 47 | | | | | | | | | | 8x12 | 300 | 10x16 | 450 | | |
| 100 | | 8x12 | 340 | 8x12 | 340 | 8x12 | 340 | 10x13 | 620 | 10x13 | 520 | 13x21 | 820 | | |
| 220 | | 8x12 | 340 | 10x13 | 620 | 10x13 | 620 | 10x16 | 800 | 10x20 | 890 | 13x25 | 1000 | | |
| 330 | | 10x13 | 580 | 10x13 | 620 | 10x16 | 800 | 10x20 | 960 | 13x21 | 1000 | 16x26 | 1500 | | |
| 470 | | 10x13 | 620 | 10x16 | 800 | 10x20 | 960 | 13x21 | 1430 | 13x25 | 1200 | 16x32 | 1850 | | |
| 1000 | | 10x20 | 960 | 13x21 | 1430 | 13x25 | 1430 | 16x26 | 1900 | 16x32 | 2180 | | | | |
| 2200 | | 13x25 | 1430 | 16x26 | 1900 | 16x32 | 2300 | 16x36 | 2550 | | | | | | |
| 3300 | | 16x26 | 1900 | 16x32 | 2300 | 16x36 | 2550 | | | | | | | | |
| 4700 | | 16x32 | 2300 | 16x36 | 2550 | | | | | | | | | | |
| Cap (µF) | V | 100 | | 160 | | 200 | | 250 | | 350 | | 400 | | 450 | |
| | | DxL | R.C. | DxL | R.C. | DxL | R.C. | DxL | R.C. | DxL | R.C. | DxL | R.C. | DxL | R.C. |
| 1.8 | | | | | | | | | | 10x16 | 62 | 10x16 | 60 | 10x16 | 58 |
| 2.2 | | | | | | | | | | 10x16 | 70 | 10x16 | 68 | 10x16 | 66 |
| 3.3 | | | | | | | | | | 10x16 | 84 | 10x16 | 82 | 10x16 | 80 |
| 4.7 | | 8x12 | 80 | 8x12 | 80 | 8x12 | 80 | 10x16 | 70 | 10x20 | 105 | 10x20 | 100 | 10x20 | 90 |
| 5.6 | | 8x12 | 118 | 8x12 | 100 | 8x16 | 118 | 10x16 | 130 | 10x20 | 150 | 13x21 | 160 | 13x21 | 150 |
| 6.8 | | 8x12 | 145 | 8x14 | 130 | 8x16 | 145 | 10x16 | 150 | 13x21 | 186 | 13x21 | 186 | 13x21 | 176 |
| 10 | | 8x12 | 200 | 10x16 | 200 | 10x16 | 200 | 10x20 | 224 | 13x21 | 278 | 13x21 | 278 | 16x26 | 510 |
| 22 | | 8x12 | 220 | 10x20 | 300 | 13x21 | 400 | 13x21 | 400 | 13x25 | 430 | 13x25 | 430 | 16x32 | 630 |
| 33 | | 10x13 | 260 | 13x21 | 400 | 13x21 | 480 | 13x25 | 510 | 16x26 | 600 | 16x26 | 600 | | |
| 47 | | 10x16 | 330 | 13x25 | 528 | 13x25 | 528 | 16x26 | 620 | 16x32 | 650 | 16x32 | 650 | | |
| 100 | | 13x21 | 670 | 16x26 | 716 | | | | | | | | | | |
| 220 | | 16x26 | 1100 | | | | | | | | | | | | |
| 330 | | 16x32 | 1300 | | | | | | | | | | | | |

※ 13mm may be replaced by 12.5mm upon customer's request.

Aluminum Electrolytic Capacitors

RHK Series

- On the basis of RHA series ripple promotion product.
- Suitable for LCD TV Power, SMPS.
- RoHS Compliant & Halogen Free

Specifications

| Items | Characteristics | | | | |
|---|---|---|--------------|------|------|
| Capacitance Tolerance | ± 20% (120Hz, 20°C) | | | | |
| Operating Temperature Range | -40 ~ +105°C | | -25 ~ +105°C | | |
| Rated Voltage Range | 400VDC | | 450 ~ 500VDC | | |
| Leakage Current | $I \leq 0.03CV + 20 (\mu A)$ (After 3 minutes application of DC rated voltage, at 20 °C) | | | | |
| Dissipation Factor | Measurement Frequency: 120Hz. Temperature: 20°C | | | | |
| | Rated Voltage (V) | 160~400 | 450 | 460 | 500 |
| | tan δ(Max) | 0.15 | 0.20 | 0.20 | 0.20 |
| When nominal capacitance over 1000μF, tanδ shall be added 0.02 to the listed value with increase of every 1000μF. | | | | | |
| Low Temperature Stability | Measurement Frequency: 120Hz. | | | | |
| | Rated Voltage(V) | 400 | 450 | 460 | 500 |
| | Z(-25°C) / Z(20°C) | 3 | 3 | 6 | 6 |
| Impedance Ratio (Max) | Z(-40°C) / Z(20°C) | 6 | - | - | - |
| | 5,000 hours, with application of rated voltage at 105°C. | | | | |
| Load Life | Capacitance Change | Within ± 20% of Initial Value | | | |
| | tan δ | 200% or less of Initial Specified Value | | | |
| | Leakage Current | Initial Specified Value or less | | | |
| Shelf Life | The following specifications shall be satisfied when the capacitors are restored to 20°C after exposing them for 1,000 hours 105°C without voltage applied. Before the measurement, the capacitor shall be preconditioned by applying voltage according to them 4.1 of JIS C5101-4. | | | | |
| | Capacitance Change | Within ± 20% of Initial Value | | | |
| | tan δ | 200% or less of Initial Specified Value | | | |
| | Leakage Current | Initial Specified Value or less | | | |
| Standards | JIS C 5101-4-1 (IEC 60384) | | | | |

Frequency Coefficient of Permissible Ripple Current

| Capacitance (μF) | Frequency (Hz) | | | | |
|------------------|----------------|------|------|------|------|
| | 120 | 1K | 10K | 50K | 100K |
| 10 ~ 82 | 1.00 | 1.75 | 2.25 | 2.35 | 2.50 |
| 100 ~ 150 | 1.00 | 1.67 | 2.05 | 2.15 | 2.25 |

The endurance of capacitors is reduced with internal heating produced by ripple current at the rate of halving the lifetime with every 5°C rise. When long life performance is required in actual use, the rms ripple current has to be reduced.

Aluminum Electrolytic Capacitors

RHK Series

Dimensions (mm)

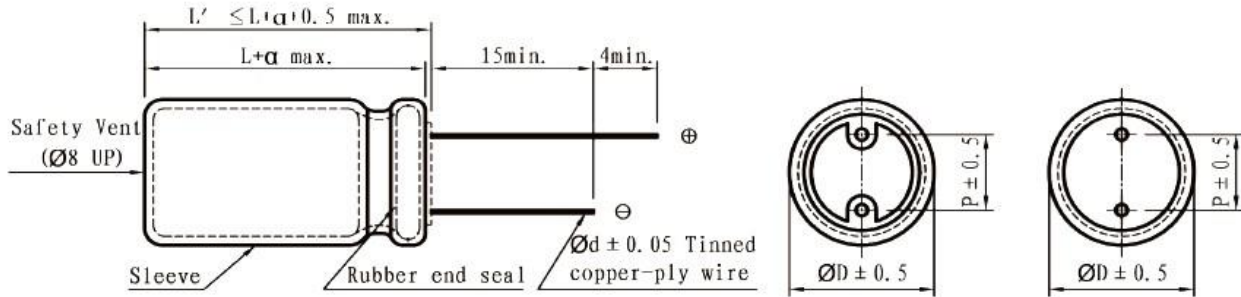

| | | | | | | |
|-----|-----|-----|-----|-----|-----|-----|
| Ø D | 10 | 13 | 16 | 18 | 20 | 22 |
| P | 5.0 | 5.0 | 7.5 | 7.5 | 10 | 10 |
| Ø d | 0.6 | 0.6 | 0.8 | 0.8 | 0.8 | 0.8 |

Standard Ratings

DxL(mm); R.C. (mA rms) at 105°C 120Hz.

| Cap (µF) | V | 400 | | | | 450 | | | | 460 | | | | 500 | | | |
|----------|---|-------|-------|-------|--------|-------|-------|--------|-------|-------|--------|-------|-------|--------|--|--|--|
| | | Item | D x L | R.C. | | D x L | R.C. | | D x L | R.C. | | D x L | R.C. | | | | |
| | | | | 120Hz | 100KHz | | 120Hz | 100KHz | | 120Hz | 100KHz | | 120Hz | 100KHz | | | |
| 10 | | 10x16 | 150 | 375 | 10x20 | 105 | 263 | 10x20 | 80 | 200 | 13x21 | 75 | 187.5 | | | | |
| 15 | | 10x20 | 170 | 425 | 13x21 | 130 | 325 | 13x21 | 110 | 275 | 13x21 | 90 | 225 | | | | |
| 22 | | 13x21 | 250 | 625 | 13x25 | 210 | 525 | 13x25 | 180 | 450 | 13x25 | 170 | 425 | | | | |
| 33 | | 13x25 | 350 | 875 | 16x22 | 270 | 675 | 16x25 | 330 | 825 | 16x25 | 260 | 650 | | | | |
| 47 | | 13x25 | 480 | 1200 | 18x26 | 450 | 1125 | 18x26 | 400 | 1000 | 18x32 | 350 | 875 | | | | |
| 56 | | 16x25 | 500 | 1250 | 18x26 | 550 | 1375 | 18x26 | 500 | 1250 | 18x35 | 520 | 1300 | | | | |
| 68 | | 18x26 | 650 | 1625 | 18x32 | 600 | 1500 | 18x32 | 600 | 1500 | 18x35 | 550 | 1375 | | | | |
| 82 | | 18x26 | 750 | 1875 | 18x32 | 650 | 1625 | 18x32 | 650 | 1625 | 18x40 | 650 | 1625 | | | | |
| 100 | | 18x32 | 800 | 1800 | 18x35 | 750 | 1688 | 18x35 | 750 | 1688 | 18x45 | 700 | 1575 | | | | |
| 120 | | 18x35 | 850 | 1913 | 18x40 | 800 | 1800 | 18x40 | 800 | 1800 | 22x45 | 800 | 1800 | | | | |
| 150 | | 18x40 | 900 | 2025 | 20x45 | 900 | 2025 | 20x45 | 900 | 2025 | | | | | | | |

※ 13mm may be replaced by 12.5mm upon customer's request.

Aluminum Electrolytic Capacitors

RHL Series

- On the basis of HH series Life promotion product
- Suitable for LED Lighting Power Supply Circuit
- RoHS Compliance.

Specifications

| Item | Characteristics | | | | | |
|---|---|---|------------|------|-----|-----|
| Capacitance Tolerance | ± 20% (120Hz, 20°C) | | | | | |
| Operating Temperature | -40~+150°C | | -25~+150°C | | | |
| Rated Voltage Range | 16~400VDC | | 450VDC | | | |
| Leakage Current | $I \leq 0.01CV + 100$ (μA) (After 1minutes application of DC rated voltage, at 20 °C) | | | | | |
| Dissipation Factor | Measurement Frequency: 120Hz. Temperature: 20°C | | | | | |
| | Rated Voltage | 160~400 | | 450 | | |
| | tan δ(Max) | 0.24 | | 0.24 | | |
| Low Temperature Stability Impedance Ratio (Max) | Measurement Frequency: 120Hz. | | | | | |
| | Rated Voltage (V) | 160 | 200 | 250 | 400 | 450 |
| | Z(-25°C)/Z(20°C) | 3 | 3 | 3 | 6 | 6 |
| | Z(-40°C)/Z(20°C) | 8 | 8 | 8 | 10 | - |
| Load Life | The following specifications shall be satisfied when the capacitors are restored at 20 °C after subjected to DC Voltage with the rated ripple current is applied for 2,000 hours ($\phi D \leq 10:15,000$ hours) at 105 °C | | | | | |
| | Capacitance Change | Within ± 30% of Initial Value | | | | |
| | tan δ | 300% or less of Initial Specified Value | | | | |
| | Leakage Current | Initial Specified Value or less | | | | |
| Shelf Life | The following specifications shall be satisfied when the capacitors are restored to 20°C after exposing them for 1,000 hours 105°C without voltage applied. Before the measurement, the capacitor shall be preconditioned by applying voltage according to them 4.1 of JIS C5101-4. | | | | | |
| | Capacitance Change | Within ± 30% of Initial Value | | | | |
| | tan δ | 300% or less of Initial Specified Value | | | | |
| | Leakage Current | Initial Specified Value or less | | | | |
| Standards | JIS C 5101-4-1 (IEC 60384) | | | | | |

Frequency Coefficient of Permissible Ripple Current

| Rated Voltage (V) | Capacitance (μF) | Frequency | | | |
|-------------------|------------------|-----------|------|------|------|
| | | 120 | 1K | 10K | 100K |
| 160~400 | 2.2~5.6 | 1.00 | 1.60 | 1.80 | 2.00 |
| | 6.8~18 | 1.00 | 1.50 | 1.70 | 1.90 |
| | 22~33 | 1.00 | 1.40 | 1.60 | 1.80 |
| 450 | 4.7~15 | 0.3 0 | 0.60 | 0.90 | 1.00 |
| | 22~120 | 0.4 | 0.70 | 0.90 | 1.00 |

The endurance of capacitors is reduced with internal heating produced by ripple current at the rate of halving the lifetime with every 5°C rise. When long life performance is required in actual use, the rms ripple current has to be reduced.

Aluminum Electrolytic Capacitors

RHL Series

Dimensions (mm)

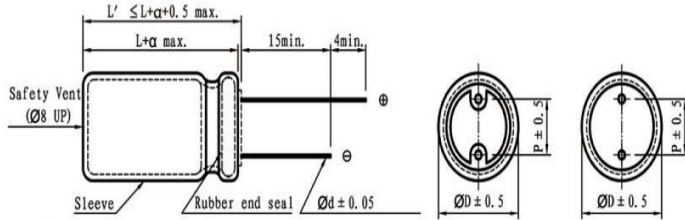

| | | | | | | |
|----|-----|-----|-----|-----|-----|-----|
| ØD | 10 | 13 | 16 | 18 | 20 | 22 |
| P | 5.0 | 5.0 | 7.5 | 7.5 | 10 | 10 |
| Ød | 0.6 | 0.6 | 0.8 | 0.8 | 0.8 | 0.8 |

D x L(mm), R.C. (mA rms) at 105°C

| Cap (µF) | V (Code) Item | 160 | | | 200 | | | 250 | | |
|----------|---------------|----------|-------|--------|---------|-------|--------|---------|-------|--------|
| | | D x L | R.C. | | D x L | R.C. | | D x L | R.C. | |
| | | | 120HZ | 100KHZ | | 120HZ | 100KHZ | | 120HZ | 100KHZ |
| 5.6 | | 6.3 x 11 | 52 | 104 | 8 x 10 | 56 | 112 | 8 x 12 | 62 | 124 |
| 6.8 | | | | | 8 x 10 | 62 | 117 | 8 x 12 | 68 | 129 |
| 8.2 | | | | | 8 x 10 | 88 | 125 | 10 x 10 | 76 | 144 |
| 10 | | 8 x 10 | 70 | 133 | 8 x 12 | 80 | 152 | 10 x 13 | 90 | 171 |
| 12 | | | | | 10 x 10 | 88 | 167 | 10 x 13 | 97 | 184 |
| 15 | | 8 x 12 | 92 | 174 | | | | | | |
| | | 10 x 10 | 95 | 180 | | | | | | |
| 18 | | | | | 10 x 13 | 113 | 214 | 10 x 16 | 127 | 241 |
| 22 | | 10 x 13 | 121 | 217 | 8 x 4 | 56 | 112 | | | |
| 27 | | | | | 10 x 16 | 149 | 268 | | | |
| 33 | | 10 x 16 | 158 | 284 | | | | | | |

| Cap(µF) | V (Code) Item | 400 | | | 450 | | |
|---------|---------------|---------|-------|--------|---------|-------|--------|
| | | D x L | R.C. | | D x L | R.C. | |
| | | | 120HZ | 100KHZ | | 120HZ | 100KHZ |
| 2.2 | | 8 x 12 | 40 | 80 | | | |
| 2.7 | | 8 x 12 | 43 | 86 | | | |
| 3.3 | | 8 x 12 | 47 | 94 | | | |
| | | 10 x 10 | 48 | 96 | | | |
| 3.9 | | 10 x 13 | 57 | 114 | | | |
| 4.7 | | 10 x 13 | 61 | 122 | 10 x 16 | 54 | 180 |
| | | | | | 10 x 20 | 66 | 220 |
| 6.8 | | 10 x 16 | 85 | 162 | 10 x 20 | 84 | 280 |
| 8.2 | | 10 x 16 | 88 | 167 | 10 x 20 | 84 | 280 |
| 10 | | 10 x 20 | 115 | 219 | 13 x 21 | 135 | 450 |
| 15 | | 13 x 21 | 150 | 285 | 13 x 25 | 180 | 600 |
| 22 | | 13 x 21 | 209 | 376 | 13 x 25 | 240 | 600 |
| | | | | | 16 x 20 | 292 | 730 |
| 33 | | 16 x 22 | 297 | 535 | 16 x 25 | 392 | 980 |
| | | | | | 18 x 20 | 312 | 780 |
| 47 | | | | | 18 x 25 | 480 | 1200 |
| 68 | | | | | 18 x 32 | 520 | 1300 |
| 82 | | | | | 18 x 35 | 574 | 1435 |
| 100 | | | | | 18 x 40 | 650 | 1625 |
| 120 | | | | | 20 x 45 | 720 | 1800 |

Aluminum Electrolytic Capacitors

RHM Series

- On the basis of SEA series ripple promotion product
- Suitable for LCD TV Power, SMPS
- RoHS Compliance.

Specifications

| Item | Characteristics | | | | |
|---|---|---|------|---------------|---------|
| Capacitance Tolerance | ± 20% (120Hz, 20°C) | | | | |
| Operating Temperature | -40~+150°C | | | -25~+150°C | |
| Rated Voltage Range | 160VDC~400VDC | | | 450VDC~460VDC | |
| Leakage Current | $I \leq 0.03CV + 20 (\mu A)$ (After 3minutes application of DC rated voltage, at 20 °C) | | | | |
| Dissipation Factor | Measurement Frequency: 120Hz. Temperature: 20°C | | | | |
| | Rated Voltage | 160~250 | 350 | 400 | 450~460 |
| | tan δ(Max) | 0.15 | 0.15 | 0.20 | 0.20 |
| Low Temperature Stability Impedance Ratio (Max) | When the nominal capacitance over 1000μF, tan shall be added 0.02 to the listed value with increase of every 1000μF | | | | |
| | Measurement Frequency: 120Hz. | | | | |
| | Rated Voltage (V) | 160~250 | 350 | 400~450 | 460 |
| | Z(-25°C)/Z(20°C) | 3 | 5 | 6 | 6 |
| | Z(-40°C)/Z(20°C) | 6 | - | - | - |
| Load Life | 5000hours, with application of rated voltage at 105°C | | | | |
| | Capacitance Change | Within ± 20% of Initial Value | | | |
| | tan δ | 200% or less of Initial Specified Value | | | |
| | Leakage Current | Initial Specified Value or less | | | |
| Shelf Life | The following specifications shall be satisfied when the capacitors are restored to 20°C after exposing them for 1,000 hours 105°C without voltage applied. Before the measurement, the capacitor shall be preconditioned by applying voltage according to them 4.1 of JIS C5101-4. | | | | |
| | Capacitance Change | Within ± 20% of Initial Value | | | |
| | tan δ | 200% or less of Initial Specified Value | | | |
| | Leakage Current | Initial Specified Value or less | | | |
| Standards | JIS C 5101-4-1 (IEC 60384) | | | | |

Frequency Coefficient of Permissible Ripple Current

| Capacitance (μF) | Frequency (Hz) | | | | |
|------------------|----------------|------|------|------|------|
| | 120 | 1K | 10K | 50K | 100K |
| 10~82 | 1.00 | 1.75 | 2.25 | 2.23 | 2.50 |
| 100~150 | 1.00 | 1.67 | 2.05 | 2.15 | 2.25 |

The endurance of capacitors is reduced with internal heating produced by ripple current at the rate of halving the lifetime with every 5°C rise. When long life performance is required in actual use, the rms ripple current has to be reduced.

Aluminum Electrolytic Capacitors

RHM Series

Dimensions (mm)

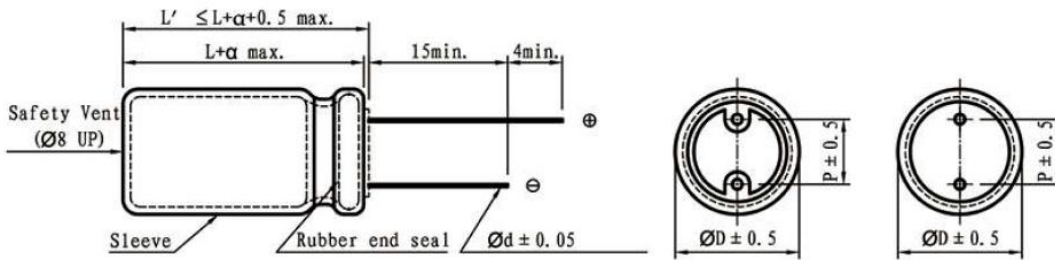

| | |
|----------|-------------------|
| α | (L < 16) 1.0 |
| | (L \geq 16) 2.0 |

| | | | | | | |
|-----------------|-----|-----|-----|-----|-----|-----|
| $\varnothing D$ | 10 | 13 | 16 | 18 | 20 | 22 |
| P | 5.0 | 5.0 | 7.5 | 7.5 | 10 | 10 |
| $\varnothing d$ | 0.6 | 0.6 | 0.8 | 0.8 | 0.8 | 0.8 |

Standard Ratings

| Cap (μF) | V | 160 | | 200 | | 250 | | 350 | |
|--------------------|------|---------|------|---------|------|---------|------|---------|------|
| | Item | D x L | R.C. | D x L | R.C. | D x L | R.C. | D x L | R.C. |
| 10 | | 8 x 12 | 140 | 8 x 14 | 180 | 10 x 13 | 180 | 8 x 20 | 180 |
| 22 | | 8 x 16 | 220 | 8 x 16 | 220 | 10 x 16 | 200 | 8 x 30 | 250 |
| 27 | | 10 x 14 | 220 | 10 x 13 | 220 | 10 x 20 | 240 | 10 x 25 | 280 |
| 33 | | 8 x 20 | 280 | 10 x 16 | 250 | 10 x 20 | 260 | 13 x 21 | 350 |
| 47 | | 10 x 20 | 320 | 10 x 20 | 280 | 10 x 25 | 320 | 13 x 25 | 380 |
| 56 | | 10 x 25 | 360 | 10 x 25 | 320 | 10 x 25 | 320 | 13 x 25 | 380 |
| 68 | | 10 x 25 | 360 | 10 x 25 | 330 | 13 x 21 | 445 | 16 x 22 | 450 |
| 82 | | 13 x 21 | 445 | 10 x 30 | 390 | 13 x 25 | 520 | 16 x 25 | 550 |
| 100 | | 10 x 30 | 445 | 10 x 35 | 485 | 13 x 30 | 580 | 16 x 25 | 650 |
| 100 | | 13 x 25 | 520 | 10 x 40 | 560 | 16 x 25 | 650 | 16 x 25 | 700 |

| Cap (μF) | V | 400 | | 450 | | 460 | |
|--------------------|------|---------|------|---------|------|---------|------|
| | Item | D x L | R.C. | D x L | R.C. | D x L | R.C. |
| 10 | | 10 X 16 | 160 | 10 X 20 | 180 | 10 x 20 | 150 |
| 15 | | 10 X 20 | 180 | 13 X 21 | 300 | 13 x 21 | 210 |
| 22 | | 13 X 21 | 300 | 13 X 25 | 390 | 13 x 25 | 280 |
| 33 | | 13 X 25 | 390 | 16 X 22 | 450 | 16 x 25 | 430 |
| 47 | | 13 X 25 | 430 | 18 X 25 | 650 | 18 x 25 | 500 |
| 56 | | 16 X 25 | 530 | 18 X 25 | 700 | 18 x 25 | 540 |
| 68 | | 18 X 25 | 680 | 18 X 32 | 750 | 18 x 32 | 680 |
| 82 | | 18 X 25 | 760 | 18 X 32 | 780 | 18 x 32 | 720 |
| 100 | | 18 X 32 | 830 | 18 X 35 | 820 | 18 x 35 | 800 |
| 120 | | 18 X 35 | 880 | 18 X 40 | 920 | 18 x 45 | 1000 |
| 150 | | 18 X 40 | 950 | 20 X 45 | 1080 | 20 x 45 | 1050 |

13mm may be replaced by 12.5mm upon customer's request.

Aluminum Electrolytic Capacitors RMI Series

- 105°C 10000 hours, miniaturized and long life.
- RoHS Compliant & Halogen Free

Specifications

| Items | Characteristics | | | | | | | | |
|--|---|---|------|------|-----|------|------|------|------|
| Capacitance Tolerance | ± 20% (120Hz, 20°C) | | | | | | | | |
| Operating Temperature Range | -25 ~ +105°C | | | | | | | | |
| Rated Voltage Range | 10 ~ 100VDC | | | | | | | | |
| Leakage Current | I ≤ 0.01CV or 3 (μA) which is greater. (After 2 minutes application of DC rated voltage, at 20 °C) | | | | | | | | |
| Dissipation Factor | Measurement Frequency: 120Hz. Temperature: 20°C | | | | | | | | |
| | Rated Voltage (V) | 6.3 | 10 | 16 | 25 | 35 | 50 | 63 | 100 |
| | tan δ(Max) | 0.45 | 0.45 | 0.35 | 0.3 | 0.22 | 0.19 | 0.17 | 0.15 |
| Low Temperature Stability Impedance Ratio (Max) | Measurement Frequency: 120Hz. | | | | | | | | |
| | Rated Voltage(V) | 10 | 16 | 25 | 35 | 50 | 63 | 100 | |
| | Z(-25°C)/Z(20°C) | 8 | 6 | 4 | 4 | 3 | 3 | 3 | |
| Load Life | 10,000 hours, with application of rated voltage at 105°C. | | | | | | | | |
| | Capacitance Change | Within ± 25% of Initial Value | | | | | | | |
| | tan δ | 300% or less of Initial Specified Value | | | | | | | |
| | Leakage Current | Initial Specified Value or less | | | | | | | |
| Shelf Life | The following specifications shall be satisfied when the capacitors are restored to 20°C after exposing them for 1,000 hours 105°C without voltage applied. Before the measurement, the capacitor shall be preconditioned by applying voltage according to them 4.1 of JIS C5101-4. | | | | | | | | |
| | Capacitance Change | Within ± 25% of Initial Value | | | | | | | |
| | tan δ | 300% or less of Initial Specified Value | | | | | | | |
| | Leakage Current | Initial Specified Value or less | | | | | | | |
| Standards | JIS C 5101-4-1 (IEC 60384) | | | | | | | | |

Frequency Coefficient of Permissible Ripple Current

| Rated Voltage (V) | Capacitance (μF) | Frequency (Hz) | | | |
|-------------------|------------------|----------------|------|------|------|
| | | 120 | 1K | 10K | 100K |
| 10 ~ 100 | 0.47~10 | 0.42 | 0.60 | 0.80 | 1.00 |
| | 22~33 | 0.55 | 0.75 | 0.90 | 1.00 |
| | 47~330 | 0.70 | 0.85 | 0.95 | 1.00 |

The endurance of capacitors is reduced with internal heating produced by ripple current at the rate of halving the lifetime with every 5°C rise. When long life performance is required in actual use, the rms ripple current has to be reduced.

Aluminum Electrolytic Capacitors

RMI Series

Dimensions (mm)

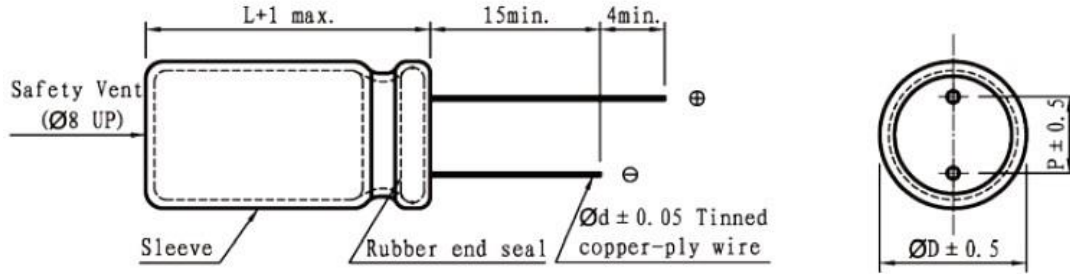

| | | | |
|----|-----|-----|-----|
| ØD | 5 | 6.3 | 8 |
| P | 2.0 | 2.5 | 3.5 |
| Ød | 0.5 | 0.5 | 0.5 |

Standard Ratings

DxL(mm) ; R.C.(mA rms) at 105°C 100KHz.

| Cap (µF) | V | 10 | | 16 | | 25 | | 35 | | 50 | | 63 | | 100 | |
|----------|---|--------|-------|--------|-------|--------|-------|--------|-------|--------|-------|--------|-------|--------|-------|
| | | Item | D x L | R.C. | D x L | R.C. | D x L | R.C. | D x L | R.C. | D x L | R.C. | D x L | R.C. | D x L |
| 0.47 | | | | | | | | | | 5x12 | 12 | | | 5x12 | 20 |
| 1 | | | | | | | | | | 5x12 | 25 | | | 5x12 | 40 |
| 2.2 | | | | | | | | | | 5x12 | 35 | | | 5x12 | 50 |
| 3.3 | | | | | | | | | | 5x12 | 70 | | | 5x12 | 60 |
| 4.7 | | | | | | | | | | 5x12 | 80 | | | 5x12 | 70 |
| 10 | | | | | | | | | | 5x12 | 90 | 5x12 | 80 | 6.3x12 | 150 |
| 22 | | | | | | | | | | 5x12 | 120 | 6.3x12 | 170 | 8x12 | 230 |
| 33 | | | | | | 5x12 | 124 | 5x12 | 130 | 6.3x12 | 190 | 6.3x12 | 170 | | |
| 47 | | | | 5x12 | 130 | 5x12 | 157 | 6.3x12 | 210 | 6.3x12 | 190 | 8x12 | 240 | | |
| 100 | | 5x12 | 130 | 6.3x12 | 210 | 6.3x12 | 210 | 8x12 | 330 | 8x12 | 270 | | | | |
| 220 | | 6.3x12 | 210 | 8x12 | 330 | | | | | | | | | | |
| 330 | | 8x12 | 330 | | | | | | | | | | | | |

Aluminum Electrolytic Capacitors

RHE Series

- 105°C high-temperature resistance, standard product
- 3000 hours Load Life
- Suitable for LED and electronic rectifier
- RoHS Compliant & Halogen Free

Specifications

| Items | Characteristics | | | | | | |
|-----------------------------|---|---|------|---|------|------|------|
| Capacitance Tolerance | ± 20% (120Hz, 20°C) | | | | | | |
| Operating Temperature Range | -40 ~ +105°C | | | -25 ~ +105°C | | | |
| Rated Voltage Range | 160 ~ 400VDC | | | 450VDC | | | |
| Leakage Current | I ≤ 0.02CV +10 (μA) which is greater. (After 2 minutes application of DC rated voltage, at 20 °C) | | | I ≤ 0.03CV +10 (μA) (After 2 minutes application of DC rated voltage, at 20 °C) | | | |
| Dissipation Factor | Measurement Frequency: 120Hz. Temperature: 20°C | | | | | | |
| | Rated Voltage (V) | 160~180 | 200 | 250 | 350 | 400 | 450 |
| | tan δ(Max) | 0.15 | 0.15 | 0.15 | 0.15 | 0.20 | 0.20 |
| Low Temperature Stability | Measurement Frequency: 120Hz. | | | | | | |
| | Rated Voltage(V) | 160 | 200 | 250 | 350 | 400 | 450 |
| | Impedance Ratio (Max) | Z(-25°C)/Z(20°C) | 3 | 3 | 3 | 5 | 5 |
| | Z(-40°C)/Z(20°C) | 6 | 6 | 6 | 6 | 6 | - |
| Load Life | 3000hours, with application of rated voltage at 105°C | | | | | | |
| | Capacitance Change | Within ± 20% of Initial Value | | | | | |
| | tan δ | 200% or less of Initial Specified Value | | | | | |
| | Leakage Current | Initial Specified Value or less | | | | | |
| Shelf Life | The following specifications shall be satisfied when the capacitors are restored to 20°C after exposing them for 1,000 hours 105°C without voltage applied. Before the measurement, the capacitor shall be preconditioned by applying voltage according to them 4.1 of JIS C5101-4. | | | | | | |
| | Capacitance Change | Within ± 20% of Initial Value | | | | | |
| | tan δ | 200% or less of Initial Specified Value | | | | | |
| | Leakage Current | 500% or less of Initial Specified Value | | | | | |
| Standards | JIS C-5101-4(IEC 60384) | | | | | | |

Frequency Coefficient of Permissible Ripple Current

| Rated Voltage (V) | Frequency (Hz) | | | |
|-------------------|----------------|------|---------|----------|
| | 120 | 1K | 10K~20K | 30K~100K |
| 160~250 | 0.55 | 0.85 | 0.90 | 1.00 |
| 350~450 | 0.50 | 0.80 | 0.90 | 1.00 |

The endurance of capacitors is reduced with internal heating produced by ripple current at the rate of halving the lifetime with every 5°C rise. When long life performance is required in actual use, the rms ripple current has to be reduced.

Aluminum Electrolytic Capacitors RHE Series

Dimensions (mm)

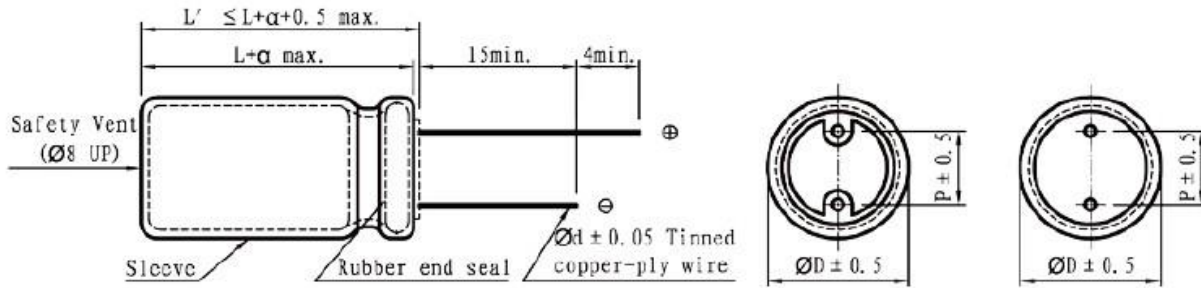

| | | | | | | | | |
|-----------------|-----|-----|-----|-----|-----|-----|----------------------------|-------------------|
| $\varnothing D$ | 6.3 | 8 | 10 | 13 | 16 | 18 | α | (L < 16) 1.0 |
| P | 2.5 | 3.5 | 5.0 | 5.0 | 7.5 | 7.5 | | (L \geq 16) 2.0 |
| $\varnothing d$ | 0.5 | 0.5 | 0.6 | 0.6 | 0.8 | 0.8 | | |

Standard Ratings

D x L (mm) ; R.C. (mA rms) at 105°C 100KHz.

| Cap (μF) | V 160 | | 200 | | 250 | | |
|--------------------|-------|--------|------|--------|------|-------|------|
| | Item | D x L | R.C. | D x L | R.C. | D x L | R.C. |
| 2.2 | | 6.3x11 | 36 | 6.3x11 | 38 | 8x12 | 47 |
| 3.3 | | 8x12 | 50 | 8x12 | 59 | 8x12 | 69 |
| 4.7 | | 8x12 | 55 | 8x12 | 65 | 8x12 | 70 |
| 5.6 | | 8x12 | 65 | 8x12 | 75 | 8x16 | 85 |
| 6.8 | | 8x12 | 70 | 8x14 | 80 | 10x13 | 95 |
| 8.2 | | 8x12 | 80 | 8x16 | 85 | 10x16 | 105 |
| 10 | | 8x12 | 85 | 10x13 | 120 | 10x16 | 150 |
| 15 | | 8x16 | 120 | 10x13 | 150 | 10x16 | 180 |
| 22 | | 10x16 | 195 | 10x16 | 210 | 10x20 | 250 |
| 33 | | 10x20 | 230 | 13x21 | 280 | 13x21 | 320 |
| 47 | | 13x21 | 310 | 13x21 | 395 | 13x25 | 410 |
| 68 | | 13x21 | 380 | 13x25 | 460 | 16x26 | 480 |
| 82 | | 13x25 | 430 | 13x25 | 570 | 16x26 | 590 |
| 100 | | 16x26 | 640 | 16x26 | 670 | 16x32 | 720 |
| 150 | | 16x26 | 700 | 16x32 | 790 | 18x32 | 875 |
| 220 | | 16x36 | 990 | 18x35 | 1040 | 18x40 | 1100 |

RHE Series

Standard Ratings

DxL(mm) ; R.C.(mA rms) at 105°C 100KHz.

| Ca p (μ F) | V | 350 | | 400 | | 450 | |
|-----------------------|------|-------|------|-------|------|-------|------|
| | Item | D x L | R.C. | D x L | R.C. | D x L | R.C. |
| 1 | | 8x12 | 33 | 8x12 | 35 | 8x16 | 30 |
| 1.5 | | 8x12 | 42 | 8x12 | 45 | 10x16 | 50 |
| 2.2 | | 8x12 | 47 | 8x12 | 55 | 10x16 | 60 |
| 3.3 | | 8x16 | 60 | 10x13 | 75 | 10x16 | 90 |
| 4.7 | | 10x13 | 95 | 10x16 | 100 | 10x20 | 115 |
| 6.8 | | 10x13 | 100 | 10x16 | 125 | 13x21 | 130 |
| 8.2 | | 10x16 | 130 | 10x20 | 145 | 13x21 | 155 |
| 10 | | 10x20 | 145 | 10x20 | 150 | 13x21 | 160 |
| 15 | | 13x21 | 205 | 13x21 | 210 | 13x21 | 255 |
| 22 | | 13x25 | 270 | 13x25 | 285 | 16x26 | 280 |
| 33 | | 16x26 | 355 | 16x26 | 400 | 16x32 | 455 |
| 47 | | 16x26 | 430 | 16x26 | 480 | 18x32 | 550 |
| 68 | | 16x32 | 505 | 16x32 | 585 | 18x35 | 690 |
| 82 | | 16x36 | 655 | 18x32 | 695 | 18x35 | 805 |
| 100 | | 18x32 | 750 | 18x35 | 795 | 18x40 | 860 |

※ 13mm may be replaced by 12.5mm upon customer's request.

RHF Series

- 105°C high-temperature resistance, high ripple current and long life
- 5000hours load life
- Suitable for LED and electronic rectifier
- RoHS Compliant & Halogen Free

Specifications

| Items | Characteristics | | | | | | |
|-----------------------------|--|---|------|--|------|------|---------|
| Capacitance Tolerance | ± 20% (120Hz, 20°C) | | | | | | |
| Operating Temperature Range | -40 ~ +105°C | | | -25 ~ +105°C | | | |
| Rated Voltage Range | 160 ~ 400VDC | | | 450VDC | | | |
| Leakage Current | I ≤ 0.02CV + 10 μA, which is greater. (After 2 minutes application of DC rated voltage at 20 °C) | | | I ≤ 0.03CV + 10 (μA) (After 2 minutes application of DC rated voltage at 20 °C) | | | |
| Dissipation Factor | Measurement Frequency: 120Hz. Temperature: 20°C | | | | | | |
| | Rated Voltage (V) | 160 | 200 | 250 | 350 | 400 | 450~500 |
| | tan δ(Max) | 0.15 | 0.15 | 0.15 | 0.15 | 0.20 | 0.20 |
| Low Temperature Stability | Measurement Frequency: 120Hz. Temperature: 20°C | | | | | | |
| | Rated Voltage(V) | 160 | 200 | 250 | 350 | 400 | 450 |
| | Z(-25°C) / Z(20°C) | 3 | 3 | 3 | 5 | 5 | 6 |
| Impedance Ratio (Max) | Z(-40°C) / Z(20°C) | 6 | 6 | 6 | 6 | 6 | - |
| | 5,000 hours, with application of working voltage at 105°C | | | | | | |
| | Capacitance Change | Within ± 20% of Initial Value | | | | | |
| Load Life | tan δ | 200% or less of Initial Specified Value | | | | | |
| | Leakage Current | Initial Specified Value or less | | | | | |
| | The following specifications shall be satisfied when the capacitors are restored to 20°C after exposing them for 1,000 hours 105°C without voltage applied. Before the measurement the capacitor shall be preconditioned by applying voltage according to them 4.1 of JIS C5101-4. | | | | | | |
| Shelf Life | Capacitance Change | Within ± 20% of Initial Value | | | | | |
| | tan δ | 200% or less of Initial Specified Value | | | | | |
| | Leakage Current | 500% or less of Initial Specified Value | | | | | |
| Standards | JIS C-5101-4(IEC 60384) | | | | | | |

Frequency Coefficient of Permissible Ripple Current

| Rated Voltage (V) | Frequency (Hz) | | | |
|-------------------|----------------|------|---------|----------|
| | 120 | 1K | 10K~20K | 30K~100K |
| 160~250 | 0.55 | 0.85 | 0.90 | 1.00 |
| 350~450 | 0.50 | 0.80 | 0.90 | 1.00 |

The endurance of capacitors is reduced with internal heating produced by ripple current at the rate of halving the lifetime with every 5°C rise. When long life performance is required in actual use, the RMS ripple current has to be reduced.

RHF Series

Dimensions (mm)

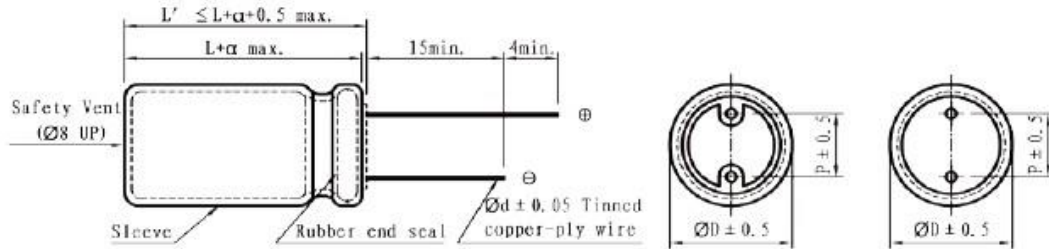

| | | | | | | |
|----|-----|-----|-----|-----|-----|-----|
| ØD | 6.3 | 8 | 10 | 13 | 16 | 18 |
| P | 2.5 | 3.5 | 5.0 | 5.0 | 7.5 | 7.5 |
| Ød | 0.5 | 0.5 | 0.6 | 0.6 | 0.8 | 0.8 |

| | |
|----------|--------------|
| α | (L < 16) 1.0 |
| | (L ≥ 16) 2.0 |

Standard Ratings

DxL(mm) ; R.C.(mA rms) at 105°C 100KHz.

| Ca p (µF) | V | 160 | | 200 | | 250 | |
|-----------------|------|--------|------|-------|------|-------|------|
| | Item | D x L | R.C. | D x L | R.C. | D x L | R.C. |
| 2.2 | | 6.3x11 | 60 | 8x12 | 68 | 8x12 | 70 |
| 3.3 | | 8x12 | 72 | 8x12 | 75 | 8x12 | 80 |
| 4.7 | | 8x12 | 75 | 8x12 | 80 | 10x13 | 85 |
| 5.6 | | 8x12 | 80 | 8x16 | 85 | 10x13 | 90 |
| 6.8 | | 8x12 | 90 | 8x16 | 95 | 10x13 | 100 |
| 8.2 | | 8x12 | 95 | 8x16 | 110 | 10x16 | 130 |
| 10 | | 8x12 | 100 | 10x16 | 180 | 10x20 | 200 |
| 15 | | 10x16 | 210 | 10x16 | 230 | 10x20 | 260 |
| 22 | | 10x20 | 300 | 10x20 | 330 | 10x20 | 380 |
| 33 | | 10x20 | 330 | 13x21 | 400 | 13x25 | 450 |
| 47 | | 13x21 | 400 | 13x21 | 450 | 13x25 | 520 |
| 68 | | 13x25 | 490 | 16x26 | 560 | 16x32 | 630 |
| 82 | | 13x25 | 550 | 16x26 | 640 | 16x32 | 700 |
| 100 | | 16x26 | 680 | 16x26 | 720 | 18x32 | 830 |
| 150 | | 16x32 | 930 | 16x36 | 1030 | 18x35 | 1230 |
| 220 | | 18x32 | 1050 | 18x35 | 1250 | 18x40 | 1340 |

RHF Series

Standard Ratings

DxL(mm) ; R.C.(mA RMS) at 105°C 100KHz..

| Cap (μF) | V | 350 | | 400 | | 450 | | |
|-------------|---|------|-------|------|-------|------|-------|------|
| | | Item | D x L | R.C. | D x L | R.C. | D x L | R.C. |
| 1 | | | 8x12 | 43 | 8x16 | 50 | 8x16 | 60 |
| 1.5 | | | 8x12 | 45 | 10x13 | 53 | 10x16 | 63 |
| 2.2 | | | 8x12 | 53 | 10x13 | 63 | 10x16 | 70 |
| 3.3 | | | 10x13 | 80 | 10x16 | 90 | 10x16 | 95 |
| 4.7 | | | 10x16 | 90 | 10x16 | 100 | 10x20 | 105 |
| 5.6 | | | 10x16 | 100 | 10x16 | 108 | 10x20 | 110 |
| 6.8 | | | 10x20 | 130 | 10x20 | 155 | 13x21 | 160 |
| 8.2 | | | 13x21 | 160 | 13x21 | 190 | 13x21 | 220 |
| 10 | | | 13x21 | 190 | 13x21 | 230 | 13x21 | 250 |
| 15 | | | 13x25 | 230 | 13x25 | 250 | 13x25 | 300 |
| 22 | | | 16x26 | 300 | 16x26 | 380 | 16x32 | 430 |
| 33 | | | 16x26 | 350 | 16x32 | 430 | 16x36 | 560 |
| 47 | | | 16x36 | 480 | 18x26 | 580 | 18x32 | 630 |
| 68 | | | 18x26 | 560 | 18x32 | 650 | 18x35 | 780 |
| 82 | | | 18x32 | 730 | 18x35 | 800 | 18x40 | 950 |
| 100 | | | 18x35 | 840 | 18x40 | 930 | | |

※ 13mm may be replaced by 12.5mm upon customer's request.

RHH Series

- 105°C high-temperature resistance, high ripple current and long life
- 10000hours load life
- Suitable for LED and electronic rectifier
- RoHS Compliant & Halogen Free

Specifications

| Items | Characteristics | | | | | | | |
|-----------------------------|---|---|------|--|------|------|------|---------|
| Capacitance Tolerance | ± 20% (120Hz, 20°C) | | | | | | | |
| Operating Temperature Range | -40 ~ +105°C | | | -25 ~ +105°C | | | | |
| Rated Voltage Range | 160 ~ 400VDC | | | 450VDC | | | | |
| Leakage Current | I ≤ 0.02CV +10 (μA) which is greater. (After 2 minutes application of DC rated voltage, at 20 °C) | | | I ≤ 0.03CV +10 (μA) (After 2 minutes application of DC rated voltage, at 20 °C) | | | | |
| Dissipation Factor | Measurement Frequency: 120Hz. Temperature: 20°C | | | | | | | |
| | Rated Voltage (V) | 160 | 200 | 250 | 350 | 400 | 450 | 420~500 |
| | tan δ(Max) | 0.15 | 0.15 | 0.15 | 0.15 | 0.20 | 0.20 | 0.20 |
| Low Temperature Stability | Measurement Frequency: 120Hz. | | | | | | | |
| | Rated Voltage(V) | 160 | 200 | 250 | 350 | 400 | 450 | |
| | Impedance Ratio (Max) | Z(-25°C)/Z(20°C) | 3 | 3 | 3 | 5 | 5 | 6 |
| | | Z(-40°C)/Z(20°C) | 6 | 6 | 6 | 6 | 6 | - |
| Load Life | 10000 hours, with application of rated voltage at 105°C (8ψ ~ 10ψ: 8000 hours) | | | | | | | |
| | Capacitance Change | Within ± 20% of Initial Value | | | | | | |
| | tan δ | 200% or less of Initial Specified Value | | | | | | |
| Shelf Life | Leakage Current | Initial Specified Value or less | | | | | | |
| | The following specifications shall be satisfied when the capacitors are restored to 20°C after exposing them for 1,000 hours 105°C without voltage applied. Before the measurement, the capacitor shall be preconditioned by applying voltage according to them 4.1 of JIS C5101-4. | | | | | | | |
| | Capacitance Change | Within ± 20% of Initial Value | | | | | | |
| | tan δ | 200% or less of Initial Specified Value | | | | | | |
| | Leakage Current | 500% or less of Initial Specified Value | | | | | | |
| Standards | JIS C-5101-4(IEC 60384) | | | | | | | |

Frequency Coefficient of Permissible Ripple Current

| Frequency (Hz) | 50 | 120 | 1K | 10K | 100K |
|----------------|------|------|------|------|------|
| Coefficient | 0.45 | 0.55 | 0.75 | 0.90 | 1.00 |

The endurance of capacitors is reduced with internal heating produced by ripple current at the rate of halving the lifetime with every 5°C rise. When long life performance is required in actual use, the rms ripple current has to be reduced.

RHH Series

Dimensions (mm)

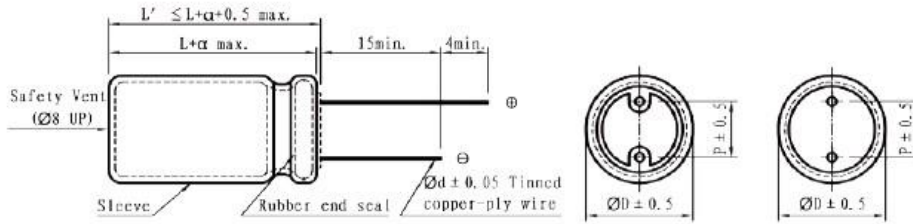

| | | | | | | | | |
|----|-----|-----|-----|-----|-----|-----|----------|--------------|
| ØD | 8 | 10 | 13 | 16 | 18 | 22 | α | (L < 16) 1.0 |
| P | 3.5 | 5.0 | 5.0 | 7.5 | 7.5 | 10 | | (L ≥ 16) 2.0 |
| Ød | 0.5 | 0.6 | 0.6 | 0.8 | 0.8 | 0.8 | | |

Standard Ratings

DxL(mm) ; R.C.(mA rms) at 105°C 100KHz.

| Cap (µF) | V | 160 | | 200 | | 250 | |
|----------|------|-------|------|-------|------|-------|------|
| | Item | D x L | R.C. | D x L | R.C. | D x L | R.C. |
| 2.2 | | 8x12 | 80 | 8x12 | 90 | 8x12 | 90 |
| 3.3 | | 8x12 | 90 | 8x12 | 102 | 10x13 | 110 |
| 4.7 | | 8x12 | 98 | 8x16 | 110 | 10x16 | 120 |
| 5.6 | | 8x16 | 104 | 8x16 | 118 | 10x16 | 125 |
| 6.8 | | 8x16 | 115 | 10x13 | 128 | 10x16 | 130 |
| 8.2 | | 10x16 | 125 | 10x16 | 220 | 10x16 | 240 |
| 10 | | 10x16 | 255 | 10x16 | 260 | 10x20 | 290 |
| 15 | | 10x16 | 430 | 10x20 | 430 | 13x21 | 460 |
| 22 | | 10x20 | 510 | 13x21 | 510 | 13x21 | 610 |
| 33 | | 13x21 | 580 | 13x21 | 610 | 13x25 | 650 |
| 47 | | 13x25 | 670 | 13x25 | 670 | 16x26 | 730 |
| 68 | | 16x26 | 770 | 16x26 | 770 | 16x32 | 930 |
| 100 | | 16x26 | 900 | 16x26 | 1030 | 18x32 | 1210 |
| 150 | | 18x32 | 1270 | 18x35 | 1330 | 22x35 | 1530 |
| 220 | | 18x35 | 1410 | 22x35 | 1710 | | |

RHH Series

Standard Ratings

D×L(mm) ; R.C.(mA rms) at 105°C 100KHz.

| Cap (μF) | V | 350 | | 400 | | 450 | |
|-------------|------|-------|------|-------|------|-------|------|
| | Item | D x L | R.C. | D x L | R.C. | D x L | R.C. |
| 1 | | 8x12 | 74 | 8x16 | 85 | 10x13 | 90 |
| 1.5 | | 10x13 | 80 | 10x13 | 95 | 10x16 | 100 |
| 2.2 | | 10x16 | 98 | 10x16 | 105 | 10x16 | 110 |
| 3.3 | | 10x16 | 110 | 10x16 | 115 | 10x16 | 120 |
| 4.7 | | 10x20 | 145 | 10x20 | 148 | 10x20 | 150 |
| 5.6 | | 13x21 | 165 | 13x21 | 180 | 13x21 | 200 |
| 6.8 | | 13x21 | 200 | 13x21 | 230 | 13x21 | 260 |
| 8.2 | | 13x21 | 250 | 13x21 | 270 | 13x21 | 290 |
| 10 | | 13x21 | 290 | 13x21 | 300 | 13x21 | 330 |
| 15 | | 13x25 | 350 | 13x25 | 390 | 13x25 | 430 |
| 22 | | 16x26 | 450 | 16x26 | 500 | 16x32 | 600 |
| 33 | | 16x32 | 510 | 16x32 | 650 | 16x36 | 710 |
| 47 | | 16x36 | 670 | 18x26 | 850 | 18x32 | 900 |
| 68 | | 18x32 | 860 | 18x32 | 960 | 18x35 | 1150 |
| 82 | | 18x32 | 1150 | 18x35 | 1300 | 18x40 | 1400 |
| 100 | | 18x35 | 1250 | 18x40 | 1400 | | |

※ 13mm may be replaced by 12.5mm upon customer's request.

RLA Series

- High frequency and low impedance, high ripple current resistance.
- Suitable for return-circuit of switching power source.
- RoHS Compliant & Halogen Free

Specifications

| Items | Characteristics | | | | | | | | | | | | |
|-----------------------------|--|---|------|------|------|------|--------------|------|-------|---------|---------|---------|------|
| Capacitance Tolerance | ± 20% (120Hz, 20°C) | | | | | | | | | | | | |
| Operating Temperature Range | -40 ~ | | | | | | -25 ~ +105°C | | | | | | |
| Rated Voltage Range | 6.3 ~ 400VDC | | | | | | 450VDC | | | | | | |
| Leakage Current | $V \leq 100V$ $I \leq 0.01CV$ or 3 (μA) (After 2 minutes application of DC rated voltage, at 20°C) $V > 100V$ $I \leq 0.03CV + 20$ (μA) (After 5 minutes application of DC rated voltage, at 20°C) | | | | | | | | | | | | |
| Dissipation Factor | Measurement Frequency: 120Hz. Temperature: 20°C | | | | | | | | | | | | |
| | Rated Voltage (V) | 6.3 | 10 | 16 | 25 | 30 | 35 | 50 | 63~80 | 100 | 160~250 | 400~450 | 600 |
| | tan δ(Max) | 0.22 | 0.19 | 0.16 | 0.14 | 0.13 | 0.12 | 0.10 | 0.08 | 0.07 | 0.20 | 0.24 | 0.24 |
| | When nominal capacitance over 1000μF, tan δ shall be added 0.02 to the listed value with increase of every 1000μF. | | | | | | | | | | | | |
| Low Temperature Stability | Measurement Frequency: 120Hz. | | | | | | | | | | | | |
| | Rated Voltage(V) | 6.3 | 10 | 16 | 25 | 35 | 50 | 63 | 100 | 160~250 | 400 | 450 | |
| | Z(-25°C)/Z(20°C) | 4 | 3 | 2 | 2 | 2 | 2 | 2 | 2 | 3 | 5 | 6 | |
| | Z(-40°C)/Z(20°C) | 8 | 6 | 4 | 3 | 3 | 3 | 3 | 3 | 6 | 10 | 12 | |
| Load Life | 2,000 hours, with application of rated voltage at 105°C | | | | | | | | | | | | |
| | Capacitance Change | Within ± 20% of Initial Value | | | | | | | | | | | |
| | tan δ | 200% or less of Initial Specified Value | | | | | | | | | | | |
| | Leakage Current | Initial Specified Value or less | | | | | | | | | | | |
| Shelf Life | The following specifications shall be satisfied when the capacitors are restored to 20°C after exposing them for 1,000 hours 105°C without voltage applied. Before the measurement the capacitor shall be preconditioned by applying voltage according to them 4.1 of JIS C5101-4. | | | | | | | | | | | | |
| | Capacitance Change | Within ± 20% of Initial Value | | | | | | | | | | | |
| | tan δ | 200% or less of Initial Specified Value | | | | | | | | | | | |
| | Leakage Current | Initial Specified Value or less | | | | | | | | | | | |
| Standards | JIS C 5101-4 (IEC 60384) | | | | | | | | | | | | |

Frequency Coefficient of Permissible Ripple Current

| Rated Voltage (V) | Capacitance (μF) | Frequency (Hz) | | | | |
|-------------------|------------------|----------------|------|------|------|------|
| | | 50 | 120 | 1K | 10K | 100K |
| 6.3 ~ 100 | 0.47 ~ 100 | 0.45 | 0.55 | 0.75 | 0.90 | 1.00 |
| | 220 ~ 1000 | 0.60 | 0.70 | 0.85 | 0.95 | 1.00 |
| | 1500 ~ 15000 | 0.70 | 0.80 | 0.95 | 0.98 | 1.00 |
| 160 ~ 450 | 2.2 ~ 330 | 0.55 | 0.65 | 0.80 | 0.90 | 1.00 |

The endurance of capacitors is reduced with internal heating produced by ripple current at the rate of halving the lifetime with every 5°C rise. When long life performance is required in actual use, the RMS ripple current has to be reduced.

RLA Series

Dimensions (mm)

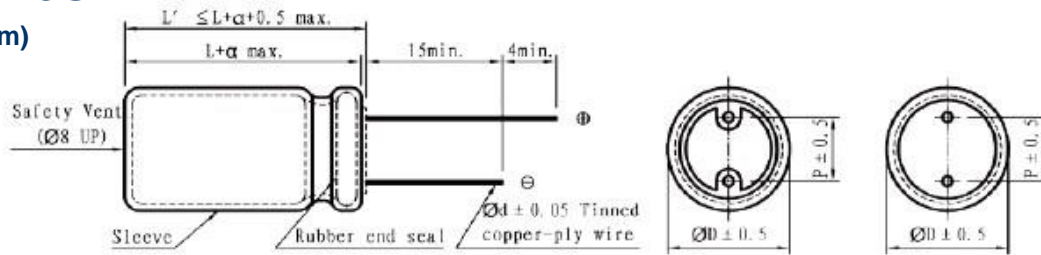

| | | | | | | | |
|-----------------|-----|-----|-----|-----|-----|-----|-----|
| $\varnothing D$ | 5 | 6.3 | 8 | 10 | 13 | 16 | 18 |
| P | 2.0 | 2.5 | 3.5 | 5.0 | 5.0 | 7.5 | 7.5 |
| $\varnothing d$ | 0.5 | 0.5 | 0.5 | 0.6 | 0.6 | 0.8 | 0.8 |

| | |
|----------|-------------------|
| α | (L < 16) 1.0 |
| | (L \geq 16) 2.0 |

Standard Ratings

DxL(mm) ; R.C.(mA rms) at 105°C 100KHz ; IMP (Ω max) at 20°C 100KHz.

| Cap (μF) | V | 6.3 | | | 10 | | | 16 | | | 25 | | |
|-----------------|------|--------|------|-------|--------|------|-------|--------|------|-------|--------|------|-------|
| | Item | D x L | R.C. | IMP | D x L | R.C. | IMP | D x L | R.C. | IMP | D x L | R.C. | IMP |
| 4.7 | | | | | | | | | | | 5x11 | 50 | 1.50 |
| 10 | | | | | | | | | | | 5x11 | 80 | 1.50 |
| 22 | | | | | | | | | | | 5x11 | 110 | 0.800 |
| 47 | | | | | 5x11 | 140 | 0.650 | 5x11 | 170 | 0.650 | 5x11 | 170 | 0.650 |
| 68 | | | | | 5x11 | 160 | 0.650 | 5x11 | 210 | 0.550 | 6.3x11 | 210 | 0.550 |
| 100 | | | | | 5x11 | 180 | 0.650 | 6.3x11 | 270 | 0.300 | 6.3x11 | 270 | 0.300 |
| 220 | | 6.3x11 | 270 | 0.300 | 6.3x11 | 295 | 0.300 | 8x12 | 520 | 0.200 | 8x12 | 550 | 0.200 |
| 330 | | 6.3x11 | 320 | 0.300 | 8x12 | 528 | 0.200 | 8x12 | 550 | 0.200 | 10x13 | 720 | 0.100 |
| 470 | | 8x12 | 528 | 0.200 | 8x12 | 550 | 0.200 | 10x13 | 720 | 0.100 | 10x16 | 850 | 0.075 |
| 680 | | 8x12 | 550 | 0.200 | 10x13 | 760 | 0.100 | 10x16 | 850 | 0.075 | 10x20 | 1200 | 0.058 |
| 1000 | | 10x13 | 780 | 0.100 | 10x16 | 875 | 0.075 | 10x20 | 1200 | 0.058 | 13x21 | 1450 | 0.055 |
| 1500 | | 10x16 | 950 | 0.075 | 10x20 | 1250 | 0.058 | 13x21 | 1450 | 0.055 | 13x25 | 1850 | 0.040 |
| 2200 | | 10x25 | 1420 | 0.055 | 13x21 | 1450 | 0.055 | 13x25 | 1850 | 0.043 | 16x26 | 2250 | 0.030 |
| 3300 | | 13x21 | 1550 | 0.055 | 13x25 | 1850 | 0.043 | 16x26 | 2250 | 0.030 | 16x32 | 2850 | 0.027 |
| 4700 | | 13x25 | 1950 | 0.035 | 16x26 | 2250 | 0.030 | 16x32 | 2850 | 0.027 | 18x35 | 3120 | 0.025 |
| 6800 | | 16x26 | 2460 | 0.030 | 16x32 | 2850 | 0.027 | 18x35 | 3120 | 0.025 | 18x40 | 3650 | 0.023 |
| 10000 | | 16x32 | 2890 | 0.027 | 18x35 | 3120 | 0.025 | 18x40 | 3650 | 0.023 | | | |
| 15000 | | 16x35 | 2950 | 0.025 | 18x40 | 3650 | 0.023 | | | | | | |

Aluminum Electrolytic Capacitors

RLA Series

Standard Ratings

D×L(mm) ; R.C.(mA rms) at 105°C 100KHz ; IMP (Ω max) at 20°C 100KHz.

| Cap (μF) | V | 35 | | | 50 | | | 63 | | | 100 | | |
|----------|------|--------|------|-------|--------|------|-------|--------|------|-------|--------|------|--------|
| | Item | D x L | R.C. | IMP | D x L | R.C. | IMP | D x L | R.C. | IMP | D x L | R.C. | IMP |
| 0.47 | | | | | 5x11 | 25 | 7.500 | | | | 5x11 | 20 | 15.000 |
| 1 | | | | | 5x11 | 40 | 5.300 | | | | 5x11 | 30 | 15.000 |
| 2.2 | | | | | 5x11 | 55 | 4.500 | | | | 5x11 | 44 | 9.800 |
| 3.3 | | | | | 5x11 | 65 | 3.900 | | | | 5x11 | 58 | 6.600 |
| 4.7 | | 5x11 | 85 | 2.000 | 5x11 | 90 | 2.300 | 5x11 | 65 | 4.494 | 5x11 | 74 | 4.600 |
| 10 | | 5x11 | 100 | 1.200 | 5x11 | 110 | 1.400 | 5x11 | 110 | 2.252 | 6.3x11 | 130 | 1.805 |
| 22 | | 5x11 | 120 | 1.000 | 5x11 | 140 | 1.200 | 6.3x11 | 200 | 1.000 | 8x12 | 280 | 1.360 |
| 33 | | 5x11 | 210 | 0.430 | 6.3x11 | 240 | 0.480 | 6.3x11 | 250 | 0.900 | 10x13 | 450 | 0.460 |
| 47 | | 6.3x11 | 270 | 0.300 | 6.3x11 | 240 | 0.480 | 8x12 | 420 | 0.800 | 10x16 | 650 | 0.390 |
| 68 | | 8x12 | 525 | 0.300 | 8x12 | 525 | 0.300 | 10x13 | 525 | 0.760 | 10x20 | 750 | 0.288 |
| 100 | | 8x12 | 550 | 0.200 | 8x12 | 550 | 0.250 | 10x13 | 550 | 0.580 | 13x21 | 950 | 0.208 |
| 220 | | 10x13 | 720 | 0.100 | 10x16 | 720 | 0.170 | 10x20 | 850 | 0.170 | 16x26 | 1250 | 0.104 |
| 330 | | 10x16 | 850 | 0.075 | 10x20 | 850 | 0.150 | 13x21 | 1250 | 0.142 | 16x32 | 1510 | 0.088 |
| 470 | | 10x20 | 1200 | 0.058 | 13x21 | 1450 | 0.090 | 13x25 | 1500 | 0.070 | 16x36 | 1720 | 0.072 |
| 680 | | 13x21 | 1450 | 0.055 | 13x25 | 1850 | 0.070 | 16x26 | 1780 | 0.055 | 18x35 | 1950 | 0.064 |
| 1000 | | 13x25 | 1850 | 0.043 | 16x26 | 2250 | 0.048 | 16x32 | 2120 | 0.043 | 18x40 | 2320 | 0.047 |
| 1500 | | 16x26 | 2250 | 0.030 | 16x32 | 2850 | 0.043 | 18x35 | 2310 | 0.033 | | | |
| 2200 | | 16x32 | 2850 | 0.027 | 18x35 | 3120 | 0.040 | 18x40 | 2540 | 0.032 | | | |
| 3300 | | 18x35 | 3120 | 0.025 | | | | | | | | | |
| 4700 | | 18x40 | 3650 | 0.023 | | | | | | | | | |

※13mm may be replaced by 12.5mm upon customer's request.

Standard Ratings

D×L(mm); R.C.(mA rms) at 105°C 100KHz ; IMP (Ω max)at 20°C 100KHz.

| Cap (Code) | V (Code) | 160 (2C) | | | 200 (2D) | | | 250(2E) | | |
|---------------|-------------|----------|------|------|----------|------|------|---------|------|------|
| | | D x L | R.C. | IMP | D x L | R.C. | IMP | D x L | R.C. | IMP |
| 2.2 | | | | | | | 8x12 | 105 | 13.0 | |
| 3.3 | | 8x12 | 104 | 11.0 | 8x12 | 113 | 11.0 | 8x12 | 122 | 11.0 |
| 4.7 | | 8x12 | 112 | 6.50 | 8x12 | 126 | 6.10 | 10x13 | 140 | 4.30 |
| 10 | | 10x13 | 180 | 4.30 | 10x13 | 210 | 3.80 | 10x16 | 300 | 3.50 |
| 22 | | 10x16 | 250 | 3.00 | 10x20 | 465 | 2.70 | 13x21 | 485 | 2.80 |
| 33 | | 10x20 | 570 | 1.90 | 10x25 | 600 | 1.40 | 13x21 | 620 | 2.13 |
| 47 | | 13x21 | 730 | 1.20 | 13x21 | 730 | 1.20 | 13x25 | 810 | 1.60 |
| 68 | | 13x21 | 850 | 0.86 | 13x25 | 985 | 0.70 | 16x26 | 1010 | 1.07 |
| 100 | | 16x26 | 1285 | 0.50 | 16x26 | 128 | 0.50 | 16x32 | 1405 | 0.62 |
| 220 | | 16x36 | 1450 | 0.29 | 18x32 | 1510 | 0.36 | 18x40 | 1490 | 0.38 |
| 330 | | 18x35 | 1850 | 0.26 | | | | | | |
| Cap (Code) | V (Code) | 400 | | | 450 | | | | | |
| | | D x L | R.C. | IMP | D x L | R.C. | IMP | | | |
| | | 6.3x12 | 50 | 27 | 8x12 | 60 | 28 | | | |
| 2.2 | | 8x12 | 80 | 13 | 10x13 | 90 | 23 | | | |
| | | 8x12 | 90 | 16.5 | 8x12 | 80 | 23 | | | |
| 3.3 | | 10x13 | 110 | 8.2 | 10x16 | 126 | 20 | | | |
| | | 8x12 | 90 | 9.5 | 8x14 | 95 | 12.5 | | | |
| 4.7 | | 10x16 | 160 | 4.8 | 10x20 | 170 | 6.2 | | | |
| | | 10x16 | 170 | 6.1 | 10x16 | 160 | 7.5 | | | |
| 10 | | 10x20 | 195 | 3.0 | 13x21 | 280 | 3.7 | | | |
| | | 13x21 | 290 | 4.0 | 13x21 | 280 | 7.0 | | | |
| 22 | | 13x25 | 350 | 1.95 | 16x26 | 580 | 3.5 | | | |
| | | 13x21 | 400 | 3.00 | 13x25 | 420 | 3.6 | | | |
| 33 | | 13x25 | 480 | 1.50 | 16x26 | 610 | 1.6 | | | |
| | | 13x25 | 530 | 1.25 | 16x26 | 650 | 1.9 | | | |
| 47 | | 16x26 | 720 | 0.61 | 16x32 | 850 | 0.85 | | | |
| | | 16x26 | 750 | 1.10 | 18x32 | | 0.71 | | | |
| 68 | | 16x32 | 820 | 0.55 | | 940 | | | | |
| | | 18x26 | 850 | 1.00 | 18x35 | 1000 | 1.00 | | | |
| 100 | | 18x35 | 950 | 0.48 | 18x40 | 1100 | 0.43 | | | |

※ 13mm may be replaced by 12.5mm upon customer's request.

RLB Series

- Low Impedance, high ripple current resistance, 2000~3000 hours load life.
- Suitable for output return circuit of switching power supply for IT products.
- RoHS Compliant & Halogen Free

Specifications

| Items | Characteristics | | | | | | | | | | | | |
|-----------------------------|--|---|------|------|------|------|--------------|--------|------|---------|------|---------|---|
| Capacitance Tolerance | ± 20% (120Hz, 20°C) | | | | | | | | | | | | |
| Operating Temperature Range | -40 ~ +105°C | | | | | | -25 ~ +105°C | | | | | | |
| Rated Voltage Range | 6.3 ~ 400VDC | | | | | | 450VDC | | | | | | |
| Leakage Current | $V \leq 100V$ $I \leq 0.01CV$ or 3 (μA) (After 2 minutes application of DC rated voltage, at 20°C) $V > 100V$ $I \leq 0.03CV + 20$ (μA) (After 5 minutes application of DC rated voltage, at 20°C) | | | | | | | | | | | | |
| Dissipation Factor | Measurement Frequency: 120Hz. Temperature: 20°C | | | | | | | | | | | | |
| | Rated Voltage(V) | 6.3 | 10 | 16 | 25 | 35 | 50 | 63 | 100 | 160~250 | 350 | 400~450 | |
| | tan δ(Max) | 0.15 | 0.12 | 0.10 | 0.09 | 0.08 | 0.07 | 0.08 | 0.08 | 0.15 | 0.20 | 0.25 | |
| Low Temperature Stability | Measurement Frequency: 120Hz. | | | | | | | | | | | | |
| | Rated Voltage(V) | 6.3 | 10 | 16 | 25 | 35 | 50 | 63~100 | | 160~350 | | 400~450 | |
| | Impedance Ratio (Max) | Z(-25°C)/Z(20°C) | | 4 | 3 | 2 | 2 | 2 | 2 | | 3 | | 6 |
| | Z(-40°C)/Z(20°C) | | 8 | 6 | 4 | 3 | 3 | 3 | | 6 | | 12 | |
| Load Life | The following specifications shall be satisfied when the capacitors are restored to 20°C after subjected to DC voltage with the rated ripple current is applied for 3,000 hours (ØD ≤ 8mm, 2,000 hrs) at 105°C | | | | | | | | | | | | |
| | Capacitance Change | Within ± 20% of Initial Value | | | | | | | | | | | |
| | tan δ | 200% or less of Initial Specified Value | | | | | | | | | | | |
| | Leakage Current | Initial Specified Value or less | | | | | | | | | | | |
| Shelf Life | The following specifications shall be satisfied when the capacitors are restored to 20°C after exposing them for 1,000 hours 105°C without voltage applied. Before the measurement, the capacitor shall be preconditioned by applying voltage according to them 4.1 of JIS C5101- 4. | | | | | | | | | | | | |
| | Capacitance Change | Within ± 20% of Initial Value | | | | | | | | | | | |
| | tan δ | 200% or less of Initial Specified Value | | | | | | | | | | | |
| | Leakage Current | Initial Specified Value or less | | | | | | | | | | | |
| Standards | JIS C 5101-4 (IEC 60384) | | | | | | | | | | | | |

Frequency Coefficient of Permissible Ripple Current

| Rated Voltage (V) | Capacitance (μF) | Frequency (Hz) | | | | |
|-------------------|------------------|----------------|------|------|------|------|
| | | 50 | 120 | 1K | 10K | 100K |
| 6.3 ~ 100 | 0.47 ~ 100 | 0.45 | 0.55 | 0.75 | 0.90 | 1.00 |
| | 220 ~ 1000 | 0.60 | 0.70 | 0.85 | 0.95 | 1.00 |
| | 1500 ~ 15000 | 0.70 | 0.80 | 0.95 | 0.98 | 1.00 |
| 160 ~ 450 | 2.2 ~ 330 | 0.55 | 0.65 | 0.80 | 0.90 | 1.00 |

The endurance of capacitors is reduced with internal heating produced by ripple current at the rate of halving the lifetime with every 5°C rise. When long life performance is required in actual use, the rms ripple current has to be reduced.

Dimensions (mm)

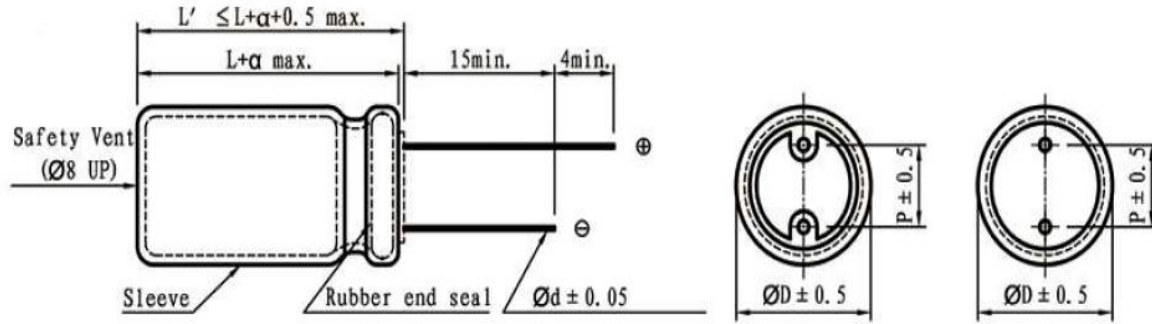

Standard Ratings

DxL(mm) ; R.C.(mA rms) at 105°C 100KHz ; IMP (Ω_{max}) at 20°C 100KHz.

| $\text{Ø}D$ | 5 | 6.3 | 8 | 10 | 13 | 16 | 18 | α | (L < 16) 1.0 | | | | |
|-------------|------|--------|------|-------|--------|------|-------|----------|--------------|-------|--------|------|-------|
| P | 2.0 | 2.5 | 3.5 | 5.0 | 5.0 | 7.5 | 7.5 | | (L ≥ 16) 2.0 | | | | |
| $\text{Ø}d$ | 0.5 | 0.5 | 0.5 | 0.6 | 0.6 | 0.8 | 0.8 | | | | | | |
| Ca P (µF) | V | 6.3 | | | 10 | | | 16 | | | 25 | | |
| | Item | DxL | R.C. | IMP | DxL | R.C. | IMP | DxL | R.C. | IMP | DxL | R.C. | IMP |
| 33 | | | | | | | | | | | 5x11 | 155 | 0.800 |
| 39 | | | | | | | | | | | 5x11 | 175 | 0.650 |
| 47 | | | | | | | | 5x11 | 155 | 0.800 | 6.3x11 | 210 | 0.550 |
| 56 | | | | | | | | 5x11 | 175 | 0.650 | 6.3x11 | 235 | 0.440 |
| 68 | | | | | 5x11 | 155 | 0.800 | 6.3x11 | 220 | 0.500 | 6.3x11 | 260 | 0.336 |
| 82 | | | | | 5x11 | 175 | 0.650 | 6.3x11 | 240 | 0.420 | 6.3x11 | 285 | 0.330 |
| 100 | | 5x11 | 200 | 0.620 | 6.3x11 | 200 | 0.420 | 6.3x11 | 255 | 0.370 | 8x12 | 520 | 0.220 |
| 220 | | 6.3x11 | 275 | 0.320 | 8x12 | 360 | 0.220 | 8x12 | 550 | 0.140 | 8x14 | 600 | 0.100 |
| 270 | | 6.3x11 | 320 | 0.250 | 8x12 | 420 | 0.185 | 8x16 | 650 | 0.140 | 8x20 | 750 | 0.095 |
| 330 | | 8x12 | 530 | 0.180 | 8x12 | 550 | 0.140 | 10x13 | 750 | 0.100 | 10x16 | 800 | 0.069 |
| 470 | | 10x13 | 750 | 0.140 | 10x13 | 750 | 0.100 | 10x16 | 800 | 0.085 | 10x20 | 1050 | 0.064 |
| 680 | | 10x16 | 950 | 0.100 | 10x16 | 800 | 0.085 | 10x20 | 1050 | 0.064 | 13x21 | 1370 | 0.049 |
| 1,000 | | 10x16 | 980 | 0.069 | 10x20 | 1080 | 0.065 | 13x21 | 1360 | 0.039 | 13x25 | 1600 | 0.038 |
| 2,200 | | 10x25 | 1450 | 0.043 | 13x25 | 1650 | 0.038 | 13x30 | 2050 | 0.028 | 13x40 | 2300 | 0.024 |
| 3,300 | | 13x25 | 1750 | 0.035 | 13x35 | 2100 | 0.028 | 13x40 | 2360 | 0.024 | 16x36 | 2600 | 0.019 |
| 3,900 | | 13x30 | 1910 | 0.034 | 13x40 | 2360 | 0.024 | 16x32 | 2470 | 0.022 | 16x40 | 2950 | 0.019 |
| 4,700 | | 13x35 | 2050 | 0.028 | 16x32 | 2370 | 0.024 | 16x36 | 2600 | 0.019 | 18x40 | 3500 | 0.019 |
| 6,800 | | 16x32 | 2300 | 0.024 | 16x36 | 2600 | 0.019 | 18x35 | 2850 | 0.019 | | | |
| 8,200 | | 16x36 | 2650 | 0.021 | 18x35 | 2900 | 0.019 | 18x40 | 3040 | 0.017 | | | |
| 10,000 | | 18x32 | 2850 | 0.019 | 18x40 | 3500 | 0.018 | | | | | | |
| 15,000 | | 18x40 | 3500 | 0.019 | | | | | | | | | |

※ 13mm may be replaced by 12.5mm upon customer's request.

Standard Ratings

DxL(mm) ; R.C.(mA rms) at 105°C 100KHz ; IMP (Ωmax)at 20°C 100KHz.

| Cap (μF) | V | 35 | | | 50 | | | 63 | | | 100 | | |
|----------|------|-------|------|-------|-------|------|-------|-------|------|-------|-------|------|-------|
| | Item | DxL | R.C. | IMP | DxL | R.C. | IMP | DxL | R.C. | IMP | DxL | R.C. | IMP |
| 47 | | | | | 8x12 | 350 | 0.350 | 8x12 | 450 | 0.300 | 10x25 | 850 | 0.350 |
| 68 | | 8x12 | 360 | 0.220 | 8x12 | 450 | 0.250 | 8x16 | 550 | 0.220 | 13x21 | 1100 | 0.240 |
| 100 | | 8x12 | 450 | 0.140 | 10x16 | 850 | 0.200 | 10x20 | 700 | 0.170 | 13x25 | 1250 | 0.180 |
| 220 | | 10x16 | 880 | 0.069 | 10x20 | 1100 | 0.100 | 13x21 | 1300 | 0.150 | 16x32 | 1850 | 0.071 |
| 330 | | 10x20 | 1100 | 0.044 | 13x21 | 1300 | 0.095 | 13x25 | 1400 | 0.070 | 18x40 | 2350 | 0.049 |
| 470 | | 13x21 | 1370 | 0.039 | 13x25 | 1450 | 0.070 | 13x35 | 1650 | 0.047 | | | |
| 680 | | 13x25 | 1600 | 0.038 | 13x35 | 1800 | 0.040 | 16x32 | 2000 | 0.037 | | | |
| 1000 | | 13x30 | 1930 | 0.029 | 16x32 | 2100 | 0.034 | 18x35 | 2200 | 0.034 | | | |
| 2200 | | 16x36 | 2550 | 0.019 | 18x40 | 2600 | 0.025 | | | | | | |
| 3300 | | 18x40 | 3150 | 0.019 | | | | | | | | | |

| Cap (μF) | V | 160 | | | 200 | | | 250 | | |
|----------|------|-------|------|------|-------|------|------|-------|------|------|
| | Item | DxL | R.C. | IMP | DxL | R.C. | IMP | DxL | R.C. | IMP |
| 2.2 | | | | | | | | 8x12 | 85 | 13.0 |
| 3.3 | | 8x12 | 85 | 11.0 | 8x12 | 90 | 11.0 | 8x12 | 97 | 11.0 |
| 4.7 | | 8x12 | 90 | 6.50 | 8x12 | 100 | 6.10 | 10x13 | 112 | 4.30 |
| 10 | | 10x13 | 144 | 4.30 | 10x13 | 168 | 3.80 | 10x16 | 240 | 3.50 |
| 22 | | 10x16 | 200 | 3.00 | 10x20 | 372 | 2.70 | 13x21 | 388 | 2.80 |
| 33 | | 10x20 | 450 | 2.50 | 10x25 | 480 | 2.30 | 13x21 | 495 | 2.20 |
| 47 | | 13x21 | 580 | 2.00 | 13x21 | 584 | 2.00 | 13x25 | 650 | 1.80 |
| 68 | | 13x21 | 680 | 1.05 | 13x25 | 788 | 0.98 | 16x26 | 810 | 0.90 |
| 100 | | 16x26 | 1028 | 0.90 | 16x26 | 1030 | 0.90 | 16x32 | 1124 | 0.85 |
| 220 | | 16x36 | 1160 | 0.80 | 18x32 | 1208 | 0.75 | 18x40 | 1200 | 0.70 |
| 330 | | 18x35 | 1480 | 0.70 | | | | | | |

| Cap (μF) | V | 400 | | | 450 | | |
|----------|------|-------|------|------|-------|------|------|
| | Item | DxL | R.C. | IMP | DxL | R.C. | IMP |
| 2.2 | | 8x12 | 65 | 7.60 | 10x13 | 75 | 9.50 |
| 3.3 | | 10x13 | 88 | 5.20 | 10x16 | 100 | 7.90 |
| 4.7 | | 10x16 | 128 | 3.85 | 10x20 | 115 | 6.20 |
| 10 | | 10x20 | 156 | 3.10 | 13x21 | 224 | 3.70 |
| 22 | | 13x25 | 280 | 2.10 | 16x26 | 460 | 1.00 |
| 33 | | 13x25 | 460 | 1.78 | 16x26 | 488 | 0.95 |
| 47 | | 16x26 | 580 | 1.36 | 16x32 | 680 | 0.85 |
| 68 | | 16x32 | 960 | 0.96 | 18x32 | 750 | 0.71 |
| 100 | | 18x35 | 1000 | 0.78 | 18x40 | 880 | 0.43 |

※ 13mm may be replaced by 12.5mm upon customer's request.

RLC Series

- Low Impedance, high reliability, 2000~5000 hours load life.
- Suitable for switching regulator of computer, etc.
- RoHS Compliant & Halogen Free

Specifications

| Items | Characteristics | | | | | | | | | | | | | |
|-----------------------------|--|---|------|------|------|------|------|--------------|------|---------|---------|------|---------|------|
| Capacitance Tolerance | ± 20% (120Hz, 20°C) | | | | | | | | | | | | | |
| Operating Temperature Range | -40 ~ +105°C | | | | | | | -25 ~ +105°C | | | | | | |
| Rated Voltage Range | 6.3 ~ 400VDC | | | | | | | 450VDC | | | | | | |
| Leakage Current | V ≤ 100V I ≤ 0.01CV or 3 (μA) (After 2 minutes application of DC rated voltage, at 20°C) V > 100V I ≤ 0.03CV +20 (μA) (After 5 minutes application of DC rated voltage, at 20°C) | | | | | | | | | | | | | |
| Dissipation Factor | Measurement Frequency: 120Hz. Temperature: 20°C | | | | | | | | | | | | | |
| | Rated Voltage (V) | 6.3 | 10 | 16 | 25 | 35 | 50 | 63 | 80 | 100 | 120~250 | 350 | 400~450 | 500 |
| | tan δ(Max) | 0.20 | 0.17 | 0.16 | 0.14 | 0.12 | 0.10 | 0.08 | 0.08 | 0.08 | 0.15 | 0.20 | 0.25 | 0.25 |
| Low Temperature Stability | Measurement Frequency: 120Hz. | | | | | | | | | | | | | |
| | Rated Voltage(V) | 6.3 | 10 | 16 | 25 | 35 | 50 | 63~100 | | 160~250 | 350~400 | | 450 | |
| Impedance Ratio (Max) | Z(-25°C)/Z(20°C) | 4 | 3 | 2 | 2 | 2 | 2 | 2 | | 3 | 6 | | 15 | |
| | Z(-40°C)/Z(20°C) | 8 | 6 | 4 | 3 | 3 | 3 | 3 | | 4 | 10 | | - | |
| Load Life | The following specifications shall be satisfied when the capacitors are restored to 20°C after subjected to DC voltage with the rated ripple current is applied for 5,000 hours (∅D ≤ 6.3:2,000 hrs , ψD ≤ 8.:3,000 hrs)at 105° | | | | | | | | | | | | | |
| | Capacitance Change | Within ± 20% of Initial Value | | | | | | | | | | | | |
| | tan δ | 200% or less of Initial Specified Value | | | | | | | | | | | | |
| | Leakage Current | Initial Specified Value or less | | | | | | | | | | | | |
| Shelf Life | The following specifications shall be satisfied when the capacitors are restored to 20°C after exposing them for 1,000 hours 105°C without voltage applied. Before the measurement the capacitor shall be preconditioned by applying voltage according to them 4.1 of JIS C5101-4. | | | | | | | | | | | | | |
| | Capacitance Change | Within ± 20% of Initial Value | | | | | | | | | | | | |
| | tan δ | 150% or less of Initial Specified Value | | | | | | | | | | | | |
| | Leakage Current | Initial Specified Value or less | | | | | | | | | | | | |
| Standards | JIS C 5101-4 (IEC 60384) | | | | | | | | | | | | | |

Frequency Coefficient of Permissible Ripple Current

| Rated Voltage (V) | Capacitance (μF) | Frequency (Hz) | | | | |
|-------------------|------------------|----------------|------|------|------|------|
| | | 50 | 120 | 1K | 10K | 100K |
| 6.3 ~ 100 | 10 ~ 150 | 0.60 | 0.70 | 0.85 | 0.95 | 1.00 |
| | 220 ~ 1800 | 0.65 | 0.75 | 0.90 | 0.98 | 1.00 |
| | 2200 ~ 15000 | 0.75 | 0.80 | 1.00 | 1.00 | 1.00 |
| 160 ~ 450 | 1 ~ 330 | 0.55 | 0.65 | 0.80 | 0.90 | 1.00 |

The endurance of capacitors is reduced with internal heating produced by ripple current at the rate of halving the lifetime with every 5°C rise. When long life performance is required in actual use, the RMS ripple current has to be reduced.

RLC Series

Dimensions (mm)

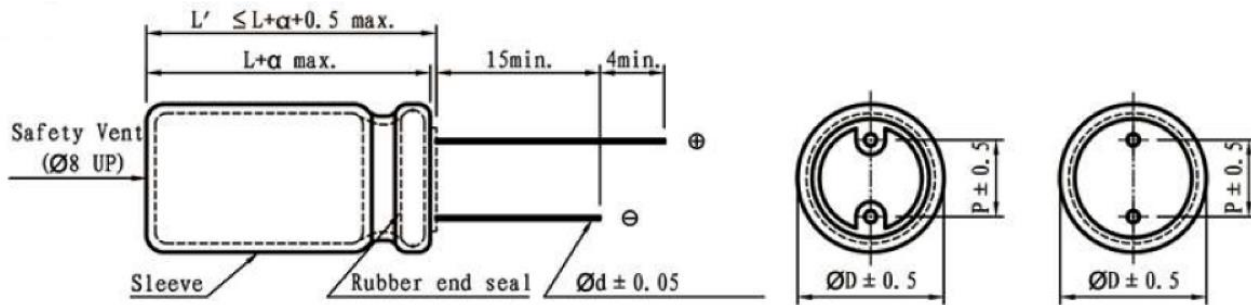

| | | | | | | | |
|-----|-----|-----|-----|-----|-----|-----|-----|
| Ø D | 5 | 6.3 | 8 | 10 | 13 | 16 | 18 |
| P | 2.0 | 2.5 | 3.5 | 5.0 | 5.0 | 7.5 | 7.5 |
| Ø d | 0.5 | 0.5 | 0.5 | 0.6 | 0.6 | 0.8 | 0.8 |

| | |
|----------|--------------|
| α | (L < 16) 1.0 |
| | (L ≥ 16) 2.0 |

Standard Ratings

DxL(mm) ; R.C.(mA rms) at 105°C 100KHz ; IMP (Ω max) at 20°C 100KHz.

| Cap (µF) | V | 6.3 | | | 10 | | | 16 | | | 25 | | |
|----------|---|--------|-------|-------|--------|-------|-------|-------|-------|-------|--------|-------|-------|
| | | Item | D x L | R.C. | IMP | D x L | R.C. | IMP | D x L | R.C. | IMP | D x L | R.C. |
| 33 | | | | | | | | | | | 5x11 | 145 | 0.920 |
| 47 | | | | | | | | 5x11 | 180 | 0.650 | 6.3x11 | 210 | 0.600 |
| 100 | | 5x11 | 140 | 0.920 | 5x11 | 180 | 0.650 | 5x11 | 230 | 0.550 | 6.3x11 | 370 | 0.350 |
| 220 | | 6.3x11 | 275 | 0.300 | 6.3x11 | 340 | 0.300 | 8x12 | 580 | 0.280 | 8x12 | 640 | 0.230 |
| 330 | | 6.3x11 | 320 | 0.300 | 8x12 | 580 | 0.280 | 8x12 | 640 | 0.230 | 10x13 | 865 | 0.080 |
| 470 | | 8x12 | 580 | 0.280 | 8x12 | 640 | 0.230 | 8x16 | 840 | 0.150 | 10x16 | 1210 | 0.060 |
| 560 | | 8x12 | 640 | 0.230 | 10x13 | 780 | 0.160 | 10x13 | 880 | 0.100 | 10x16 | 1320 | 0.055 |
| 680 | | 8x12 | 720 | 0.140 | 10x13 | 820 | 0.110 | 10x16 | 1000 | 0.085 | 10x20 | 1380 | 0.052 |
| 820 | | 8x16 | 840 | 0.087 | 8x16 | 865 | 0.080 | 10x16 | 1040 | 0.076 | 10x20 | 1400 | 0.046 |
| 1000 | | 10x13 | 865 | 0.080 | 10x16 | 1040 | 0.076 | 10x20 | 1210 | 0.060 | 13x21 | 1900 | 0.035 |
| 1200 | | 10x16 | 960 | 0.064 | 10x16 | 1210 | 0.060 | 10x25 | 1580 | 0.042 | 13x25 | 2058 | 0.032 |
| 1500 | | 10x16 | 1210 | 0.060 | 10x20 | 1400 | 0.058 | 13x21 | 1870 | 0.035 | 13x25 | 2124 | 0.030 |
| 1800 | | 10x20 | 1400 | 0.058 | 13x21 | 1580 | 0.042 | 13x21 | 1900 | 0.032 | 13x30 | 2340 | 0.028 |
| 2200 | | 10x25 | 1450 | 0.046 | 13x21 | 1900 | 0.032 | 13x25 | 2124 | 0.030 | 13x35 | 2450 | 0.026 |
| 2700 | | 13x21 | 1580 | 0.042 | 13x25 | 2124 | 0.030 | 13x30 | 2340 | 0.028 | 13x35 | 2743 | 0.024 |
| 3300 | | 13x21 | 1870 | 0.035 | 13x30 | 2340 | 0.028 | 13x35 | 2450 | 0.026 | 16x32 | 3029 | 0.022 |
| 3900 | | 13x21 | 1900 | 0.032 | 13x35 | 2450 | 0.026 | 16x26 | 2500 | 0.028 | 16x36 | 3124 | 0.020 |
| 4700 | | 13x25 | 2124 | 0.030 | 16x26 | 2500 | 0.028 | 16x32 | 3029 | 0.022 | 18x35 | 3638 | 0.019 |
| 5600 | | 13x30 | 2524 | 0.026 | 16x26 | 2552 | 0.026 | 16x36 | 3124 | 0.020 | 18x40 | 3781 | 0.016 |
| 6800 | | 16x26 | 2760 | 0.028 | 16x32 | 3029 | 0.022 | 16x40 | 3586 | 0.019 | | | |
| 8200 | | 16x32 | 3029 | 0.022 | 16x32 | 3600 | 0.020 | 18x35 | 3750 | 0.018 | | | |
| 10000 | | 16x36 | 3124 | 0.020 | 18x35 | 3638 | 0.019 | | | | | | |
| 12000 | | 18x32 | 3600 | 0.020 | | | | | | | | | |
| 15000 | | 18x35 | 3781 | 0.018 | | | | | | | | | |

※13mm may be replaced by 12.5mm upon customer's request.

RLC Series

Standard Ratings

DxL(mm); R.C. (mA rms) at 105°C 100KHz ; IMP (Ω max) at 20°C 100KHz.

| Cap (μF) | V | | 35 | | | 50 | | | 63 | | | 100 | | |
|----------|------|--------|------|-------|--------|------|-------|--------|------|-------|--------|------|-------|--|
| | Item | D x L | R.C. | IMP | D x L | R.C. | IMP | D x L | R.C. | IMP | D x L | R.C. | IMP | |
| 10 | | | | | 5x11 | 120 | 1.400 | 5x11 | 125 | 1.650 | 6.3x11 | 130 | 1.250 | |
| 22 | | 5x11 | 150 | 0.920 | 5x11 | 160 | 1.200 | 6.3x11 | 240 | 0.780 | 8x12 | 230 | 0.850 | |
| 33 | | 5x11 | 220 | 0.430 | 6.3x11 | 230 | 0.300 | 8x12 | 270 | 0.650 | 10x13 | 330 | 0.690 | |
| 47 | | 6.3x11 | 280 | 0.300 | 6.3x11 | 295 | 0.300 | 8x12 | 300 | 0.504 | 10x13 | 370 | 0.450 | |
| 100 | | 8x12 | 450 | 0.200 | 10x13 | 760 | 0.120 | 10x16 | 610 | 0.160 | 10x25 | 560 | 0.300 | |
| 220 | | 10x13 | 760 | 0.100 | 10x16 | 1150 | 0.078 | 10x20 | 1100 | 0.120 | 13x25 | 880 | 0.280 | |
| 330 | | 10x16 | 1210 | 0.060 | 13x21 | 1660 | 0.055 | 13x21 | 1280 | 0.100 | 16x26 | 1440 | 0.130 | |
| 470 | | 10x20 | 1400 | 0.058 | 13x25 | 1950 | 0.046 | 13x25 | 1710 | 0.082 | 18x32 | 1690 | 0.110 | |
| 560 | | 13x21 | 1660 | 0.055 | 13x25 | 2124 | 0.034 | 16x26 | 1820 | 0.058 | 18x35 | 2020 | 0.043 | |
| 680 | | 13x21 | 1900 | 0.035 | 13x30 | 2310 | 0.030 | 16x26 | 1850 | 0.055 | 18x35 | 2100 | 0.043 | |
| 820 | | 13x25 | 2124 | 0.030 | 13x35 | 2510 | 0.025 | 16x32 | 2250 | 0.043 | | | | |
| 1000 | | 13x25 | 2340 | 0.028 | 13x35 | 2920 | 0.022 | 16x36 | 2450 | 0.036 | | | | |
| 1200 | | 13x30 | 2524 | 0.026 | 16x32 | 3010 | 0.022 | 18x32 | 2580 | 0.031 | | | | |
| 1500 | | 16x26 | 2600 | 0.026 | 16x36 | 3150 | 0.020 | | | | | | | |
| 1800 | | 16x26 | 2850 | 0.025 | 18x32 | 3635 | 0.020 | | | | | | | |
| 2200 | | 16x32 | 3029 | 0.022 | 18x35 | 3680 | 0.017 | | | | | | | |
| 2700 | | 18x32 | 3600 | 0.020 | | | | | | | | | | |
| 3300 | | 18x40 | 3781 | 0.015 | | | | | | | | | | |

| Cap (μF) | V | | 160 | | 200 | | 250 | |
|----------|------|-------|------|-------|------|-------|------|--|
| | Item | D x L | R.C. | D x L | R.C. | D x L | R.C. | |
| 4.7 | | | | | | 8x12 | 150 | |
| 10 | | 10x16 | 330 | 10x16 | 330 | 10x16 | 330 | |
| 22 | | 10x20 | 510 | 10x20 | 510 | 10x20 | 510 | |
| 33 | | 10x20 | 650 | 10x20 | 650 | 13x21 | 800 | |
| 47 | | 10x20 | 750 | 13x21 | 980 | 13x21 | 980 | |
| 100 | | 13x25 | 1420 | 16x25 | 1580 | 16x32 | 1750 | |
| 150 | | 16x25 | 1900 | 16x25 | 1900 | 18x32 | 2050 | |
| 330 | | 18x25 | 2100 | 18x32 | 2300 | | | |

| Cap (μF) | V | | 350 | | 400 | | 450 | |
|----------|------|-------|------|-------|------|-------|------|--|
| | Item | D x L | R.C. | D x L | R.C. | D x L | R.C. | |
| 2.2 | | | | 10x13 | 150 | | | |
| 3.3 | | | | 10x13 | 160 | | | |
| 4.7 | | 10x13 | 140 | 10x16 | 230 | 10x20 | 210 | |
| 10 | | 10x20 | 350 | 10x20 | 350 | 13x21 | 450 | |
| 22 | | 13x21 | 640 | 13x21 | 640 | 16x22 | 750 | |
| 33 | | 16x22 | 850 | 16x22 | 850 | 16x25 | 950 | |
| 47 | | 16x25 | 1030 | 16x25 | 1030 | 18x25 | 1050 | |
| 100 | | 16x32 | 1180 | 18x32 | 1180 | 18x35 | 1230 | |

※13mm may be replaced by 12.5mm upon customer's request.

RLD Series

- Ultra-Low impedance at High frequency range.
- High ripple current, 105°C 4000~8000 hours long life.
- RoHS Compliant & Halogen Free

Specifications

| Items | Characteristics | | | | | | | | | |
|--|--|---|------|------|------|------|---------|---------|------|--|
| Capacitance Tolerance | ± 20% (120Hz, 20°C) | | | | | | | | | |
| Operating Temperature Range | -40 ~ +105°C | | | | | | | | | |
| Rated Voltage Range | 6.3 ~ 100VDC | | | | | | | | | |
| Leakage Current | $I \leq 0.01CV$ or 3 (μA) which is greater. (After 2 minutes application of DC rated voltage, at 20 °C) | | | | | | | | | |
| Dissipation Factor | Measurement Frequency: 120Hz. Temperature: 20°C | | | | | | | | | |
| | Rated Voltage (V) | 6.3 | 10 | 16 | 25 | 35 | 50 | 63 | 100 | |
| | tan δ(Max) | 0.22 | 0.19 | 0.16 | 0.14 | 0.12 | 0.10 | 0.09 | 0.08 | |
| When nominal capacitance over 1000μF, tan δ shall be added 0.02 to the listed value with increase of every 1000μF. | | | | | | | | | | |
| Low Temperature Stability | Measurement Frequency: 120Hz. | | | | | | | | | |
| | Rated Voltage(V) | 6.3 | 10 | 16 | 25 | 35 | 50 | 63 | 100 | |
| | Z(-25°C) / Z(20°C) | 4 | 3 | 2 | 2 | 2 | 2 | 2 | 2 | |
| Impedance Ratio (Max) | Z(-40°C) / Z(20°C) | 8 | 6 | 4 | 3 | 3 | 3 | 3 | 3 | |
| | Refer the | | | | | | | | | |
| The following specifications shall be satisfied when the capacitors are restored to 20°C after subjected to DC voltage with the rated ripple current is applied for Varied hours according to varied ψ (Please refer to below sheet) at 105° | | | | | | | | | | |
| Refer the | Time | ψ | 5 | 6.3 | 8 | 10 | 12.5~13 | 14.5~16 | 18 | |
| | | Hours | 4000 | 4000 | 5000 | 6000 | 7000 | 8000 | 8000 | |
| | Capacitance Change | Within ± 20% of Initial Value | | | | | | | | |
| | tan δ | 200% or less of Initial Specified Value | | | | | | | | |
| | Leakage Current | Initial Specified Value or less | | | | | | | | |
| Shelf Life | The following specifications shall be satisfied when the capacitors are restored to 20°C after exposing them for 1,000 hours 105°C without voltage applied. Before the measurement the capacitor shall be preconditioned by applying voltage according to them 4.1 of JIS C5101-4. | | | | | | | | | |
| | Capacitance Change | Within ± 20% of Initial Value | | | | | | | | |
| | tan δ | 200% or less of Initial Specified Value | | | | | | | | |
| | Leakage Current | Initial Specified Value or less | | | | | | | | |
| Standards | JIS C 5101-4 (IEC 60384) | | | | | | | | | |

Frequency Coefficient of Permissible Ripple Current

| Capacitance (μF) | Frequency (Hz) | | | |
|------------------|----------------|------|------|------|
| | 120 | 1K | 10K | 100K |
| 5.6 ~ 180 | 0.40 | 0.75 | 0.90 | 1.00 |
| 220 ~ 560 | 0.50 | 0.85 | 0.94 | 1.00 |
| 680 ~ 1800 | 0.60 | 0.87 | 0.95 | 1.00 |
| 2200 ~ 3900 | 0.75 | 0.90 | 0.95 | 1.00 |
| 4700 ~ 18000 | 0.85 | 0.95 | 0.98 | 1.00 |

The endurance of capacitors is reduced with internal heating produced by ripple current at the rate of halving the lifetime with every 5°C rise. When long life performance is required in actual use, the RMS ripple current has to be reduced.

RLD Series

Dimensions (mm)

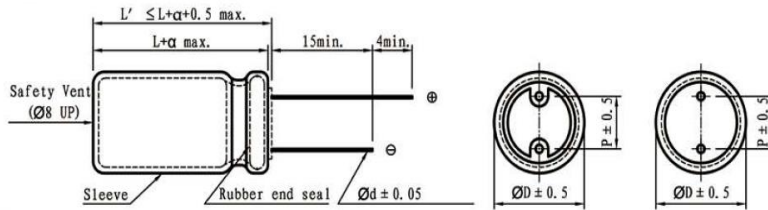

| | | | | | | | |
|-----|-----|-----|-----|-----|-----|-----|-----|
| Ø D | 5 | 6.3 | 8 | 10 | 13 | 16 | 18 |
| P | 2.0 | 2.5 | 3.5 | 5.0 | 5.0 | 7.5 | 7.5 |
| Ø d | 0.5 | 0.5 | 0.5 | 0.6 | 0.6 | 0.8 | 0.8 |

| | |
|----------|--------------|
| α | (L < 16) 1.0 |
| | (L ≥ 16) 2.0 |

Standard Ratings

DxL(mm); R.C. (mA rms) at 105°C 100KHz ; IMP (Ω max) at 20°C,-10°C 100KHz.

| Cap (µF) | V | 6.3 | | | 10 | | | 16 | | | 25 | | | | | | |
|----------|---|--------|-------|-------|------|--------|-------|-------|--------|--------|-------|-------|--------|-------|-------|-------|------|
| | | D x L | IMP | | R.C. | D x L | IMP | | R.C. | D x L | IMP | | R.C. | | | | |
| | | | 20°C | -10°C | | | 20°C | -10°C | | | 20°C | -10°C | | | | | |
| 47 | | | | | | | | 5x11 | 0.500 | 1.000 | 170 | 5x11 | 0.490 | 1.000 | 175 | | |
| 100 | | | | | 5x11 | 0.500 | 1.000 | 170 | 6.3x11 | 0.250 | 0.500 | 295 | 6.3x11 | 0.250 | 0.500 | 295 | |
| 150 | | 5x11 | 0.500 | 1.000 | 170 | | | | 6.3x15 | 0.170 | 0.360 | 410 | 6.3x15 | 0.180 | 0.350 | 420 | |
| 220 | | | | | | 6.3x11 | 0.240 | 0.500 | 295 | 6.3x15 | 0.170 | 0.360 | 410 | 8x12 | 0.120 | 0.240 | 650 |
| 330 | | 6.3x11 | 0.240 | 0.500 | 295 | 6.3x15 | 0.180 | 0.350 | 400 | 8x12 | 0.120 | 0.230 | 660 | 8x16 | 0.090 | 0.180 | 750 |
| 390 | | | | | | | | | | | | | 10x13 | 0.090 | 0.180 | 770 | |
| 470 | | 6.3x15 | 0.180 | 0.360 | 400 | 8x12 | 0.120 | 0.230 | 650 | 8x20 | 0.079 | 0.150 | 820 | 8x20 | 0.079 | 0.150 | 820 |
| 560 | | | | | | | | | | 8x16 | 0.089 | 0.180 | 740 | 10x16 | 0.067 | 0.136 | 1060 |
| 680 | | 8x12 | 0.120 | 0.240 | 655 | 8x16 | 0.090 | 0.180 | 830 | 10x13 | 0.090 | 0.180 | 770 | 10x16 | 0.067 | 0.136 | 1070 |
| 820 | | 10x13 | 0.091 | 0.180 | 860 | 10x13 | 0.090 | 0.180 | 860 | 8x20 | 0.080 | 0.160 | 830 | 10x20 | 0.052 | 0.104 | 1230 |
| 1000 | | 8x16 | 0.091 | 0.190 | 830 | 8x20 | 0.080 | 0.150 | 1010 | 10x16 | 0.067 | 0.136 | 1250 | 10x20 | 0.052 | 0.103 | 1270 |
| 1200 | | 8x20 | 0.082 | 0.170 | 1060 | 10x20 | 0.052 | 0.103 | 1420 | 10x25 | 0.045 | 0.090 | 1450 | 10x30 | 0.037 | 0.073 | 1720 |
| 1500 | | 10x16 | 0.067 | 0.136 | 1250 | 10x16 | 0.067 | 0.136 | 1250 | 13x21 | 0.037 | 0.076 | 1670 | 13x21 | 0.037 | 0.076 | 1670 |
| 1800 | | 10x20 | 0.051 | 0.103 | 1420 | 10x25 | 0.044 | 0.090 | 1640 | 10x30 | 0.036 | 0.074 | 1700 | 13x25 | 0.030 | 0.060 | 1960 |
| 2200 | | | | | | 10x30 | 0.036 | 0.074 | 1930 | 13x21 | 0.038 | 0.077 | 1650 | 13x21 | 0.038 | 0.077 | 1650 |
| 2700 | | 10x25 | 0.044 | 0.090 | 1640 | 13x21 | 0.038 | 0.077 | 1650 | 13x25 | 0.030 | 0.060 | 1960 | 13x25 | 0.030 | 0.060 | 1960 |
| 3300 | | 10x30 | 0.038 | 0.075 | 1930 | | | | | 13x30 | 0.024 | 0.050 | 2330 | 13x30 | 0.024 | 0.050 | 2320 |
| 3900 | | 13x21 | 0.037 | 0.075 | 1650 | 13x25 | 0.030 | 0.060 | 1960 | 16x22 | 0.028 | 0.058 | 2220 | 16x22 | 0.029 | 0.068 | 2220 |
| 4700 | | | | | | 13x30 | 0.024 | 0.050 | 2320 | 13x35 | 0.022 | 0.043 | 2520 | 13x35 | 0.022 | 0.043 | 2520 |
| 5600 | | 13x35 | 0.021 | 0.043 | 2520 | 13x40 | 0.017 | 0.034 | 2880 | 16x26 | 0.022 | 0.043 | 2570 | 16x26 | 0.022 | 0.043 | 2570 |
| 6300 | | 16x22 | 0.028 | 0.057 | 2230 | 16x22 | 0.028 | 0.058 | 2230 | 18x20 | 0.028 | 0.055 | 2490 | 18x20 | 0.027 | 0.055 | 2490 |
| 6800 | | | | | | 18x20 | 0.027 | 0.056 | 2490 | 18x25 | 0.020 | 0.040 | 2750 | 18x25 | 0.020 | 0.040 | 2750 |
| 8200 | | 13x40 | 0.017 | 0.034 | 2880 | 16x32 | 0.018 | 0.038 | 3020 | 16x36 | 0.017 | 0.034 | 3160 | 16x36 | 0.017 | 0.033 | 3140 |
| 10000 | | 16x26 | 0.022 | 0.043 | 2570 | 18x25 | 0.020 | 0.040 | 2750 | 18x32 | 0.017 | 0.035 | 3350 | 18x32 | 0.018 | 0.035 | 3340 |
| 12000 | | 18x20 | 0.027 | 0.055 | 2490 | 16x36 | 0.017 | 0.034 | 3150 | 18x35 | 0.016 | 0.032 | 3670 | 18x35 | 0.016 | 0.032 | 3670 |
| 15000 | | 16x32 | 0.019 | 0.038 | 3020 | 18x32 | 0.017 | 0.036 | 3340 | 18x40 | 0.015 | 0.030 | 3810 | 18x40 | 0.015 | 0.030 | 3810 |
| 18000 | | 16x36 | 0.016 | 0.033 | 3150 | 16x40 | 0.015 | 0.030 | 3720 | | | | | | | | |
| | | 18x25 | 0.020 | 0.040 | 2750 | 18x35 | 0.016 | 0.031 | 3670 | | | | | | | | |
| | | 16x40 | 0.015 | 0.030 | 3720 | 18x40 | 0.015 | 0.030 | 3810 | | | | | | | | |
| | | 18x32 | 0.017 | 0.035 | 3340 | | | | | | | | | | | | |
| | | 18x35 | 0.016 | 0.031 | 3670 | | | | | | | | | | | | |
| | | 18x40 | 0.015 | 0.030 | 3810 | | | | | | | | | | | | |

※ 13mm may be replaced by 12.5mm upon customer's request.

RLE Series

- High ripple current, ultra-low impedance at high frequency range.
- Long life.
- RoHS Compliant & Halogen Free

Specifications

| Items | Characteristics | | | | | | |
|--|---|---|------|------|------|------|------|
| Capacitance Tolerance | ± 20% (120Hz, 20°C) | | | | | | |
| Operating Temperature Range | -40 ~ +105°C | | | | | | |
| Rated Voltage Range | 6.3 ~ 50VDC | | | | | | |
| Leakage Current | $I \leq 0.01CV$ or 3 (μA) which is greater. (After 2 minutes application of DC rated voltage, at 20 °C) | | | | | | |
| Dissipation Factor | Measurement Frequency: 120Hz. Temperature: 20°C | | | | | | |
| | Rated Voltage (V) | 6.3 | 10 | 16 | 25 | 35 | 50 |
| | tan δ(Max) | 0.22 | 0.19 | 0.16 | 0.14 | 0.12 | 0.10 |
| When nominal capacitance over 1000μF, tan δ shall be added 0.02 to the listed value with increase of every 1000μF. | | | | | | | |
| Low Temperature Stability | Measurement Frequency: 120Hz. | | | | | | |
| | Rated Voltage(V) | 6.3 | 10 | 16 | 25 | 35 | 50 |
| | Z(-25°C) / Z(20°C) | 2 | 2 | 2 | 2 | 2 | 2 |
| Impedance Ratio (Max) | Z(-40°C) / Z(20°C) | 3 | 3 | 3 | 3 | 3 | 3 |
| | 5000hours, with application of rated voltage at 105°C (ψD ≤ 6.3mm, 2,000 hrs ; ψD = 8mm, 3,000 hrs ; ψD = 10mm, 4,000 hrs) | | | | | | |
| Load Life | Capacitance Change | Within ± 20% of Initial Value | | | | | |
| | tan δ | 200% or less of Initial Specified Value | | | | | |
| | Leakage Current | Initial Specified Value or less | | | | | |
| Shelf Life | The following specifications shall be satisfied when the capacitors are restored to 20°C after exposing them for 1,000 hours 105°C without voltage applied. Before the measurement, the capacitor shall be preconditioned by applying voltage according to them 4.1 of JIS C5101-4. | | | | | | |
| | Capacitance Change | Within ± 20% of Initial Value | | | | | |
| | tan δ | 200% or less of Initial Specified Value | | | | | |
| Leakage Current | Initial Specified Value or less | | | | | | |
| | Standards | | | | | | |
| JIS C 5101-4 (IEC 60384) | | | | | | | |

Frequency Coefficient of Permissible Ripple Current

| Capacitance (μF) | Frequency (Hz) | | | | |
|------------------|----------------|------|------|------|------|
| | 50 | 120 | 1K | 10K | 100K |
| ≤ 33 | 0.34 | 0.40 | 0.75 | 0.90 | 1.00 |
| 47 ~ 330 | 0.45 | 0.50 | 0.85 | 0.95 | 1.00 |
| 470 ~ 1000 | 0.50 | 0.60 | 0.90 | 0.95 | 1.00 |
| 1200 ~ 6800 | 0.65 | 0.80 | 0.95 | 0.95 | 1.00 |

The endurance of capacitors is reduced with internal heating produced by ripple current at the rate of halving the lifetime with every 5°C rise. When long life performance is required in actual use, the RMS ripple current has to be reduced.

RLE Series

Dimensions (mm)

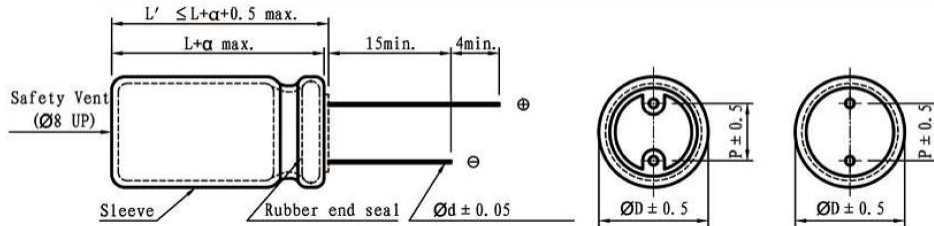

| | | | | | | |
|-----|-----|-----|-----|-----|-----|-----|
| Ø D | 5 | 6.3 | 8 | 10 | 13 | 16 |
| P | 2.0 | 2.5 | 3.5 | 5.0 | 5.0 | 7.5 |
| Ø d | 0.5 | 0.5 | 0.5 | 0.6 | 0.6 | 0.8 |

| | |
|---|--------------|
| α | (L < 16) 1.0 |
| | (L ≥ 16) 2.0 |

Standard Ratings

DxL(mm); R.C. (mA rms) at 105°C 100KHz ; IMP (Ω max) at 20°C 100KHz.

| Cap Value | V | 6.3 | | | 10 | | | 16 | | |
|--------------|---|--------|-------|-------|--------|-------|-------|--------|-------|-------|
| | | Item | D x L | R.C. | IMP | D x L | R.C. | IMP | D x L | R.C. |
| 56 | | | | | | | | 5x11 | 250 | 0.300 |
| 100 | | | | | 5x11 | 250 | 0.300 | | | |
| 120 | | | | | | | | 6.3x11 | 405 | 0.130 |
| 150 | | 5x11 | 250 | 0.300 | | | | | | |
| 220 | | | | | 6.3x11 | 405 | 0.130 | | | |
| 330 | | 6.3x11 | 405 | 0.130 | 8x12 | 600 | 0.085 | 8x12 | 760 | 0.072 |
| 470 | | | | | 8x12 | 760 | 0.072 | 8x16 | 995 | 0.056 |
| | | | | | | | | 10x13 | 1030 | 0.053 |
| 560 | | 8x12 | 760 | 0.072 | | | | | | |
| 680 | | | | | 8x16 | 995 | 0.056 | 8x20 | 1250 | 0.041 |
| | | | | | 10x13 | 1030 | 0.053 | 10x16 | 1430 | 0.038 |
| 820 | | 8x16 | 995 | 0.056 | | | | | | |
| 1000 | | 10x13 | 1030 | 0.053 | 8x20 | 1250 | 0.041 | 10x20 | 1820 | 0.023 |
| | | | | | 10x16 | 1430 | 0.038 | | | |
| 1200 | | 8x20 | 1250 | 0.041 | 10x20 | 1820 | 0.023 | 10x25 | 2150 | 0.022 |
| | | 10x16 | 1430 | 0.038 | | | | | | |
| 1500 | | 10x20 | 1820 | 0.023 | 10x25 | 2150 | 0.022 | 13x21 | 2360 | 0.021 |
| 2200 | | 10x25 | 2150 | 0.022 | 13x21 | 2360 | 0.021 | 13x25 | 2770 | 0.018 |
| 2700 | | | | | | | | 13x30 | 3140 | 0.016 |
| | | | | | | | | 16x22 | 3290 | 0.018 |
| 3300 | | 13x21 | 2360 | 0.021 | 13x25 | 2770 | 0.018 | 13x35 | 3400 | 0.015 |
| 3900 | | 13x25 | 2770 | 0.018 | 13x30 | 3290 | 0.016 | 16x26 | 3460 | 0.016 |
| | | | | | 16x22 | 3140 | 0.018 | | | |
| 4700 | | 13x30 | 3290 | 0.016 | 13x35 | 3400 | 0.015 | | | |
| 5600 | | 13x35 | 3350 | 0.015 | 16x26 | 3460 | 0.016 | | | |
| | | 16x22 | 3400 | 0.018 | | | | | | |
| 6800 | | 16x26 | 3460 | 0.016 | | | | | | |

※13mm may be replaced by 12.5mm upon customer's request.

Aluminum Electrolytic Capacitors
RLE Series

Standard Ratings

DxL(mm); R.C. (mA rms) at 105°C 100KHz; IMP (Ω max) at 20°C 100KHz.

| Cap (μF) | V | 25 | | | 35 | | | 50 | | |
|-------------|------|--------|------|-------|--------|------|-------|--------|------|-------|
| | Item | D x L | R.C. | IMP | D x L | R.C. | IMP | D x L | R.C. | IMP |
| 22 | | | | | | | | 5x11 | 238 | 0.340 |
| 33 | | | | | 5x11 | 250 | 0.300 | | | |
| 47 | | 5x11 | 250 | 0.300 | | | | | | |
| 56 | | | | | 6.3x11 | 405 | 0.130 | 6.3x11 | 385 | 0.140 |
| 68 | | | | | | | | | | |
| 100 | | 6.3x11 | 405 | 0.130 | | | | 8x12 | 724 | 0.074 |
| 120 | | | | | | | | 8x16 | 950 | 0.061 |
| 150 | | | | | 8x12 | 760 | 0.072 | 10x13 | 979 | 0.061 |
| 180 | | | | | | | | 8x20 | 1190 | 0.046 |
| 220 | | 8x12 | 760 | 0.072 | 8x16 | 995 | 0.056 | 10x16 | 1370 | 0.042 |
| | | | | | 10x13 | 1030 | 0.053 | | | |
| 270 | | | | | 8x20 | 1250 | 0.041 | 10x20 | 1580 | 0.030 |
| 330 | | 8x16 | 995 | 0.056 | 10x16 | 1430 | 0.038 | 10x25 | 1870 | 0.028 |
| | | 10x13 | 1030 | 0.053 | | | | | | |
| 470 | | 8x20 | 1250 | 0.041 | 10x20 | 1820 | 0.023 | 13x21 | 2050 | 0.027 |
| | | 10x16 | 1430 | 0.038 | | | | | | |
| 560 | | | | | 10x25 | 2150 | 0.022 | 13x25 | 2410 | 0.023 |
| 680 | | 10x20 | 1820 | 0.023 | 13x21 | 2360 | 0.021 | 13x30 | 2860 | 0.021 |
| 820 | | 10x25 | 2150 | 0.022 | 13x21 | 2450 | 0.020 | 13x35 | 2960 | 0.019 |
| | | | | | | | | 16x22 | 2730 | 0.023 |
| 1000 | | 13x21 | 2360 | 0.021 | 13x25 | 2770 | 0.018 | 16x26 | 3010 | 0.021 |
| 1200 | | 13x21 | 2360 | 0.021 | 13x30 | 3140 | 0.016 | | | |
| | | | | | 16x22 | 3290 | 0.018 | | | |
| 1500 | | 13x25 | 2770 | 0.018 | 13x35 | 3400 | 0.015 | | | |
| 1800 | | 13x30 | 3140 | 0.016 | 16x26 | 3460 | 0.016 | | | |
| | | 16x22 | 3290 | 0.018 | | | | | | |
| 2200 | | 13x35 | 3400 | 0.015 | | | | | | |
| 2700 | | 16x26 | 3460 | 0.016 | | | | | | |

※13mm may be replaced by 12.5mm upon customer's request.

RLF Series

- Low impedance at high frequency range.
- Smaller case size and high ripple current.
- RoHS Compliant & Halogen Free

Specifications

| Items | Characteristics | | | | | | |
|-----------------------------|--|---|------|------|------|------|--------|
| Capacitance Tolerance | ± 20% (120Hz, 20°C) | | | | | | |
| Operating Temperature Range | -40 ~ +105°C | | | | | | |
| Rated Voltage Range | 6.3 ~ 35VDC | | | | | | |
| Leakage Current | $I \leq 0.01CV$ or 3 (μA) which is greater. (After 2 minutes application of DC rated voltage, at 20 °C) | | | | | | |
| Dissipation Factor | Measurement Frequency: 120Hz. Temperature: 20°C | | | | | | |
| | Rated Voltage (V) | 6.3 | 10 | 16 | 25 | 35 | 50~100 |
| | tan δ(Max) | 0.21 | 0.18 | 0.15 | 0.13 | 0.11 | 0.09 |
| | When nominal capacitance over 1000μF, tan δ shall be added 0.02 to the listed value with increase of every 1000μF. | | | | | | |
| Low Temperature Stability | Measurement Frequency: 120Hz. | | | | | | |
| | Rated Voltage(V) | 6.3 | 10 | 16 | 25 | 35 | |
| | Z(-25°C) / Z(20°C) | 2 | 2 | 2 | 2 | 2 | |
| Impedance Ratio (Max) | Z(-40°C) / Z(20°C) | 3 | 3 | 3 | 3 | 3 | |
| | | | | | | | |
| Load Life | 6000hours, with application of rated voltage at 105°C (∅D≤6.3, 5000hrs) | | | | | | |
| | Capacitance Change | Within ± 25% of Initial Value | | | | | |
| | tan δ | 200% or less of Initial Specified Value | | | | | |
| | Leakage Current | Initial Specified Value or less | | | | | |
| Shelf Life | The following specifications shall be satisfied when the capacitors are restored to 20°C after exposing them for 1,000 hours 105°C without voltage applied. Before the measurement the capacitor shall be preconditioned by applying voltage according to them 4.1 of JIS C5101-4. | | | | | | |
| | Capacitance Change | Within ± 20% of Initial Value | | | | | |
| | tan δ | 200% or less of Initial Specified Value | | | | | |
| | Leakage Current | Initial Specified Value or less | | | | | |
| Standards | JIS C 5101-4 (IEC 60384) | | | | | | |

Frequency Coefficient of Permissible Ripple Current

| Capacitance (μF) | Frequency (Hz) | | | |
|------------------|----------------|------|------|------|
| | 120 | 1K | 10K | 100K |
| 47 ~ 150 | 0.40 | 0.75 | 0.90 | 1.00 |
| 220 ~ 560 | 0.50 | 0.85 | 0.94 | 1.00 |
| 680 ~ 1800 | 0.60 | 0.87 | 0.95 | 1.00 |
| 2200 ~ 3900 | 0.75 | 0.90 | 0.95 | 1.00 |
| 4700 ~ 8200 | 0.85 | 0.95 | 0.98 | 1.00 |

The endurance of capacitors is reduced with internal heating produced by ripple current at the rate of halving the lifetime with every 5°C rise. When long life performance is required in actual use, the RMS ripple current has to be reduced.

RLF Series

Dimensions (mm)

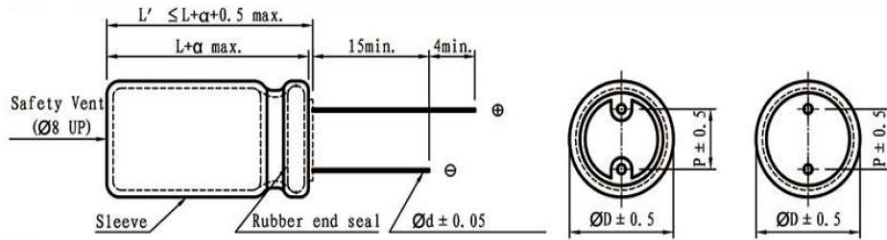

| | | | | | | |
|-----|-----|-----|-----|-----|-----|-----|
| Ø D | 5 | 6.3 | 8 | 10 | 13 | 16 |
| P | 2.0 | 2.5 | 3.5 | 5.0 | 5.0 | 7.5 |
| Ø d | 0.5 | 0.5 | 0.5 | 0.6 | 0.6 | 0.8 |

| | |
|---|--------------|
| α | (L < 16) 1.0 |
| | (L ≥ 16) 2.0 |

Standard Ratings

DxL(mm); R.C. (mA rms) at 105°C 100KHz; IMP (Ω max) at 20°C, -10°C 100KHz.

| Cap (µF) | V | Item | 6.3 | | | 10 | | | 16 | | | | |
|----------|---|--------|-------|-------|-------|--------|-------|-------|-------|--------|-------|-------|------|
| | | | D x L | IMP | | R.C. | D x L | IMP | | D x L | IMP | | R.C. |
| | | | | 20°C | -10°C | | | 20°C | -10°C | | 20°C | -10°C | |
| 100 | | | | | | | | | 5x11 | 0.230 | 0.760 | 360 | |
| 150 | | | | | | 5x11 | 0.230 | 0.760 | 360 | 6.3x11 | 0.100 | 0.330 | 450 |
| 220 | | 5x11 | 0.230 | 0.760 | 360 | 6.3x11 | 0.100 | 0.330 | 450 | 6.3x11 | 0.100 | 0.330 | 550 |
| 330 | | 6.3x11 | 0.100 | 0.330 | 460 | 6.3x11 | 0.100 | 0.330 | 550 | 8x12 | 0.059 | 0.181 | 830 |
| 470 | | 6.3x11 | 0.100 | 0.330 | 550 | 8x12 | 0.059 | 0.181 | 820 | 8x12 | 0.059 | 0.181 | 990 |
| 680 | | 8x12 | 0.059 | 0.181 | 900 | 8x12 | 0.059 | 0.181 | 990 | 8x16 | 0.046 | 0.143 | 1330 |
| 820 | | 8x12 | 0.059 | 0.181 | 990 | 10x13 | 0.043 | 0.133 | 1250 | 10x16 | 0.030 | 0.095 | 1650 |
| 1000 | | 10x13 | 0.043 | 0.133 | 1250 | 8x16 | 0.046 | 0.143 | 1330 | 8x20 | 0.031 | 0.105 | 1550 |
| | | | | | | 10x13 | 0.043 | 0.133 | 1360 | 10x16 | 0.030 | 0.095 | 1815 |
| 1200 | | 8x16 | 0.046 | 0.143 | 1300 | 10x16 | 0.030 | 0.095 | 1650 | 10x20 | 0.019 | 0.057 | 1930 |
| | | 10x13 | 0.043 | 0.133 | 1360 | | | | | | | | |
| 1500 | | 8x20 | 0.031 | 0.105 | 1550 | 8x20 | 0.031 | 0.105 | 1550 | 10x20 | 0.019 | 0.057 | 2160 |
| | | | | | | 10x16 | 0.030 | 0.095 | 1815 | | | | |
| 1800 | | 10x16 | 0.030 | 0.095 | 1815 | 10x20 | 0.019 | 0.057 | 2160 | 10x25 | 0.017 | 0.051 | 2475 |
| 2200 | | 10x20 | 0.019 | 0.057 | 2160 | 10x25 | 0.017 | 0.051 | 2450 | 13x21 | 0.016 | 0.041 | 2725 |
| 2700 | | 10x25 | 0.017 | 0.051 | 2475 | 13x21 | 0.016 | 0.041 | 2475 | 13x25 | 0.015 | 0.038 | 3190 |
| 3300 | | 13x21 | 0.016 | 0.041 | 2500 | 13x21 | 0.016 | 0.041 | 2725 | 13x30 | 0.013 | 0.033 | 3795 |
| | | | | | | | | | | 16x22 | 0.015 | 0.038 | 3575 |
| 3900 | | 13x21 | 0.016 | 0.041 | 2725 | 13x25 | 0.014 | 0.036 | 3190 | 13x35 | 0.011 | 0.029 | 3925 |
| 4700 | | 13x25 | 0.014 | 0.036 | 3190 | 13x30 | 0.012 | 0.031 | 3795 | 16x26 | 0.012 | 0.033 | 3990 |
| | | | | | | 16x22 | 0.014 | 0.036 | 3575 | | | | |
| 5600 | | 13x30 | 0.012 | 0.031 | 3795 | 13x35 | 0.011 | 0.029 | 3925 | | | | |
| 6800 | | 13x35 | 0.011 | 0.029 | 3925 | 16x26 | 0.012 | 0.033 | 3990 | | | | |
| | | 16x22 | 0.014 | 0.036 | 3575 | | | | | | | | |
| 8200 | | 16x26 | 0.012 | 0.033 | 3990 | | | | | | | | |

※13mm may be replaced by 12.5mm upon customer's request.

RLF Series

Standard Ratings

DxL(mm); R.C. (mA rms) at 105°C 100KHz; IMP (Ω max)at 20°C,-10°C 100KHz.

| Cap (μ F) | V | 25 | | | | 35 | | | |
|----------------|-------|--------|-------|-------|------|--------|-------|-------|------|
| | Item | D x L | IMP | | R.C. | D x L | IMP | | R.C. |
| | | | 20°C | -10°C | | | 20°C | -10°C | |
| 47 | | | | | | 5x11 | 0.230 | 0.760 | 360 |
| 68 | | 5x11 | 0.230 | 0.760 | 360 | 6.3x11 | 0.100 | 0.330 | 450 |
| 100 | | 6.3x11 | 0.100 | 0.330 | 450 | 6.3x11 | 0.100 | 0.330 | 550 |
| 150 | | 8x12 | 0.085 | 0.260 | 620 | 8x12 | 0.059 | 0.181 | 820 |
| 220 | | 8x12 | 0.059 | 0.181 | 810 | 8x12 | 0.059 | 0.181 | 990 |
| 270 | | 8x12 | 0.059 | 0.181 | 900 | 8x16 | 0.046 | 0.143 | 1330 |
| 330 | | 8x12 | 0.059 | 0.181 | 990 | 10x13 | 0.043 | 0.133 | 1360 |
| 390 | | 8x16 | 0.046 | 0.143 | 1330 | 8x20 | 0.031 | 0.105 | 1550 |
| 470 | | 10x13 | 0.043 | 0.133 | 1360 | 10x16 | 0.030 | 0.095 | 1815 |
| 560 | | 8x20 | 0.032 | 0.110 | 1550 | 10x20 | 0.030 | 0.095 | 2160 |
| 680 | | 10x16 | 0.031 | 0.100 | 1815 | 10x25 | 0.027 | 0.080 | 2475 |
| 820 | | 10x20 | 0.020 | 0.062 | 2160 | 13x21 | 0.022 | 0.065 | 2725 |
| 1000 | | 10x25 | 0.018 | 0.055 | 2475 | 13x21 | 0.019 | 0.053 | 2920 |
| 1200 | | 13x21 | 0.017 | 0.049 | 2650 | 13x25 | 0.015 | 0.043 | 3190 |
| 1500 | | 13x21 | 0.023 | 0.059 | 2725 | 13x30 | 0.013 | 0.040 | 3795 |
| | 16x22 | | | | | 0.014 | 0.036 | 3575 | |
| 1800 | | 13x25 | 0.020 | 0.051 | 3190 | 13x35 | 0.011 | 0.029 | 3925 |
| 2200 | | 13x30 | 0.018 | 0.046 | 3795 | 16x26 | 0.012 | 0.033 | 3990 |
| | | 16x22 | 0.014 | 0.036 | 3575 | | | | |
| 2700 | | 13x35 | 0.011 | 0.029 | 3925 | | | | |
| 3300 | | 16x26 | 0.012 | 0.033 | 3990 | | | | |

※13mm may be replaced by 12.5mm upon customer's request.

RLG Series

- High ripple current, Low impedance at high frequency range.
- 105°C 10000 hours long life.
- RoHS Compliant & Halogen Free

Specifications

| Items | Characteristics | | | | | | | | | | |
|--|--|---|----------|------------|------|------------|------|-------------|------|------|--|
| Capacitance Tolerance | ± 20% (120Hz, 20°C) | | | | | | | | | | |
| Operating Temperature Range | -40 ~ +105°C | | | | | | | | | | |
| Rated Voltage Range | 6.3 ~ 100VDC | | | | | | | | | | |
| Leakage Current | $I \leq 0.01CV$ or 3 (μA) which is greater. (After 2 minutes application of DC rated voltage, at 20 °C) | | | | | | | | | | |
| 0.15 Dissipation Factor | Measurement Frequency: 120Hz. Temperature: 20°C | | | | | | | | | | |
| | Rated Voltage (V) | 6.3 | 10 | 16 | 25 | 35 | 50 | 63~80 | 100 | 120 | |
| | tan δ(Max) | 0.22 | 0.19 | 0.16 | 0.14 | 0.12 | 0.10 | 0.09 | 0.08 | 0.15 | |
| When nominal capacitance over 1000μF, tan δ shall be added 0.02 to the listed value with increase of every 1000μF. | | | | | | | | | | | |
| Low Temperature Stability | Measurement Frequency: 120Hz. | | | | | | | | | | |
| | Rated Voltage(V) | 6.3 | 10 | 16 | 25 | 35 | 50 | 63~80 | 100 | | |
| | Z(-25°C)/Z(20°C) | 4 | 3 | 2 | 2 | 2 | 2 | 2 | 2 | | |
| Impedance Ratio (Max) | Z(-40°C)/Z(20°C) | 8 | 6 | 4 | 3 | 3 | 3 | 3 | 3 | | |
| | The following specifications shall be satisfied when the capacitors are restored to 20°C after subjected to DC voltage with the rated ripple current is applied for varied hours according to varied ψ and voltage (Please refer the below sheet)at 105° | | | | | | | | | | |
| Load Life | Case Size | | ψD ≤ 6.3 | | | ψD = 8,10 | | ψD ≥ 13 | | | |
| | Rated Voltage(V) | 6.3~10 V | | 4,000hours | | 6,000hours | | 8,000hours | | | |
| | | 16~100 V | | 5,000hours | | 7,000hours | | 10,000hours | | | |
| | Capacitance Change | Within ± 25% of Initial Value | | | | | | | | | |
| | tan δ | 200% or less of Initial Specified Value | | | | | | | | | |
| Leakage Current | Initial Specified Value or less | | | | | | | | | | |
| Shelf Life | The following specifications shall be satisfied when the capacitors are restored to 20°C after exposing them for 1,000 hours 105°C without voltage applied. Before the measurement the capacitor shall be preconditioned by applying voltage according to them 4.1 of JIS C5101-4. | | | | | | | | | | |
| | Capacitance Change | Within ± 20% of Initial Value | | | | | | | | | |
| | tan δ | 200% or less of Initial Specified Value | | | | | | | | | |
| | Leakage Current | Initial Specified Value or less | | | | | | | | | |
| Standards | JIS C 5101-4 (IEC 60384) | | | | | | | | | | |

Frequency Coefficient of Permissible Ripple Current

| Capacitance (μF) | Frequency (Hz) | | | | |
|------------------|----------------|------|------|------|------|
| | 50 | 120 | 300 | 1K | 100K |
| ≤ 33 | 0.50 | 0.55 | 0.70 | 0.90 | 1.00 |
| 47 ~ 330 | 0.60 | 0.70 | 0.85 | 0.95 | 1.00 |
| 470 ~ 1000 | 0.65 | 0.75 | 0.90 | 0.98 | 1.00 |
| 1200 ~ 18000 | 0.70 | 0.80 | 0.95 | 1.00 | 1.00 |

The endurance of capacitors is reduced with internal heating produced by ripple current at the rate of halving the lifetime with every 5°C rise. When long life performance is required in actual use, the RMS ripple current has to be reduced.

RLG Series

Standard Ratings

DxL(mm) ; R.C.(mA rms) at 105°C 100KHz; IMP (Ω max)at 20°C,-10°C 100KHz.

| Cap (μF) | V | 16 | | | | 25 | | | |
|----------|-------|--------|-------|-------|------|--------|-------|-------|------|
| | Item | D x L | IMP | | R.C. | D x L | IMP | | R.C. |
| | | | 20°C | -10°C | | | 20°C | -10°C | |
| 47 | | | | | | 5x11 | 0.570 | 2.300 | 200 |
| 56 | | 5x11 | 0.570 | 2.300 | 220 | 5x11 | 0.570 | 2.300 | 240 |
| 100 | | 6.3x11 | 0.210 | 0.820 | 310 | 6.3x11 | 0.210 | 0.870 | 340 |
| 120 | | 6.3x11 | 0.210 | 0.870 | 340 | | | | |
| 220 | | 8x12 | 0.190 | 0.850 | 510 | 8x12 | 0.120 | 0.520 | 650 |
| 330 | | 8x12 | 0.120 | 0.520 | 650 | 8x16 | 0.087 | 0.350 | 850 |
| | 10x13 | | | | | 0.081 | 0.320 | 870 | |
| 470 | | 8x16 | 0.086 | 0.350 | 840 | 8x20 | 0.070 | 0.270 | 1050 |
| | | 10x13 | 0.080 | 0.320 | 865 | 10x16 | 0.060 | 0.240 | 1210 |
| 680 | | 8x20 | 0.069 | 0.270 | 1060 | 10x20 | 0.045 | 0.180 | 1410 |
| | | 10x16 | 0.060 | 0.240 | 1210 | 13x16 | 0.049 | 0.160 | 1460 |
| 820 | | 10x20 | 0.052 | 0.220 | 1310 | 10x25 | 0.041 | 0.170 | 1660 |
| 1000 | | 10x20 | 0.045 | 0.180 | 1410 | 10x30 | 0.030 | 0.120 | 1920 |
| | 13x21 | | | | | 0.034 | 0.120 | 1910 | |
| | 16x15 | | | | | 0.042 | 0.120 | 1940 | |
| 1200 | | 10x25 | 0.043 | 0.170 | 1650 | 18x15 | 0.043 | 0.110 | 2220 |
| 1500 | | 10x30 | 0.030 | 0.120 | 1920 | 13x25 | 0.026 | 0.089 | 2240 |
| | | 13x21 | 0.035 | 0.120 | 1910 | | | | |
| | | 16x15 | 0.042 | 0.120 | 1940 | | | | |
| 1800 | | 13x25 | 0.028 | 0.095 | 2140 | 13x30 | 0.024 | 0.078 | 2660 |
| | | | | | | 16x22 | 0.026 | 0.078 | 2540 |
| 2200 | | 13x25 | 0.026 | 0.089 | 2240 | 13x35 | 0.020 | 0.065 | 2890 |
| | | 18x15 | 0.042 | 0.110 | 2220 | 18x20 | 0.025 | 0.066 | 2870 |
| 2700 | | 13x30 | 0.023 | 0.077 | 2650 | 13x40 | 0.016 | 0.056 | 3360 |
| | | 16x22 | 0.026 | 0.078 | 2540 | 16x26 | 0.021 | 0.060 | 2940 |
| 3300 | | 13x35 | 0.020 | 0.066 | 2890 | 16x32 | 0.016 | 0.050 | 3460 |
| | | | | | | 18x25 | 0.018 | 0.048 | 3150 |
| 3900 | | 13x40 | 0.016 | 0.056 | 3350 | 16x36 | 0.014 | 0.043 | 3620 |
| | | 16x26 | 0.021 | 0.060 | 2930 | 18x32 | 0.015 | 0.040 | 4180 |
| | | 16x22 | 0.025 | 0.067 | 2860 | | | | |
| 4700 | | 16x32 | 0.016 | 0.050 | 3450 | 16x40 | 0.014 | 0.044 | 4080 |
| | | 18x25 | 0.018 | 0.049 | 3150 | 18x35 | 0.013 | 0.040 | 4230 |
| 5600 | | 16x36 | 0.015 | 0.044 | 3620 | 18x40 | 0.011 | 0.032 | 4290 |
| | | 18x32 | 0.015 | 0.040 | 4180 | | | | |
| 6800 | | 16x40 | 0.012 | 0.038 | 4080 | | | | |
| 8200 | | 18x35 | 0.014 | 0.038 | 4230 | | | | |
| 10000 | | 18x40 | 0.011 | 0.032 | 4290 | | | | |

※13mm may be replaced by 12.5mm upon customer's request.

RLG Series

Standard Ratings

DxL(mm) ; R.C.(mA rms) at 105°C 100KHz; IMP (Ω max)at 20°C,-10°C 100KHz.

| Cap (μF) | V | 35 | | | 50 | | | | |
|----------|---|--------|-------|-------|--------|-------|-------|-------|------|
| | | D x L | IMP | | D x L | IMP | | R.C. | |
| | | | | | | | | | |
| 22 | | | | | 5x11 | 0.700 | 2.800 | 180 | |
| 33 | | 5x11 | 0.560 | 2.300 | | | | | |
| 47 | | 6.3x11 | 0.350 | 1.400 | 6.3x11 | 0.380 | 1.500 | 220 | |
| 56 | | 6.3x11 | 0.210 | 0.860 | 6.3x11 | 0.300 | 1.200 | 300 | |
| 100 | | 8x12 | 0.150 | 0.560 | 8x12 | 0.160 | 0.670 | 560 | |
| 120 | | | | | 8x16 | 0.120 | 0.480 | 740 | |
| 150 | | 8x12 | 0.130 | 0.520 | 10x13 | 0.120 | 0.480 | 770 | |
| 180 | | 8x16 | 0.086 | 0.350 | 8x20 | 0.090 | 0.360 | 920 | |
| 220 | | 8x16 | 0.086 | 0.350 | 10x16 | 0.083 | 0.340 | 1050 | |
| | | 10x13 | 0.080 | 0.320 | | | | | 865 |
| 270 | | 8x20 | 0.070 | 0.260 | 1060 | 10x20 | 0.060 | 0.240 | 1230 |
| | | | | | | 13x16 | 0.062 | 0.200 | 1250 |
| 330 | | 10x16 | 0.060 | 0.240 | 1210 | 10x25 | 0.053 | 0.220 | 1450 |
| 470 | | 10x20 | 0.045 | 0.180 | 1410 | 10x30 | 0.043 | 0.170 | 1695 |
| | | 13x16 | 0.048 | 0.150 | 1460 | 13x21 | 0.044 | 0.150 | 1670 |
| | | | | | | 16x15 | 0.054 | 0.170 | 1695 |
| | | | | | | 13x25 | 0.033 | 0.110 | 1950 |
| 560 | | 10x25 | 0.041 | 0.160 | 1650 | 18x15 | 0.053 | 0.150 | 1940 |
| 680 | | 10x30 | 0.030 | 0.120 | 1920 | 13x30 | 0.030 | 0.100 | 2320 |
| | | 13x21 | 0.033 | 0.132 | 1910 | | | | |
| | | 16x15 | 0.041 | 0.143 | 1950 | | | | |
| 820 | | 13x25 | 0.028 | 0.088 | 2100 | 13x35 | 0.023 | 0.081 | 2520 |
| | | | | | | 16x22 | 0.033 | 0.100 | 2220 |
| 1000 | | 13x25 | 0.028 | 0.088 | 2230 | 13x40 | 0.020 | 0.069 | 2930 |
| | | | | | | 16x26 | 0.025 | 0.075 | 2555 |
| | | | | | | 18x20 | 0.036 | 0.097 | 2490 |
| | | | | | | 16x32 | 0.021 | 0.066 | 3020 |
| 1200 | | 16x22 | 0.026 | 0.078 | 2530 | 18x25 | 0.025 | 0.070 | 2750 |
| 1500 | | 13x35 | 0.020 | 0.065 | 2880 | 16x36 | 0.018 | 0.056 | 3150 |
| 1800 | | 13x40 | 0.016 | 0.056 | 3350 | 16x40 | 0.016 | 0.048 | 3720 |
| | | 16x26 | 0.020 | 0.060 | 2940 | | | | |
| | | 18x20 | 0.025 | 0.066 | 2870 | 18x32 | 0.021 | 0.057 | 3640 |
| 2200 | | 16x32 | 0.016 | 0.050 | 3500 | 18x35 | 0.017 | 0.046 | 3690 |
| | | 18x25 | 0.019 | 0.049 | 3140 | | | | |
| 2700 | | 16x36 | 0.015 | 0.044 | 3620 | 18x40 | 0.014 | 0.038 | 3810 |
| | | 18x32 | 0.014 | 0.040 | 4180 | | | | |
| 3300 | | 16x40 | 0.013 | 0.038 | 4090 | | | | |
| | | 18x35 | 0.014 | 0.040 | 4230 | | | | |

※13mm may be replaced by 12.5mm upon customer's request.

RLG Series

Standard Ratings

DxL(mm) ; R.C.(mA rms) at 105°C 100KHz ; IMP (Ω max)at 20°C,-10°C 100KHz.

| Cap (μF) | V | 63 | | | | 100 | | | |
|----------|------|--------|-------|-------|------|--------|-------|-------|------|
| | Item | D x L | IMP | | R.C. | D x L | IMP | | R.C. |
| | | | 20°C | -10°C | | | 20°C | -10°C | |
| 6.8 | | | | | | 5x11 | 2.200 | 9.200 | 56 |
| 15 | | 5x11 | 2.200 | 9.200 | 56 | 6.3x11 | 1.200 | 5.000 | 120 |
| 27 | | | | | | 8x12 | 0.720 | 3.000 | 235 |
| 33 | | 6.3x11 | 1.200 | 5.000 | 120 | | | | |
| 39 | | | | | | 8x16 | 0.62 | 2.540 | 280 |
| 47 | | 8x12 | 0.680 | 3.100 | 190 | 10x13 | 0.430 | 1.800 | 290 |
| 56 | | 8x12 | 0.620 | 2.800 | 235 | 8x20 | 0.320 | 1.600 | 340 |
| 68 | | | | | | 10x16 | 0.300 | 1.500 | 358 |
| 82 | | 8x16 | 0.450 | 2.100 | 310 | 10x20 | 0.210 | 0.940 | 470 |
| | | 10x13 | 0.430 | 1.800 | 300 | 13x16 | 0.230 | 1.100 | 468 |
| 100 | | 10x16 | 0.350 | 1.800 | 320 | 10x25 | 0.200 | 0.840 | 536 |
| 120 | | 8x20 | 0.330 | 1.600 | 362 | 10x30 | 0.150 | 0.710 | 666 |
| | | 10x16 | 0.300 | 1.500 | 357 | 13x21 | 0.160 | 0.640 | 690 |
| 150 | | | | | | 16x15 | 0.140 | 0.660 | 795 |
| 180 | | 10x20 | 0.200 | 0.940 | 470 | 13x25 | 0.120 | 0.450 | 790 |
| | | 13x16 | 0.230 | 1.100 | 465 | 18x15 | 0.120 | 0.500 | 930 |
| 220 | | 10x25 | 0.200 | 0.840 | 531 | 13x30 | 0.110 | 0.450 | 905 |
| | | | | | | 16x22 | 0.090 | 0.370 | 1050 |
| 270 | | 10x30 | 0.150 | 0.700 | 663 | 13x35 | 0.082 | 0.350 | 1060 |
| | | 13x21 | 0.160 | 0.640 | 690 | | | | |
| | | 16x15 | 0.130 | 0.650 | 795 | 16x26 | 0.072 | 0.270 | 1250 |
| 330 | | 13x25 | 0.120 | 0.450 | 790 | 13x40 | 0.070 | 0.300 | 1190 |
| | | | | | | 18x20 | 0.080 | 0.300 | 1250 |
| 390 | | 18x15 | 0.120 | 0.500 | 920 | 16x32 | 0.053 | 0.200 | 1570 |
| | | | | | | 18x25 | 0.056 | 0.210 | 1490 |
| 470 | | 13x30 | 0.100 | 0.420 | 910 | 16x36 | 0.045 | 0.170 | 1790 |
| | | 16x22 | 0.090 | 0.380 | 1040 | 18x32 | 0.047 | 0.170 | 1640 |
| 560 | | 13x35 | 0.082 | 0.350 | 1050 | 16x40 | 0.040 | 0.150 | 2030 |
| | | 16x26 | 0.073 | 0.270 | 1250 | | | | |
| 680 | | 13x40 | 0.070 | 0.300 | 1190 | 18x35 | 0.040 | 0.150 | 1790 |
| | | 18x20 | 0.080 | 0.300 | 1240 | | | | |
| 820 | | 16x32 | 0.053 | 0.200 | 1580 | 18x40 | 0.036 | 0.130 | 2340 |
| | | 18x25 | 0.057 | 0.210 | 1490 | | | | |
| 1000 | | 16x36 | 0.045 | 0.170 | 1790 | | | | |
| | | 18x32 | 0.047 | 0.170 | 1640 | | | | |
| 1200 | | 16x40 | 0.039 | 0.150 | 2020 | | | | |
| | | 18x35 | 0.040 | 0.150 | 1790 | | | | |
| 1500 | | 18x40 | 0.035 | 0.130 | 2340 | | | | |

※13mm may be replaced by 12.5mm upon customer's request.

RLJ Series

- 105°C High ripple and Low impedance, long life: 6,000~10,000 hours.
- Suited for LCD TV BLU Inverter, SMPS, IP-Board, Adaptor etc.
- RoHS Compliant & Halogen Free

Specifications

| Items | Characteristics | | | | | | | | | | |
|--|--|------|---|---|------|-------------|-----|-------------------------------|------|------------|------|
| Capacitance Tolerance | ± 20% (120Hz, 20°C) | | | | | | | | | | |
| Operating Temperature Range | -40 ~ +105°C | | | | | | | | | | |
| Rated Voltage Range | 6.3 ~ 100VDC | | | | | | | | | | |
| Leakage Current | $I \leq 0.01CV$ or 3 (μA) which is greater. (After 2 minutes application of DC rated voltage, at 20 °C) | | | | | | | | | | |
| Dissipation Factor | Measurement Frequency: 120Hz. Temperature: 20°C | | | | | | | | | | |
| | Rated Voltage (V) | 6.3 | 10 | 16 | 25 | 35 | 50 | 63 | 80 | 100 | 120 |
| | tan δ(Max) | 0.22 | 0.19 | 0.16 | 0.14 | 0.12 | 0.1 | 0.09 | 0.08 | 0.08 | 0.15 |
| When nominal capacitance over 1000μF, tan δ shall be added 0.02 to the listed value with increase of every 1000μF. | | | | | | | | | | | |
| Low Temperature Stability | Measurement Frequency: 120Hz. | | | | | | | | | | |
| | Rated Voltage(V) | 6.3 | 10 | 16 | 25 | 35 | 50 | 63 | 80 | 100 | |
| | Z(-25°C)/Z(20°C) | 2 | 2 | 2 | 2 | 2 | 2 | 2 | 2 | 2 | |
| Impedance Ratio (Max) | Z(-40°C)/Z(20°C) | 3 | 3 | 3 | 3 | 3 | 3 | 3 | 3 | 3 | |
| | The following specifications shall be satisfied when the capacitors are restored to 20°C after subjected to DC voltage with the rated ripple current is applied for varied hours according to varied ψ and voltage (Please refer the below sheet)at 105° | | | | | | | | | | |
| Load Life | Case Size (ψD) | | | | | Life Time | | | | | |
| | | | | | | 6.3V | | 10 ~ 50V | | 63 ~ 100V | |
| | ψ5 ~ ψ6.3 | | | | | 6,000hours | | 7,000hours | | 6,000hours | |
| | ψ8 x12~8 x 14 | | | | | 8,000hours | | 9,000hours | | 8,000hours | |
| | ψ8x15L ~ 25L | | | | | 9,000hours | | 10,000hours | | 9,000hours | |
| | ψ10x13L | | | | | 9,000hours | | | | | |
| | ψ10x16L ~ 25L | | | | | 10,000hours | | | | | |
| | > ψ10 | | | | | 10,000hours | | | | | |
| | Rated Voltage(V) | | | 6.3~10 V | | | | 16~100 V | | | |
| | Capacitance Change | | | Within ± 30% of Initial Value | | | | Within ± 25% of Initial Value | | | |
| tan δ | | | 200% or less of Initial Specified Value | | | | | | | | |
| Leakage Current | | | Initial Specified Value or less | | | | | | | | |
| Shelf Life | The following specifications shall be satisfied when the capacitors are restored to 20°C after exposing them for 1,000 hours 105°C without voltage applied. Before the measurement the capacitor shall be preconditioned by applying voltage according to them 4.1 of JIS C5101-4. | | | | | | | | | | |
| | Capacitance Change | | | Within ± 20% of Initial Value | | | | | | | |
| | tan δ | | | 200% or less of Initial Specified Value | | | | | | | |
| | Leakage Current | | | Initial Specified Value or less | | | | | | | |
| Standards | JIS C 5101-4-1 (IEC 60384) | | | | | | | | | | |

Frequency Coefficient of Permissible Ripple Current

| Capacitance (μF) | Frequency (Hz) | | | |
|------------------|----------------|------|------|------|
| | 120 | 1K | 10K | 100K |
| 5.6 ~ 180 | 0.40 | 0.70 | 0.90 | 1.00 |
| 220 ~ 560 | 0.50 | 0.85 | 0.94 | 1.00 |
| 680 ~ 1800 | 0.60 | 0.87 | 0.95 | 1.00 |
| 2200 ~ 3900 | 0.75 | 0.90 | 0.95 | 1.00 |
| 4700 ~ 18000 | 0.85 | 0.95 | 0.98 | 1.00 |

The endurance of capacitors is reduced with internal heating produced by ripple current at the rate of halving the lifetime with every 5°C rise. When long life performance is required in actual use, the RMS ripple current has to be reduced.

RLJ Series

Dimensions (mm)

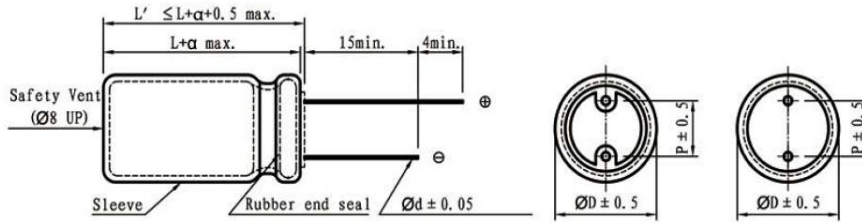

| | | | | | | | |
|-----|-----|-----|-----|-----|-----|-----|-----|
| Ø D | 5 | 6.3 | 8 | 10 | 13 | 16 | 18 |
| P | 2.0 | 2.5 | 3.5 | 5 | 5 | 7.5 | 7.5 |
| Ø d | 0.5 | 0.5 | 0.5 | 0.6 | 0.6 | 0.8 | 0.8 |

| | |
|---|--------------|
| α | (L < 16) 1.0 |
| | (L ≥ 16) 2.0 |

Standard Ratings

DxL(mm); R.C. (mA rms) at 105°C 100KHz ; IMP (Ω max) at 20°C 100KHz.

| Cap (µF) | V | 6.3 | | | 10 | | | 16 | | | 25 | | |
|----------|---|--------|-------|-------|--------|-------|-------|--------|-------|-------|--------|-------|-------|
| | | Item | D x L | R.C. | IMP | D x L | R.C. | IMP | D x L | R.C. | IMP | D x L | R.C. |
| 68 | | | | | | | | | | | 5x12 | 460 | 0.390 |
| 120 | | | | | | | | 5x12 | 460 | 0.390 | | | |
| 150 | | | | | 5x12 | 460 | 0.390 | | | | 6.3x12 | 690 | 0.160 |
| 220 | | 5x12 | 350 | 0.390 | | | | | | | | | |
| 270 | | | | | | | | 6.3x12 | 690 | 0.160 | | | |
| 330 | | | | | 6.3x12 | 690 | 0.160 | | | | 8x12 | 1210 | 0.074 |
| 390 | | | | | | | | | | | 8x16 | 1610 | 0.058 |
| 470 | | 6.3x12 | 530 | 0.180 | | | | 8x12 | 1210 | 0.074 | 10x13 | 1690 | 0.052 |
| 560 | | | | | 8x12 | 1210 | 0.074 | 8x16 | 1610 | 0.058 | 8x20 | 1970 | 0.040 |
| 680 | | | | | 8x16 | 1610 | 0.058 | 10x13 | 1690 | 0.052 | 10x16 | 1990 | 0.037 |
| 820 | | 8x12 | 940 | 0.074 | 10x13 | 1690 | 0.052 | 8x20 | 1970 | 0.040 | | | |
| 1000 | | 8x16 | 1245 | 0.060 | 8x20 | 1970 | 0.040 | 10x16 | 1990 | 0.037 | 10x20 | 2520 | 0.027 |
| 1200 | | 10x13 | 1510 | 0.052 | 10x16 | 1990 | 0.037 | | | | 10x25 | 2910 | 0.023 |
| 1500 | | 8x20 | 1510 | 0.042 | | | | 10x20 | 2520 | 0.027 | 13x21 | 2610 | 0.024 |
| 1800 | | 10x16 | 1765 | 0.037 | 10x20 | 2520 | 0.027 | 10x25 | 2910 | 0.023 | 13x25 | 3060 | 0.018 |
| 2200 | | | | | 10x25 | 2910 | 0.023 | 13x21 | 2610 | 0.024 | 13x30 | 3490 | 0.017 |
| 2700 | | | | | | | | | | | 16x22 | 3250 | 0.021 |
| 2700 | | 10x20 | 1965 | 0.027 | 13x21 | 2610 | 0.024 | 13x25 | 3060 | 0.018 | 13x35 | 3650 | 0.016 |
| 3300 | | 10x25 | 2260 | 0.023 | 13x25 | 3060 | 0.018 | 13x30 | 3490 | 0.017 | 16x25 | 3650 | 0.017 |
| 3900 | | | | | | | | 16x22 | 3250 | 0.021 | | | |
| 3900 | | 13x21 | 2485 | 0.024 | | | | 13x35 | 3650 | 0.016 | | | |
| 4700 | | 13x25 | 2910 | 0.019 | 13x30 | 3490 | 0.017 | | | | | | |
| 5600 | | | | | 16x22 | 3250 | 0.021 | 16x25 | 3650 | 0.017 | | | |
| 5600 | | 13x30 | 3455 | 0.017 | 13x35 | 3620 | 0.016 | | | | | | |
| 6800 | | | | | 16x25 | 3650 | 0.017 | | | | | | |
| 6800 | | 13x35 | 3565 | 0.015 | | | | | | | | | |
| 8200 | | 16x22 | 3245 | 0.021 | | | | | | | | | |
| 8200 | | 16x26 | 3640 | 0.017 | | | | | | | | | |

※ 13mm may be replaced by 12.5mm upon customer's request.

RLJ Series

Standard Ratings

DxL(mm) ; R.C.(mA rms) at 105°C 100KHz; IMP (Ω max)at 20°C 100KHz.

| Cap (μF) | V | 35 | | | 50 | | | 63 | | |
|----------|------|--------|------|-------|--------|------|-------|--------|------|-------|
| | Item | D x L | R.C. | IMP | D x L | R.C. | IMP | D x L | R.C. | IMP |
| 18 | | | | | | | | 5x12 | 250 | 0.700 |
| 27 | | | | | 5x12 | 300 | 0.48 | | | |
| 33 | | | | | | | | | | |
| 47 | | 5x12 | 460 | 0.39 | | | | 6.3x12 | 430 | 0.500 |
| 56 | | | | | 6.3x12 | 490 | 0.23 | 8x12 | 500 | 0.350 |
| 68 | | | | | | | | | | |
| 82 | | | | | | | | 8x12 | 720 | 0.350 |
| 100 | | 6.3x12 | 690 | 0.16 | 8x12 | 940 | 0.13 | 8x16 | 990 | 0.300 |
| 120 | | | | | 8x16 | 1240 | 0.081 | 10x13 | 990 | 0.280 |
| 150 | | | | | 8x20 | 1600 | 0.057 | 8x20 | 1200 | 0.200 |
| | | | | | 10x13 | 1270 | 0.072 | | | |
| 180 | | 8x12 | 1210 | 0.074 | | | | 10x16 | 1200 | 0.100 |
| 220 | | 8x16 | 1610 | 0.058 | 10x16 | 1645 | 0.052 | | | |
| 270 | | 10x13 | 1690 | 0.052 | | | | 10x20 | 1580 | 0.080 |
| 330 | | 8x20 | 1970 | 0.04 | 10x20 | 2065 | 0.037 | 10x25 | 1990 | 0.075 |
| 390 | | 10x16 | 1990 | 0.037 | 10x25 | 2250 | 0.031 | 13x21 | 1990 | 0.065 |
| 470 | | | | | 13x21 | 2210 | 0.032 | 13x25 | 2450 | 0.055 |
| 560 | | 10x20 | 2520 | 0.027 | | | | 13x30 | 2750 | 0.05 |
| | | | | | | | | 16x22 | 2150 | 0.052 |
| 680 | | 10x25 | 2910 | 0.023 | 13x25 | 2510 | 0.026 | 13x35 | 3050 | 0.045 |
| 820 | | 13x21 | 2610 | 0.024 | 13x30 | 3100 | 0.023 | 16x26 | 2560 | 0.048 |
| | | | | | 16x22 | 2750 | 0.026 | | | |
| 1000 | | | | | 13x35 | 3250 | 0.021 | | | |
| | | | | | 16x25 | 3000 | 0.022 | | | |
| 1200 | | 13x25 | 3060 | 0.017 | | | | | | |
| 1500 | | 13x30 | 3490 | 0.017 | | | | | | |
| | | 16x22 | 3250 | 0.021 | | | | | | |
| 1800 | | 13x35 | 3620 | 0.016 | | | | | | |
| | | 16x25 | 3650 | 0.017 | | | | | | |

※ 13mm may be replaced by 12.5mm upon customer's request.

RLJ Series

Standard Ratings

DxL(mm) ; R.C.(mA rms) at 105°C 100KHz; IMP (Ω max)at 20°C 100KHz.

| Cap (μF) | V | 80 | | | 100 | | |
|----------|------|--------|------|-------|--------|------|-------|
| | Item | D x L | R.C. | IMP | D x L | R.C. | IMP |
| 8.2 | | | | | 5x12 | 230 | 1.200 |
| 12 | | 5x12 | 230 | 0.800 | | | |
| 18 | | | | | 6.3x12 | 360 | 0.580 |
| 27 | | 6.3x12 | 380 | 0.550 | 8x12 | 450 | 0.430 |
| 33 | | | | | 8x12 | 630 | 0.430 |
| 47 | | 8x12 | 630 | 0.400 | 8x16 | 780 | 0.400 |
| 56 | | 8x16 | 780 | 0.380 | 10x13 | 780 | 0.330 |
| 68 | | 10x13 | 780 | 0.300 | 8x20 | 1050 | 0.250 |
| | | | | | 10x16 | 1050 | 0.130 |
| 82 | | 8x20 | 1050 | 0.230 | | | |
| 100 | | 10x16 | 1050 | 0.110 | 10x20 | 1400 | 0.091 |
| | | | | | 13x16 | 1400 | 0.130 |
| 120 | | | | | 10x25 | 1650 | 0.085 |
| 150 | | 10x20 | 1400 | 0.089 | 13x21 | 1750 | 0.065 |
| | | 13x16 | 1400 | 0.110 | | | |
| 180 | | 10x25 | 1650 | 0.080 | | | |
| 220 | | 13x21 | 1750 | 0.063 | 13x25 | 2200 | 0.063 |
| 270 | | 13x25 | 2200 | 0.060 | 13x30 | 2400 | 0.055 |
| | | | | | 16x22 | 1950 | 0.058 |
| 330 | | 13x30 | 2400 | 0.053 | 13x35 | 2600 | 0.050 |
| | | 16x22 | 1950 | 0.055 | | | |
| 390 | | 13x35 | 2600 | 0.048 | 13x40 | 2860 | 0.045 |
| | | | | | 16x25 | 2450 | 0.043 |
| 470 | | 13x40 | 2860 | 0.038 | 16x32 | 2650 | 0.038 |
| | | 16x25 | 2450 | 0.040 | 18x22 | 2270 | 0.048 |
| 560 | | 16x32 | 2650 | 0.035 | 18x25 | 2500 | 0.042 |
| | | | | | 16x36 | 2860 | 0.036 |
| 680 | | 16x36 | 2860 | 0.033 | 18x32 | 2860 | 0.036 |
| | | 18x25 | 2500 | 0.039 | 16x40 | 3500 | 0.033 |
| 820 | | 16x40 | 3500 | 0.030 | 18x36 | 3500 | 0.033 |
| | | 18x32 | 2860 | 0.033 | 18x40 | 3860 | 0.030 |
| 1000 | | 18x35 | 3500 | 0.030 | | | |

※ 13mm may be replaced by 12.5mm upon customer's request.

RLO Series

- On the basis of RLA Series ripple promotion product
- Suitable for LCD TV Power, SMPS
- RoHS Compliance

Specifications

| Items | Characteristics | | | |
|--|--|---|---------------|------|
| Capacitance Tolerance | ± 20% (120Hz, 20°C) | | | |
| Operating Temperature Range | -40 ~ +105°C | | | |
| Rated Voltage Range | 400VDC | | 450VDC~500VDC | |
| Leakage Current | $I \leq 0.03CV + 20(\mu A)$ (After 5 minutes application of DC rated voltage, at 20 °C) | | | |
| Dissipation Factor | Measurement Frequency: 120Hz. Temperature: 20°C | | | |
| | Rated Voltage (V) | 400V | 450V | 500V |
| | tan δ(Max) | 0.15 | 0.18 | 0.20 |
| When nominal capacitance over 1000μF, tan δ shall be added 0.02 to the listed value with increase of every 1000μF. | | | | |
| Low Temperature Stability | Measurement Frequency: 120Hz. | | | |
| | Rated Voltage(V) | 400 | 450 | 500 |
| | Z(-25°C)/Z(20°C) | 5 | 6 | 6 |
| Impedance Ratio (Max) | Z(-40°C)/Z(20°C) | 10 | 12 | 12 |
| | The following specifications shall be satisfied when the capacitors are restored to 20°C after subjected to DC voltage with the rated ripple current is applied for 3,000 hours at 105° | | | |
| Load Life | Capacitance Change | Within ± 20% of Initial Value | | |
| | tan δ | 200% or less of Initial Specified Value | | |
| | Leakage Current | Initial Specified Value or less | | |
| Shelf Life | The following specifications shall be satisfied when the capacitors are restored to 20°C after exposing them for 1,000 hours 105°C without voltage applied. Before the measurement the capacitor shall be preconditioned by applying voltage according to them 4.1 of JIS C5101-4. | | | |
| | Capacitance Change | Within ± 20% of Initial Value | | |
| | tan δ | 200% or less of Initial Specified Value | | |
| | Leakage Current | Initial Specified Value or less | | |
| Standards | JIS C 5101-4-1 (IEC 60384) | | | |

Frequency Coefficient of Permissible Ripple Current

| Frequency (Hz) | 50 | 120 | 1K | 10K | 100K |
|----------------|------|------|------|------|------|
| Coefficient | 0.55 | 0.65 | 0.80 | 0.90 | 1.00 |

The endurance of capacitors is reduced with internal heating produced by ripple current at the rate of halving the lifetime with every 5°C rise. When long life performance is required in actual use, the RMS ripple current has to be reduced.

RLO Series

Dimensions (mm)

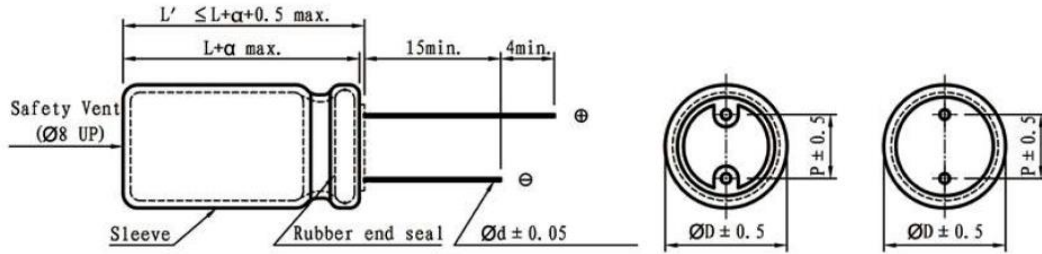

| | | | | | | |
|-----------------|-----|-----|-----|-----|-----|-----|
| $\varnothing D$ | 6.3 | 8 | 10 | 13 | 16 | 18 |
| P | 2.5 | 3.5 | 5.0 | 5.0 | 7.5 | 7.5 |
| $\varnothing d$ | 0.5 | 0.5 | 0.6 | 0.6 | 0.8 | 0.8 |

| | |
|----------|-------------------|
| α | (L < 16) 1.0 |
| | (L \geq 16) 2.0 |

Standard Ratings

D x L (mm), R.C. (mA rms) 125°C 100KHz. IMP: (Ω max) at 20°C, 100KHz

| Cap (μF) | V Item | 400 | | | 450 | | | 500 | | |
|--------------------|-----------|--------|-----|------|---------|------|------|--------|------|------|
| | | D x l | IMP | R.C. | D x l | IMP | R.C. | D x l | IMP | R.C. |
| 4.7 | | 6.3x12 | 9.5 | 120 | 6.3x16 | 15.6 | 115 | 6.3x16 | 17.4 | 82 |
| | | | | | 8x10 | 15.6 | 115 | 8x10 | 15.2 | 82 |
| 6.8 | | 6.3x13 | 8.3 | 130 | 10x10 | 12.7 | 130 | 10x10 | 15.2 | 90 |
| 8.2 | | 6.3x15 | 7.5 | 175 | 8x12 | 9.2 | 165 | 10x11 | 11.1 | 115 |
| 10 | | | | | 8x15 | 8.1 | 195 | 10x13 | 9.8 | 150 |
| | | 8x10 | 5.3 | 195 | 10x11 | 8.1 | 195 | | | |
| 12 | | 8x13 | 4.1 | 235 | 10x13 | 6.3 | 230 | 10x14 | 7.5 | 210 |
| 15 | | 8x15 | 3.9 | 265 | 10x13.5 | 6.0 | 255 | 10x15 | 7.2 | 225 |
| 18 | | 8x17 | 3.1 | 300 | 10x15 | 5.7 | 300 | 10x17 | 6.5 | 245 |
| 22 | | 10x14 | 3.0 | 315 | 10x17 | 5.4 | 315 | 13x17 | 5.6 | 315 |
| | | 8x18 | 3.0 | 315 | | | | | | |
| 27 | | 10x15 | 3.0 | 375 | 10x20 | 4.5 | 375 | 10x23 | 5.3 | 350 |
| 33 | | 10x18 | 2.5 | 445 | 10x35 | 3.1 | 445 | 13x21 | 4.1 | 405 |
| 47 | | 13x19 | 1.9 | 620 | 10x45 | 2.6 | 620 | 16x20 | 3.1 | 565 |
| 68 | | 16x20 | 1.4 | 1010 | 10x50 | 1.6 | 1010 | 18x20 | 2.2 | 815 |
| 82 | | 18x20 | 1.0 | 1200 | 16x25 | 1.3 | 1200 | 18x25 | 1.9 | 980 |
| 100 | | 18x25 | 0.9 | 1350 | 18x25 | 1.0 | 1250 | | | |

RLN Series

- 125°C 5000hours long life product. (4000 hours: 63V to 100V)
- Best - suited to smoothing circuits and control for industrial equipments
Power supplies of which long life and high reliability are required.
- NC terminal added items are lineup for vibration resistance.
(30G guaranteed: 20mm L or less)
- RoHS Compliance.

Specifications

| Items | Characteristics | | | | | | | | |
|--|--|---|------|------|------|------|------|------|------|
| Capacitance Tolerance | ± 20% (120Hz, 20°C) | | | | | | | | |
| Operating Temperature Range | -40 ~ +125°C | | | | | | | | |
| Rated Voltage Range | 10 ~ 100VDC | | | | | | | | |
| Leakage Current | $I \leq 0.01CV$ or 3(μA) (After 2 minutes application of DC rated voltage, at 20 °C) | | | | | | | | |
| Dissipation Factor | Measurement Frequency: 120Hz. Temperature: 20°C | | | | | | | | |
| | Rated Voltage (V) | 10 | 16 | 25 | 35 | 50 | 63 | 80 | 100 |
| | tan δ(Max) | 0.20 | 0.16 | 0.14 | 0.12 | 0.10 | 0.10 | 0.08 | 0.08 |
| When nominal capacitance over 1000μF, tan δ shall be added 0.02 to the listed value with increase of every 1000μF. | | | | | | | | | |
| Low Temperature Stability | Measurement Frequency: 120Hz. | | | | | | | | |
| | Rated Voltage(V) | 10 | 16 | 25 | 35 | 50 | 63 | 80 | 100 |
| | Impedance Ratio (Max) Z(-40°C)/Z(20°C) | 4 | 3 | 3 | 3 | 3 | 3 | 3 | 3 |
| Load Life | 5000 hours, (63~100V, 4000hours) at 125°C | | | | | | | | |
| | Capacitance Change | Within ±30% of Initial Value | | | | | | | |
| | tan δ | 300% or less of Initial Specified Value | | | | | | | |
| | Leakage Current | Initial Specified Value or less | | | | | | | |
| Shelf Life | The following specifications shall be satisfied when the capacitors are restored to 20°C after exposing them for 1,000 hours 105°C without voltage applied. Before the measurement the capacitor shall be preconditioned by applying voltage according to them 4.1 of JIS C5101-4. | | | | | | | | |
| | Capacitance Change | Within ± 30% of Initial Value | | | | | | | |
| | tan δ | 300% or less of Initial Specified Value | | | | | | | |
| | Leakage Current | Initial Specified Value or less | | | | | | | |
| Standards | JIS C 5101-4-1 (IEC 60384) | | | | | | | | |

Frequency Coefficient of Permissible Ripple Current

| Capacitance (μF) | Frequency (Hz) | | | |
|------------------|----------------|------|------|----------|
| | 50~60 | 120 | 1K | 10K~100K |
| 220~330 | 0.55 | 0.65 | 0.85 | 1.00 |
| 390~1000 | 0.70 | 0.75 | 0.90 | 1.00 |
| 1200~8200 | 0.80 | 0.85 | 0.95 | 1.00 |

The endurance of capacitors is reduced with internal heating produced by ripple current at the rate of halving the lifetime with every 5°C rise. When long life performance is required in actual use, the RMS ripple current has to be reduced.

RLN Series

Dimensions (mm)

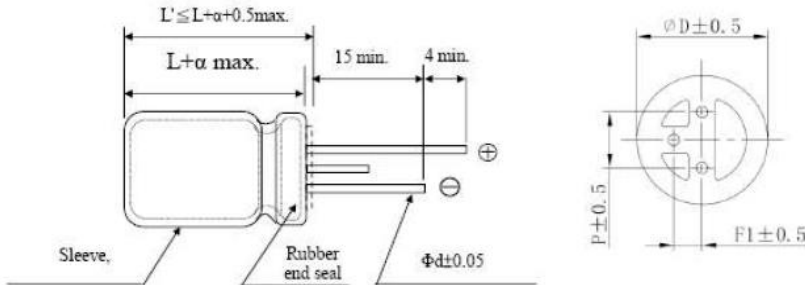

| | | | | |
|-----------|------|------|------|-----|
| ØD | 12.5 | 16 | 18 | 20 |
| P | 5.0 | 7.5 | 7.5 | 10 |
| F1 | 2.5 | 3.75 | 3.75 | 5 |
| A | 2.0 | 2.0 | 2.0 | 2.0 |
| Ød | 0.8 | 0.8 | 0.8 | 1.0 |

Standard Ratings

D x L(mm), R.C.(mA rms) 125°C 100KHz. IMP:(Ω max) at 20°C, 100KHz

| Cap (µF) | V | 10 | | | 16 | | | 25 | | | 35 | | |
|----------|---|-----------|-------|-------|-----------|-------|-------|-----------|-------|-------|------------|-------|-------|
| | | Item | D x L | R.C. | IMP | D x L | R.C. | IMP | D x L | R.C. | IMP | D x L | R.C. |
| 470 | - | - | - | - | - | - | - | - | - | - | 12.5 x 20 | 1830 | 0.055 |
| 1000 | - | - | - | - | - | - | 0.052 | 12.5 x 20 | 1830 | 0.052 | 12.5 x 25 | 2410 | 0.042 |
| | - | - | - | - | - | - | 0.057 | 12.5 x 25 | 2410 | 0.042 | 12.5 x 25 | 3100 | 0.031 |
| 1200 | - | - | - | - | - | - | - | 16 x 16 | 1940 | 0.057 | 16 x 16 | 2490 | 0.038 |
| | - | - | - | - | - | - | - | 12.5 x 20 | 1830 | 0.052 | 12.5 x 30 | 2570 | 0.038 |
| 1500 | - | - | - | - | - | - | - | - | - | - | 16 x 20 | 2290 | 0.042 |
| | - | - | - | - | - | - | - | - | - | - | 12.5 x 35 | 2980 | 0.030 |
| | - | - | - | - | - | - | - | - | - | - | 16 x 31.54 | 3160 | 0.026 |
| 1800 | - | - | - | - | - | - | - | - | - | - | 18 x 25 | 3200 | 0.029 |
| | - | - | - | - | - | - | - | 12.5 x 25 | 2410 | 0.042 | 12.5 x 40 | 3600 | 0.026 |
| | - | - | - | - | - | - | - | 16 x 20 | 2290 | 0.042 | 16 x 25 | 3100 | 0.031 |
| 2200 | - | 12.5 x 25 | 2410 | 0.042 | 12.5 x 25 | 2410 | 0.042 | 12.5 x 30 | 2570 | 0.038 | 16 x 31.5 | 3160 | 0.026 |
| | - | 16 x 20 | - | - | - | 3100 | 0.031 | 16 x 25 | 3100 | 0.031 | 16 x 35.5 | 3590 | 0.025 |
| | - | 18 x 16 | - | - | - | 2490 | 0.038 | 18 x 20 | 2490 | 0.038 | 18 x 25 | 3200 | 0.029 |
| 2700 | - | - | - | - | - | - | - | 12.5 x 35 | 2980 | 0.030 | 16 x 35.5 | 3590 | 0.025 |
| | - | - | - | - | - | - | - | 16 x 25 | 3100 | 0.031 | 18 x 31.5 | 3410 | 0.023 |
| | - | - | - | - | - | - | - | 18 x 20 | 2490 | 0.038 | 20 x 25 | 3500 | 0.029 |
| 3300 | - | 16 x 25 | 3100 | 0.031 | - | 0.026 | 0.026 | 12.5 x 40 | 3600 | 0.026 | 16 x 40 | 4300 | 0.022 |
| | - | 18 x 20 | 2490 | 0.038 | - | 0.029 | 0.029 | 16 x 31.5 | 3160 | 0.026 | 18 x 35.5 | 4000 | 0.022 |
| 3900 | - | - | - | - | - | - | - | 16 x 35.5 | 3590 | 0.025 | - | - | - |
| | - | - | - | - | - | - | - | 18 x 25 | 3200 | 0.029 | - | - | - |
| 4700 | - | 16 x 31.5 | 3160 | 0.026 | 16 x 35.5 | 3590 | 0.025 | 18 x 35.5 | 4200 | 0.022 | - | - | - |
| | - | 18 x 25 | 3200 | 0.029 | 18 x 31.5 | 3410 | 0.023 | 20 x 25 | 3500 | 0.029 | 18 x 40 | 4600 | 0.021 |
| 5600 | - | - | - | - | - | - | - | 16 x 40 | 4300 | 0.022 | 20 x 35.5 | 4700 | 0.021 |
| | - | - | - | - | - | - | - | 18 x 13.5 | 4200 | 0.022 | 20 x 40 | 5100 | 0.020 |
| | - | - | - | - | - | - | - | 20 x 30 | 4000 | 0.025 | | | |
| 6800 | - | - | - | - | - | - | - | 18 x 40 | 4600 | 0.021 | - | - | - |
| | - | - | - | - | - | - | - | 20 x 35.5 | 4700 | 0.021 | - | - | - |
| 8200 | - | - | - | - | - | - | - | 20 x 40 | 5100 | 0.020 | - | - | - |

| Cap (μ F) | V Item | 50 | | | 63 | | | 80 | | | 100 | | |
|-------------------|-----------|-----------|------|-------|-----------|------|-------|-----------|------|-------|----------|------|-------|
| | | D x L | R.C. | IMP | D x L | R.C. | IMP | D x L | R.C. | IMP | D x L | R.C. | IMP |
| 220 | | - | - | - | - | - | - | - | - | - | 16 x 20 | 1110 | 0.286 |
| 330 | | - | - | - | - | - | - | - | - | - | 16 x 25 | 1460 | 0.165 |
| 470 | | 12.5 x 20 | 1500 | 0.091 | - | - | - | 16 x 25 | 1500 | 0.151 | 16x 35.5 | 2000 | 0.100 |
| 560 | | - | - | - | - | - | - | 18 x 25 | 1600 | 0.13 | 16 x 40 | 2200 | 0.090 |
| 820 | | 12.5 x 30 | 2150 | 0.049 | 16 x 31.5 | 1910 | 0.104 | 18 x 35.5 | 2180 | 0.081 | 18 x 40 | 2330 | 0.077 |
| 1000 | | 16 x 25 | 2620 | 0.04 | 16 x 35.5 | 2110 | 0.086 | 18 x 40 | 2470 | 0.066 | - | - | - |
| 1800 | | 18 x 31.5 | 3140 | 0.033 | - | - | - | - | - | - | - | - | - |
| 2200 | | 18 x 35.5 | 3510 | 0.029 | - | - | - | - | - | - | - | - | - |

※ 13mm may be replaced by 12.5mm upon customer's request.

RLK Series

- On the basis of RLA series ripple promotion product
- Suited for LCD TV Power, SMPS.
- RoHS Compliant & Halogen Free

Specifications

| Items | Characteristics | | | | | |
|--|--|---|--------------|------|------|------|
| Capacitance Tolerance | ± 20% (120Hz, 20°C) | | | | | |
| Operating Temperature Range | -40 ~ +105°C | | -25 ~ +105°C | | | |
| Rated Voltage Range | 400VDC | | 450 ~ 500VDC | | | |
| Leakage Current | $I \leq 0.03CV + 20$ (μA) (After 1 minutes application of DC rated voltage, at 20 °C) | | | | | |
| Dissipation Factor | Measurement Frequency: 120Hz. Temperature: 20°C | | | | | |
| | Rated Voltage (V) | 400 | 450 | 460 | 500 | 550 |
| | tan δ(Max) | 0.15 | 0.20 | 0.20 | 0.20 | 0.20 |
| When nominal capacitance over 1000μF, tan δ shall be added 0.02 to the listed value with increase of every 1000μF. | | | | | | |
| Low Temperature Stability | Measurement Frequency: 120Hz. | | | | | |
| | Rated Voltage(V) | 400 | 450 | 460 | 500 | |
| | Z(-25°C)/Z(20°C) | 3 | 3 | 6 | 6 | |
| | Z(-40°C)/Z(20°C) | 6 | - | - | - | |
| Load Life | 2000 hours, with application of rated voltage at 105°C | | | | | |
| | Capacitance Change | Within ± 20% of Initial Value | | | | |
| | tan δ | 200% or less of Initial Specified Value | | | | |
| | Leakage Current | Initial Specified Value or less | | | | |
| Shelf Life | The following specifications shall be satisfied when the capacitors are restored to 20°C after exposing them for 1,000 hours 105°C without voltage applied. Before the measurement the capacitor shall be preconditioned by applying voltage according to them 4.1 of JIS C5101-4. | | | | | |
| | Capacitance Change | Within ± 20% of Initial Value | | | | |
| | tan δ | 200% or less of Initial Specified Value | | | | |
| | Leakage Current | Initial Specified Value or less | | | | |
| Standards | JIS C 5101-4-1 (IEC 60384) | | | | | |

Frequency Coefficient of Permissible Ripple Current

| Capacitance (μF) | Frequency (Hz) | | | | |
|------------------|----------------|------|------|------|------|
| | 120 | 10K | 30K | 50K | 100K |
| 10 ~ 150 | 1.00 | 1.50 | 1.60 | 1.75 | 2.00 |

The endurance of capacitors is reduced with internal heating produced by ripple current at the rate of halving the lifetime with every 5°C rise. When long life performance is required in actual use, the RMS ripple current has to be reduced.

RLK Series

Dimensions (mm)

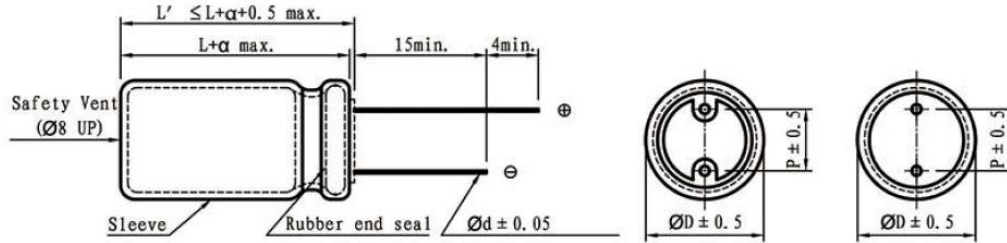

| | | | | | | |
|-----|-----|-----|-----|-----|-----|-----|
| Ø D | 10 | 13 | 16 | 18 | 20 | 22 |
| P | 5.0 | 5.0 | 7.5 | 7.5 | 10 | 10 |
| Ø d | 0.6 | 0.6 | 0.8 | 0.8 | 0.8 | 0.8 |

| | |
|---|--------------|
| α | (L < 16) 1.0 |
| | (L ≥ 16) 2.0 |

Standard Ratings

DxL(mm) ; R.C.(mA rms) at 105°C 120Hz.

| Cap (µF) | V | 400 | | | | 450 | | | | 460 | | | | 500 | | | |
|----------|---|-------|-------|--------|-------|-------|--------|-------|-------|--------|-------|-------|--------|-----|--|--|--|
| | | D x L | R.C. | | D x L | R.C. | | D x L | R.C. | | D x L | R.C. | | | | | |
| | | | 120Hz | 100KHz | | 120Hz | 100KHz | | 120Hz | 100KHz | | 120Hz | 100KHz | | | | |
| 10 | | 10x16 | 120 | 240 | 10x20 | 170 | 340 | 10x20 | 150 | 300 | 13x21 | 83 | 166 | | | | |
| 15 | | 10x20 | 230 | 460 | 13x21 | 230 | 460 | 13x21 | 200 | 400 | 13x21 | 110 | 220 | | | | |
| 22 | | 13x21 | 300 | 600 | 13x21 | 350 | 700 | 13x25 | 350 | 700 | 13x25 | 200 | 400 | | | | |
| 33 | | 13x21 | 380 | 760 | 13x25 | 400 | 800 | 16x25 | 480 | 960 | 16x25 | 300 | 600 | | | | |
| 47 | | 13x25 | 400 | 800 | 16x25 | 530 | 1060 | 18x26 | 530 | 1060 | 18x26 | 330 | 660 | | | | |
| 56 | | 16x25 | 550 | 1100 | 18x26 | 630 | 1260 | 18x26 | 600 | 1200 | 18x32 | 350 | 700 | | | | |
| 68 | | 16x25 | 700 | 1400 | 18x32 | 690 | 1380 | 18x32 | 690 | 1380 | 18x35 | 480 | 960 | | | | |
| 82 | | 18x26 | 780 | 1560 | 18x32 | 750 | 1500 | 18x32 | 750 | 1500 | 18x40 | 590 | 1180 | | | | |
| 100 | | 18x32 | 830 | 1660 | 18x35 | 800 | 1600 | 18x35 | 800 | 1600 | 18x45 | 680 | 1360 | | | | |
| 120 | | 18x35 | 900 | 1800 | 18x40 | 950 | 1900 | 18x40 | 950 | 1900 | 20x45 | 730 | 1460 | | | | |
| 150 | | 18x40 | 1000 | 2000 | 18x45 | 1050 | 2100 | 20x45 | 1300 | 2600 | 22x45 | 780 | 1560 | | | | |

※ 13mm may be replaced by 12.5mm upon customer's request.

RLM Series

- 105°C High ripple and Low impedance, long life: 4,000~5,000 hours.
- Suited for LCD TV BLU Inverter, SMPS, IP-Board, Adaptor, etc.
- RoHS Compliant & Halogen Free

Specifications

| Items | Characteristics | | | | | |
|--|--|---|------|------|------|------|
| Capacitance Tolerance | ± 20% (120Hz, 20°C) | | | | | |
| Operating Temperature Range | -40 ~ +105°C | | | | | |
| Rated Voltage Range | 10 ~ 50VDC | | | | | |
| Leakage Current | $I \leq 0.01CV$ or 3 (μA) which is greater. (After 2 minutes application of DC rated voltage, at 20 °C) | | | | | |
| Dissipation Factor | Measurement Frequency: 120Hz. Temperature: 20°C | | | | | |
| | Rated Voltage (V) | 10 | 16 | 25 | 35 | 50 |
| | tan δ(Max) | 0.19 | 0.16 | 0.14 | 0.12 | 0.10 |
| When nominal capacitance over 1000μF, tan δ shall be added 0.02 to the listed value with increase of every 1000μF. | | | | | | |
| Low Temperature Stability | Measurement Frequency: 120Hz. | | | | | |
| | Rated Voltage(V) | 10 | 16 | 25 | 35 | 50 |
| Impedance Ratio (Max) | Z(-25°C)/Z(20°C) | 2 | 2 | 2 | 2 | 2 |
| | Z(-40°C)/Z(20°C) | 3 | 3 | 3 | 3 | 3 |
| Load Life | 5000hours, with application of working voltage at 105°C (ψD ≤ 8mm & Size: 10x13;load life: 4,000 hours) | | | | | |
| | Capacitance Change | Within ± 30% of Initial Value | | | | |
| | tan δ | 200% or less of Initial Specified Value | | | | |
| | Leakage Current | Initial Specified Value or less | | | | |
| Shelf Life | The following specifications shall be satisfied when the capacitors are restored to 20°C after exposing them for 1,000 hours 105°C without voltage applied. Before the measurement the capacitor shall be preconditioned by applying voltage according to them 4.1 of JIS C5101-4. | | | | | |
| | Capacitance Change | Within ± 25% of Initial Value | | | | |
| | tan δ | 200% or less of Initial Specified Value | | | | |
| | Leakage Current | Initial Specified Value or less | | | | |
| Standards | JIS C 5101-4-1 (IEC 60384) | | | | | |

Frequency Coefficient of Permissible Ripple Current

| Capacitance (μF) | Frequency (Hz) | | | |
|------------------|----------------|------|------|------|
| | 120 | 1K | 10K | 100K |
| 100 ~ 270 | 0.40 | 0.75 | 0.90 | 1.00 |
| 330 ~ 680 | 0.50 | 0.85 | 0.94 | 1.00 |
| 820 ~ 1800 | 0.60 | 0.87 | 0.95 | 1.00 |
| 2200 ~ 2700 | 0.75 | 0.90 | 0.95 | 1.00 |

The endurance of capacitors is reduced with internal heating produced by ripple current at the rate of halving the lifetime with every 5°C rise. When long life performance is required in actual use, the RMS ripple current has to be reduced.

RLM Series

Dimensions (mm)

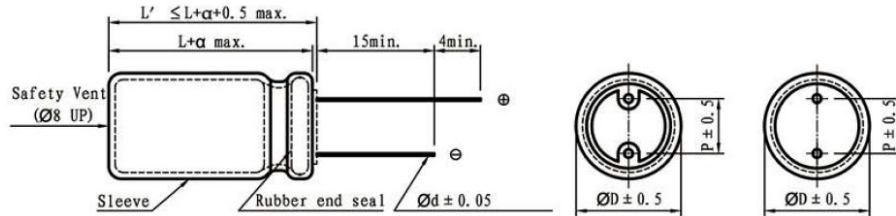

| | | |
|--------------|-----|-----|
| $\text{Ø} D$ | 8 | 10 |
| P | 3.5 | 5.0 |
| $\text{Ø} d$ | 0.5 | 0.6 |

| | |
|----------|-------------------|
| α | (L < 16) 1.0 |
| | (L \geq 16) 2.0 |

Standard

DxL(mm) ; R.C.(mA rms) at 105°C 100KHz ; IMP (Ω max)at 20°C 100KHz.

| Cap (μ F) | V Item | 10 | | | 16 | | | 25 | | |
|----------------|--------|-------|------|-------|-------|------|-------|-------|------|-------|
| | | D x L | R.C. | IMP | D x L | R.C. | IMP | D x L | R.C. | IMP |
| 330 | | | | | | | | 8x12 | 1420 | 0.072 |
| 390 | | | | | | | | 8x16 | 2045 | 0.056 |
| 470 | | | | | 8x12 | 1420 | 0.072 | 10x13 | 2180 | 0.052 |
| 560 | | | | | | | | 8x20 | 2385 | 0.040 |
| 680 | | 8x12 | 1420 | 0.072 | 8x12 | 2045 | 0.056 | 10x16 | 2540 | 0.037 |
| 820 | | | | | 10x13 | 2180 | 0.052 | | | |
| 1000 | | 8x16 | 2045 | 0.056 | 8x20 | 2385 | 0.040 | 10x20 | 2870 | 0.027 |
| 1200 | | 10x13 | 2180 | 0.052 | 10x16 | 2540 | 0.037 | 10x25 | 3165 | 0.023 |
| 1500 | | | | | | | | 10x35 | 3580 | 0.020 |
| 1800 | | 8x20 | 2385 | 0.040 | 10x20 | 2870 | 0.027 | | | |
| 2200 | | 10x16 | 2540 | 0.037 | | | | | | |
| 2700 | | 10x20 | 2870 | 0.027 | 10x25 | 3165 | 0.023 | | | |
| | | 10x25 | 3165 | 0.023 | 10x35 | 3580 | 0.020 | | | |
| | | 10x35 | 3580 | 0.020 | | | | | | |

| Cap (μ F) | V Item | 35 | | | 50 | | |
|----------------|--------|-------|------|-------|-------|------|-------|
| | | D x L | R.C. | IMP | D x L | R.C. | IMP |
| 100 | | | | | 8x12 | 1090 | 0.095 |
| 120 | | | | | 8x16 | 1560 | 0.078 |
| 150 | | | | | 10x13 | 1620 | 0.087 |
| 180 | | | | | 8x20 | 1900 | 0.064 |
| 220 | | 8x12 | 1420 | 0.072 | 10x16 | 1990 | 0.056 |
| 270 | | 8x16 | 2045 | 0.056 | 10x20 | 2330 | 0.041 |
| 330 | | 10x13 | 2180 | 0.052 | 10x25 | 2630 | 0.036 |
| 390 | | 8x20 | 2385 | 0.040 | | | |
| 470 | | 10x16 | 2540 | 0.037 | 10x35 | 2960 | 0.032 |
| 560 | | 10x20 | 2870 | 0.027 | | | |
| 680 | | 10x25 | 3165 | 0.023 | | | |
| 820 | | | | | | | |
| 1000 | | 10x35 | 3580 | 0.020 | | | |

※ 13mm may be replaced by 12.5mm upon customer's request.

RMB Series

- Subminiature product, 105°C
- Applicable to small electronic devices
- Height: 5mm
- RoHS Compliant & Halogen Free

Specifications

| Items | Characteristics | | | | | | | |
|-----------------------------|---|---|------|------|------|------|------|------|
| Capacitance Tolerance | ± 20% (120Hz, 20°C) | | | | | | | |
| Operating Temperature Range | -40 ~ +105°C | | | | | | | |
| Rated Voltage Range | 4 ~ 50VDC | | | | | | | |
| Leakage Current | I ≤ 0.01CV or 3 (μA) which is greater. (After 2 minutes application of DC rated voltage, at 20 °C) | | | | | | | |
| Dissipation Factor | Measurement Frequency: 120Hz. Temperature: 20°C | | | | | | | |
| | Rated Voltage (V) | 4 | 6.3 | 10 | 16 | 25 | 35 | 50 |
| | tan δ(Max) | 0.35 | 0.24 | 0.20 | 0.16 | 0.15 | 0.14 | 0.13 |
| Low Temperature Stability | Measurement Frequency: 120Hz. | | | | | | | |
| | Rated Voltage(V) | 4 | 6.3 | 10 | 16 | 25 | 35 | 50 |
| Impedance Ratio (Max) | Z(-25°C) / Z(20°C) | 6 | 3 | 3 | 2 | 2 | 2 | 2 |
| | Z(-40°C) / Z(20°C) | 12 | 8 | 5 | 4 | 3 | 3 | 3 |
| Load Life | 1000hours, with application of rated voltage at 105°C | | | | | | | |
| | Capacitance Change | Within ± 20% of Initial Value | | | | | | |
| | tan δ | 200% or less of Initial Specified Value | | | | | | |
| | Leakage Current | Initial Specified Value or less | | | | | | |
| Shelf Life | The following specifications shall be satisfied when the capacitors are restored to 20°C after exposing them for 1,000 hours 105°C without voltage applied. Before the measurement, the capacitor shall be preconditioned by applying voltage according to them 4.1 of JIS C5101-4. | | | | | | | |
| | Capacitance Change | Within ± 20% of Initial Value | | | | | | |
| | tan δ | 200% or less of Initial Specified Value | | | | | | |
| | Leakage Current | Initial Specified Value or less | | | | | | |
| Standards | JIS C 5101-4 (IEC 60384) | | | | | | | |

Frequency Coefficient of Permissible Ripple Current

| Capacitance (μF) | Frequency (Hz) | | | |
|------------------|----------------|------|------|-------|
| | 50 | 120 | 1K | ≥ 10K |
| < 100 | 0.80 | 1.00 | 1.30 | 1.50 |
| ≥ 100 | 0.80 | 1.00 | 1.15 | 1.20 |

The endurance of capacitors is reduced with internal heating produced by ripple current at the rate of having the lifetime with every 5°C rise. When long life performance is required in actual use, the rms ripple current has to be reduced.

RMB Series

Dimensions (mm)

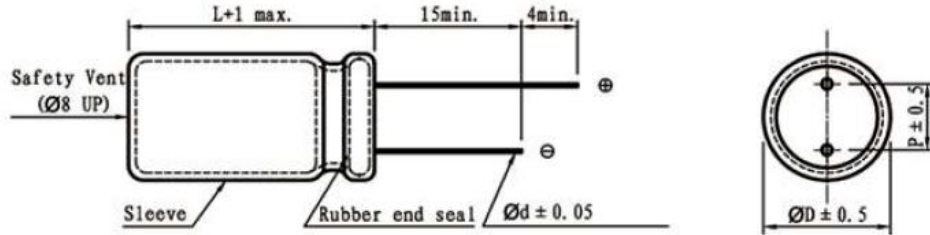

| | | | | |
|-----------------|------|------|------|------|
| $\varnothing D$ | 4 | 5 | 6.3 | 8 |
| P | 1.5 | 2.0 | 2.5 | 2.5 |
| $\varnothing d$ | 0.45 | 0.45 | 0.45 | 0.45 |

Standard Ratings

DxL(mm) ; R.C.(mA rms) at 105°C 120Hz.

| Cap (μF) | V | 4 | | 6.3 | | 10 | | 16 | |
|--------------------|------|-------|------|-------|------|-------|------|-------|------|
| | Item | D x L | R.C. | D x L | R.C. | D x L | R.C. | D x L | R.C. |
| 10 | | | | | | 4x5 | 16 | 4x5 | 18 |
| 22 | | 4x5 | 20 | 4x5 | 21 | 4x5 | 25 | 4x5 | 33 |
| 33 | | 5x5 | 28 | 5x5 | 29 | 5x5 | 34 | 5x5 | 44 |
| 47 | | 5x5 | 33 | 5x5 | 34 | 6.3x5 | 46 | 6.3x5 | 52 |
| 100 | | 6.3x5 | 60 | 6.3x5 | 66 | 6.3x5 | 77 | 8x5 | 93 |
| 150 | | 6.3x5 | 67 | 6.3x5 | 75 | 8x5 | 100 | 8x5 | 115 |
| 220 | | 8x5 | 95 | 8x5 | 115 | 8x5 | 125 | | |

| Cap (μF) | V | 25 | | 35 | | 50 | |
|--------------------|------|-------|------|-------|------|-------|------|
| | Item | D x L | R.C. | D x L | R.C. | D x L | R.C. |
| 0.1 | | | | | | 4x5 | 1.0 |
| 0.22 | | | | | | 4x5 | 2.0 |
| 0.33 | | | | | | 4x5 | 3.0 |
| 0.47 | | | | | | 4x5 | 3.7 |
| 1 | | | | | | 4x5 | 6.2 |
| 2.2 | | | | | | 4x5 | 10 |
| 3.3 | | | | 4x5 | 11 | 4x5 | 14 |
| 4.7 | | 4x5 | 13 | 4x5 | 16 | 5x5 | 18 |
| 10 | | 4x5 | 22 | 5x5 | 25 | 6.3x5 | 28 |
| 22 | | 6.3x5 | 38 | 6.3x5 | 46 | 6.3x5 | 59 |
| 33 | | 6.3x5 | 48 | 6.3x5 | 50 | 8x5 | 65 |
| 47 | | 6.3x5 | 58 | 8x5 | 69 | 8x5 | 78 |

RMC Series

- Subminiature product, Low impedance, 105°C
- Applicable to small electronic devices
- Height: 5mm
- RoHS Compliant & Halogen Free

Specifications

| Items | Characteristics | | | | | | |
|-----------------------------|---|---|------|------|------|-------|------|
| Capacitance Tolerance | ± 20% (120Hz, 20°C) | | | | | | |
| Operating Temperature Range | -40 ~ +105°C | | | | | | |
| Rated Voltage Range | 6.3 ~ 35VDC | | | | | | |
| Leakage Current | $I \leq 0.01CV$ or 3 (μA) which is greater. (After 2 minutes application of DC rated voltage, at 20 °C) | | | | | | |
| Dissipation Factor | Measurement Frequency: 120Hz. Temperature: 20°C | | | | | | |
| | Rated Voltage (V) | 6.3 | 10 | 16 | 25 | 35 | 50 |
| | tan δ(Max) | 0.22 | 0.20 | 0.18 | 0.14 | 0.12 | 0.10 |
| Low Temperature Stability | Measurement Frequency: 120Hz. | | | | | | |
| | Rated Voltage(V) | 6.3 | 10 | 16 | 25 | 35~50 | |
| Impedance Ratio (Max) | Z(-25°C)/Z(20°C) | 2 | 2 | 2 | 2 | 2 | |
| | Z(-40°C)/Z(20°C) | 4 | 4 | 3 | 3 | 3 | |
| Load Life | 1000 hours, with application of rated voltage at 105°C | | | | | | |
| | Capacitance Change | Within ± 20% of Initial Value | | | | | |
| | tan δ | 200% or less of Initial Specified Value | | | | | |
| | Leakage Current | Initial Specified Value or less | | | | | |
| Shelf Life | The following specifications shall be satisfied when the capacitors are restored to 20°C after exposing them for 1,000 hours 105°C without voltage applied. Before the measurement, the capacitor shall be preconditioned by applying voltage according to them 4.1 of JIS C5101-4. | | | | | | |
| | Capacitance Change | Within ± 20% of Initial Value | | | | | |
| | tan δ | 200% or less of Initial Specified Value | | | | | |
| | Leakage Current | Initial Specified Value or less | | | | | |
| Standards | JIS C 5101-4 (IEC 60384) | | | | | | |

Frequency Coefficient of Permissible Ripple Current

| Frequency (Hz) | 50 | 120 | 300 | 1K | 10K ~ 100K |
|----------------|------|------|------|------|------------|
| Coefficient | 0.50 | 0.65 | 0.70 | 0.90 | 1.00 |

The endurance of capacitors is reduced with internal heating produced by ripple current at the rate of halving the lifetime with every 5°C rise. When long life performance is required in actual use, the rms ripple current has to be reduced.

Aluminum Electrolytic Capacitors

RMC Series

Dimensions (mm)

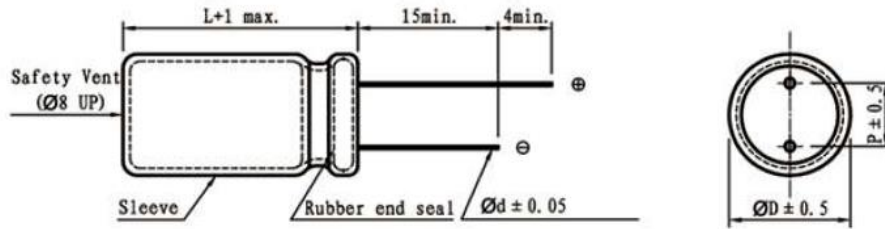

| | | | |
|----|------|------|------|
| ØD | 4 | 5 | 6.3 |
| P | 1.5 | 2.0 | 2.5 |
| Ød | 0.45 | 0.45 | 0.45 |

Standard Ratings

DxL(mm); R.C.(mA rms) at 105°C 100KHz, IMP (Ω max) at 20°C 100KHz.

| Cap (µF) | V | 6.3 | | | 10 | | | 16 | | |
|----------|------|-------|------|-----|-------|------|-----|-------|------|-----|
| | Item | D x L | R.C. | IMP | D x L | R.C. | IMP | D x L | R.C. | IMP |
| 10 | | | | | | | | 4x5 | 55 | 5.0 |
| 15 | | | | | | | | 5x5 | 80 | 2.6 |
| 22 | | 4x5 | 52 | 5.0 | 5x5 | 80 | 2.6 | 5x5 | 82 | 2.5 |
| 33 | | 5x5 | 82 | 2.5 | 5x5 | 82 | 2.5 | 6.3x5 | 113 | 1.3 |
| 47 | | 5x5 | 85 | 2.5 | 6.3x5 | 115 | 1.2 | 6.3x5 | 115 | 1.2 |
| 68 | | 6.3x5 | 118 | 1.3 | | | | | | |
| 100 | | 6.3x5 | 120 | 1.2 | | | | | | |

| Cap (µF) | V | 25 | | | 35 | | |
|----------|------|-------|------|-----|-------|------|-----|
| | Item | D x L | R.C. | IMP | D x L | R.C. | IMP |
| 1 | | | | | 4x5 | 48 | 5.0 |
| 1.5 | | | | | 4x5 | 49 | 4.9 |
| 2.2 | | | | | 4x5 | 50 | 4.9 |
| 3.3 | | | | | 4x5 | 52 | 4.8 |
| 4.7 | | 4x5 | 49 | 5.0 | 4x5 | 55 | 4.8 |
| 6.8 | | 4x5 | 52 | 4.8 | 5x5 | 80 | 2.6 |
| 10 | | 5x5 | 82 | 2.5 | 5x5 | 85 | 2.5 |
| 15 | | 6.3x5 | 116 | 1.3 | 6.3x5 | 116 | 1.3 |
| 22 | | 6.3x5 | 118 | 1.2 | 6.3x5 | 118 | 1.2 |
| 33 | | 6.3x5 | 120 | 1.1 | | | |

RME Series

- Miniature product, 105°C
- Applicable to small electronic devices
- Height: 7 mm
- RoHS Compliant & Halogen Free

Specifications

| Items | Characteristics | | | | | | | | | |
|-----------------------------|---|---|------|------|------|------|------|------|------|------|
| Capacitance Tolerance | ± 20% (120Hz, 20°C) | | | | | | | | | |
| Operating Temperature Range | -40 ~ +105°C | | | | | | | | | |
| Rated Voltage Range | 6.3 ~ 50VDC | | | | | | | | | |
| Leakage Current | $I \leq 0.01CV$ or 3 (μA) which is greater. (After 2 minutes application of DC rated voltage, at 20 °C) | | | | | | | | | |
| Dissipation Factor | Measurement Frequency: 120Hz. Temperature: 20°C | | | | | | | | | |
| | Rated Voltage (V) | 2.7 | 6.3 | 10 | 16 | 25 | 35 | 50 | 63 | 100 |
| | tan δ(Max) | 0.25 | 0.24 | 0.20 | 0.16 | 0.15 | 0.12 | 0.10 | 0.09 | 0.07 |
| Low Temperature Stability | Measurement Frequency: 120Hz. | | | | | | | | | |
| | Rated Voltage(V) | 6.3 | 10 | 16 | 25 | 35 | 50 | | | |
| Impedance Ratio (Max) | Z(-25°C) / Z(20°C) | 3 | 2 | 2 | 2 | 2 | 2 | 2 | 2 | 2 |
| | Z(-40°C) / Z(20°C) | 6 | 5 | 4 | 4 | 3 | 3 | 3 | 3 | 3 |
| Load Life | 1000hours, with application of rated voltage at 105°C | | | | | | | | | |
| | Capacitance Change | Within ± 20% of Initial Value | | | | | | | | |
| | tan δ | 200% or less of Initial Specified Value | | | | | | | | |
| | Leakage Current | Initial Specified Value or less | | | | | | | | |
| Shelf Life | The following specifications shall be satisfied when the capacitors are restored to 20°C after exposing them for 1,000 hours 105°C without voltage applied. Before the measurement, the capacitor shall be preconditioned by applying voltage according to them 4.1 of JIS C5101-4. | | | | | | | | | |
| | Capacitance Change | Within ± 20% of Initial Value | | | | | | | | |
| | tan δ | 200% or less of Initial Specified Value | | | | | | | | |
| | Leakage Current | Initial Specified Value or less | | | | | | | | |
| Standards | JIS C 5101-4 (IEC 60384) | | | | | | | | | |

Frequency Coefficient of Permissible Ripple Current

| Capacitance (μF) | Frequency (Hz) | | | |
|------------------|----------------|------|------|-------|
| | 50 | 120 | 1K | ≥ 10K |
| < 100 | 0.80 | 1.00 | 1.30 | 1.50 |
| ≥ 100 | 0.80 | 1.00 | 1.15 | 1.20 |

The endurance of capacitors is reduced with internal heating produced by ripple current at the rate of halving the lifetime with every 5°C rise. When long life performance is required in actual use, the rms ripple current has to be reduced.

RME Series

Dimensions (mm)

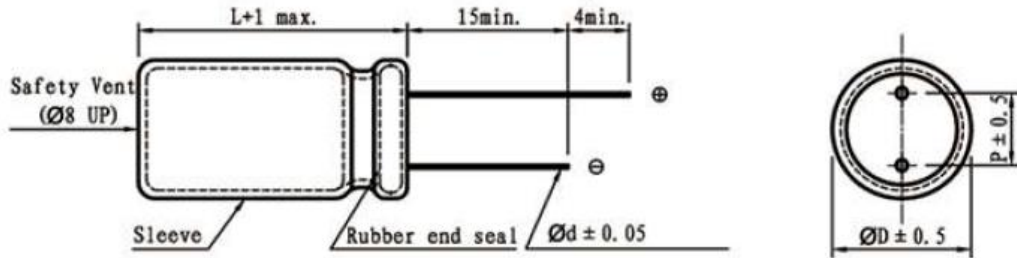

| | | | | |
|----|------|-----|-----|-----|
| ØD | 4 | 5 | 6.3 | 8 |
| P | 1.5 | 2.0 | 2.5 | 3.5 |
| Ød | 0.45 | 0.5 | 0.5 | 0.5 |

Standard Ratings

DxL(mm) ; R.C.(mA rms) at 105°C 120Hz.

| Cap (µF) | V | 6.3 | | 10 | | 16 | |
|----------|------|-------|------|-------|------|-------|------|
| | Item | D x L | R.C. | D x L | R.C. | D x L | R.C. |
| 10 | | | | | | 4x7 | 28 |
| 22 | | 4x7 | 34 | 4x7 | 37 | 4x7 | 44 |
| 33 | | 4x7 | 42 | 4x7 | 45 | 5x7 | 52 |
| 47 | | 4x7 | 50 | 5x7 | 60 | 5x7 | 69 |
| 100 | | 5x7 | 75 | 6.3x7 | 86 | 6.3x7 | 95 |
| 220 | | 6.3x7 | 95 | 8x7 | 145 | 8x7 | 150 |
| 330 | | 8x7 | 160 | | | | |

| Cap (µF) | V | 25 | | 35 | | 50 | |
|----------|------|-------|------|-------|------|-------|------|
| | Item | D x L | R.C. | D x L | R.C. | D x L | R.C. |
| 0.1 | | | | | | 4x7 | 1.0 |
| 0.22 | | | | | | 4x7 | 2.3 |
| 0.33 | | | | | | 4x7 | 3.5 |
| 0.47 | | | | | | 4x7 | 5.0 |
| 1 | | | | | | 4x7 | 10 |
| 2.2 | | | | | | 4x7 | 18 |
| 3.3 | | | | 4x7 | 18 | 4x7 | 24 |
| 4.7 | | 4x7 | 22 | 4x7 | 22 | 4x7 | 28 |
| 10 | | 4x7 | 29 | 5x7 | 33 | 5x7 | 42 |
| 22 | | 5x7 | 35 | 6.3x7 | 55 | 6.3x7 | 60 |
| 33 | | 6.3x7 | 62 | 6.3x7 | 65 | 8x7 | 68 |
| 47 | | 8x7 | 75 | 8x7 | 80 | 8x7 | 95 |
| 100 | | 8x7 | 95 | | | | |
| 150 | | 8x7 | 105 | | | | |
| 180 | | 8x7 | 120 | | | | |

RMG Series

- Miniature, Low impedance, 105°C product
- Applicable to small electronic devices
- Height: 7 mm
- RoHS Compliant & Halogen Free

Specifications

| Items | Characteristics | | | | | | | | |
|-----------------------------|---|---|------|------|------|------|-------|------|------|
| Capacitance Tolerance | ± 20% (120Hz, 20°C) | | | | | | | | |
| Operating Temperature Range | -40 ~ +105°C | | | | | | | | |
| Rated Voltage Range | 6.3 ~ 35VDC | | | | | | | | |
| Leakage Current | $I \leq 0.01CV$ or 3 (μA) which is greater. (After 2 minutes application of DC rated voltage, at 20 °C) | | | | | | | | |
| Dissipation Factor | Measurement Frequency: 120Hz. Temperature: 20°C | | | | | | | | |
| | Rated Voltage (V) | 6.3 | 10 | 16 | 25 | 35 | 40~50 | 63 | 100 |
| | tan δ(Max) | 0.18 | 0.16 | 0.14 | 0.12 | 0.12 | 0.10 | 0.09 | 0.07 |
| Low Temperature Stability | Measurement Frequency: 120Hz. | | | | | | | | |
| | Rated Voltage(V) | 6.3 | 10 | 16 | 25 | 35 | 40~50 | 63 | 100 |
| Impedance Ratio (Max) | Z(-25°C)/Z(20°C) | 2 | 2 | 2 | 2 | 2 | 2 | 2 | 2 |
| | Z(-40°C)/Z(20°C) | 3 | 3 | 3 | 3 | 3 | 3 | 3 | 3 |
| Load Life | 1,000 hours, with application of working voltage at 105°C. | | | | | | | | |
| | Capacitance Change | Within ± 20% of Initial Value | | | | | | | |
| | tan δ | 200% or less of Initial Specified Value | | | | | | | |
| | Leakage Current | Initial Specified Value or less | | | | | | | |
| Shelf Life | The following specifications shall be satisfied when the capacitors are restored to 20°C after exposing them for 1,000 hours 105°C without voltage applied. Before the measurement, the capacitor shall be preconditioned by applying voltage according to them 4.1 of JIS C5101-4. | | | | | | | | |
| | Capacitance Change | Within ± 20% of Initial Value | | | | | | | |
| | tan δ | 200% or less of Initial Specified Value | | | | | | | |
| | Leakage Current | Initial Specified Value or less | | | | | | | |
| Standards | JIS C 5101-4 (IEC 60384) | | | | | | | | |

Frequency Coefficient of Permissible Ripple Current

| Frequency (Hz) | 50 | 120 | 300 | 1K | 10K ~ 100K |
|----------------|------|------|------|------|------------|
| Coefficient | 0.35 | 0.50 | 0.64 | 0.83 | 1.00 |

The endurance of capacitors is reduced with internal heating produced by ripple current at the rate of halving the lifetime with every 5°C rise. When long life performance is required in actual use, the rms ripple current has to be reduced.

RMG Series

Dimensions (mm)

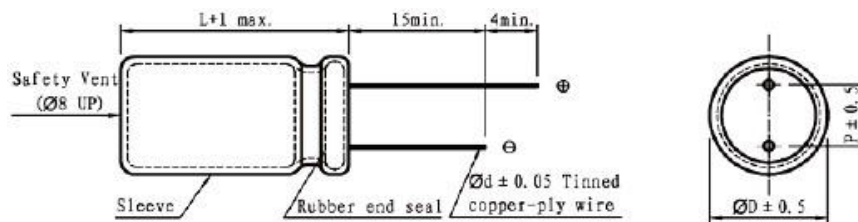

| | | | | |
|-------------|------|-----|-----|-----|
| ØD | 4 | 5 | 6.3 | 8 |
| P | 1.5 | 2.0 | 2.5 | 3.5 |
| Ød | 0.45 | 0.5 | 0.5 | 0.5 |

Standard Ratings

DxL(mm) ; R.C.(mA rms) at 105°C 100KHz, IMP (Ω max) at 20°C 100KHz.

| Cap (μF) | V | 6.3 | | | 10 | | | 16 | | |
|--------------------------|------|-------|------|-----|-------|------|-----|-------|------|-----|
| | Item | D x L | R.C. | IMP | D x L | R.C. | IMP | D x L | R.C. | IMP |
| 15 | | | | | | | | 4x7 | 70 | 3.3 |
| 22 | | | | | 4x7 | 70 | 3.3 | 5x7 | 110 | 1.7 |
| 33 | | 5x7 | 110 | 1.7 | 5x7 | 115 | 1.7 | 6.3x7 | 160 | 0.8 |
| 47 | | 5x7 | 110 | 1.7 | 5x7 | 143 | 1.3 | 6.3x7 | 165 | 0.8 |
| 68 | | 6.3x7 | 160 | 0.8 | 6.3x7 | 165 | 0.8 | 8x7 | 200 | 0.5 |
| 100 | | 6.3x7 | 160 | 0.8 | 8x7 | 200 | 0.5 | 8x7 | 210 | 0.5 |
| 150 | | 8x7 | 200 | 0.5 | 8x7 | 205 | 0.5 | | | |
| 220 | | 8x7 | 200 | 0.5 | | | | | | |

| Ca P (μF) | V | 25 | | | 35 | | |
|------------------------------|------|-------|------|-----|-------|------|-----|
| | Item | D x L | R.C. | IMP | D x L | R.C. | IMP |
| 6.8 | | | | | 4x7 | 70 | 3.3 |
| 10 | | 4x7 | 70 | 3.3 | 5x7 | 110 | 1.7 |
| 15 | | 5x7 | 110 | 1.7 | 6.3x7 | 132 | 1.7 |
| 22 | | 5x7 | 110 | 1.7 | 6.3x7 | 160 | 0.8 |
| 33 | | 6.3x7 | 160 | 0.8 | 8x7 | 200 | 0.5 |
| 47 | | 8x7 | 200 | 0.5 | 8x7 | 230 | 0.5 |
| 68 | | 8x7 | 200 | 0.5 | | | |
| 100 | | 8x7 | 300 | 0.4 | | | |

RMH Series

- Miniature, long life 5000 hours, 105°C product
- Applicable to small electronic devices
- Height: 7 mm
- RoHS Compliant & Halogen Free

Specifications

| Items | Characteristics | | | | | | |
|-----------------------------|---|---|------|------|------|------|------|
| Capacitance Tolerance | ± 20% (120Hz, 20°C) | | | | | | |
| Operating Temperature Range | -40 ~ +105°C | | | | | | |
| Rated Voltage Range | 6.3 ~ 50VDC | | | | | | |
| Leakage Current | I ≤ 0.01CV or 3 (μA) which is greater. (After 2 minutes application of DC rated voltage, at 20 °C) | | | | | | |
| Dissipation Factor | Measurement Frequency: 120Hz. Temperature: 20°C | | | | | | |
| | Rated Voltage (V) | 6.3 | 10 | 16 | 25 | 35 | 50 |
| | tan δ(Max) | 0.24 | 0.20 | 0.17 | 0.15 | 0.13 | 0.12 |
| Low Temperature Stability | Measurement Frequency: 120Hz. | | | | | | |
| | Rated Voltage(V) | 6.3 | 10 | 16 | 25 | 35 | 50 |
| Impedance Ratio (Max) | Z(-25°C) / Z(20°C) | 4 | 3 | 2 | 2 | 2 | 2 |
| | Z(-40°C) / Z(20°C) | 8 | 6 | 4 | 3 | 3 | 3 |
| Load Life | 5,000 hours, with application of rated voltage at 105°C. | | | | | | |
| | Capacitance Change | Within ± 30% of Initial Value | | | | | |
| | tan δ | 300% or less of Initial Specified Value | | | | | |
| | Leakage Current | Initial Specified Value or less | | | | | |
| Shelf Life | The following specifications shall be satisfied when the capacitors are restored to 20°C after exposing them for 1,000 hours 105°C without voltage applied. Before the measurement, the capacitor shall be preconditioned by applying voltage according to them 4.1 of JIS C5101-4. | | | | | | |
| | Capacitance Change | Within ± 30% of Initial Value | | | | | |
| | tan δ | 300% or less of Initial Specified Value | | | | | |
| | Leakage Current | Initial Specified Value or less | | | | | |
| Standards | JIS C 5101-4 (IEC 60384) | | | | | | |

Frequency Coefficient of Permissible Ripple Current

| Frequency (Hz) | 50 | 120 | 1K | ≥10K |
|----------------|------|------|------|------|
| Coefficient | 0.65 | 1.00 | 1.37 | 1.50 |

The endurance of capacitors is reduced with internal heating produced by ripple current at the rate of halving the lifetime with every 5°C rise. When long life performance is required in actual use, the rms ripple current has to be reduced.

RMH Series

Dimensions (mm)

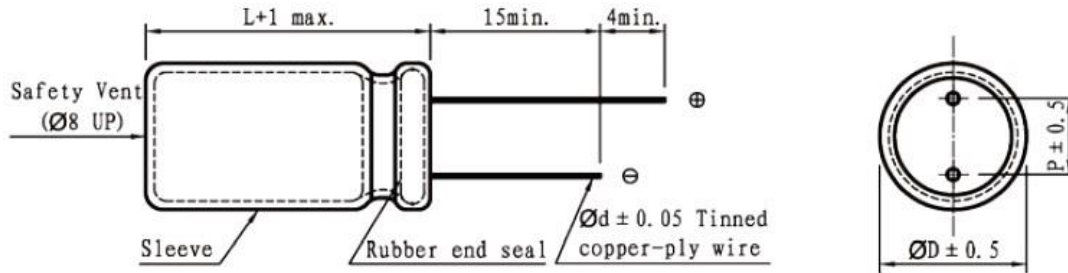

| | | | | |
|----|------|-----|-----|-----|
| ØD | 4 | 5 | 6.3 | 8 |
| P | 1.5 | 2.0 | 2.5 | 3.5 |
| Ød | 0.45 | 0.5 | 0.5 | 0.5 |

Standard Ratings

DxL(mm); R.C.(mA rms) at 105°C 120Hz.

| Cap (µF) | V | 6.3 | | 10 | | 16 | |
|----------|------|-------|------|-------|------|-------|------|
| | Item | D x L | R.C. | D x L | R.C. | D x L | R.C. |
| 10 | | | | | | 4x7 | 29 |
| 22 | | 4x7 | 35 | 5x7 | 42 | 5x7 | 46 |
| 33 | | 5x7 | 43 | 5x7 | 50 | 6.3x7 | 58 |
| 47 | | 5x7 | 50 | 6.3x7 | 60 | 6.3x7 | 70 |
| 100 | | 6.3x7 | 76 | 8x7 | 96 | 8x7 | 110 |
| 220 | | 8x7 | 131 | | | | |

| Cap (µF) | V | 25 | | 35 | | 50 | |
|----------|------|-------|------|-------|------|-------|------|
| | Item | D x L | R.C. | D x L | R.C. | D x L | R.C. |
| 0.1 | | | | | | 4x7 | 1.5 |
| 0.22 | | | | | | 4x7 | 2.5 |
| 0.33 | | | | | | 4x7 | 3.5 |
| 0.47 | | | | | | 4x7 | 5 |
| 1 | | | | | | 4x7 | 12 |
| 2.2 | | | | | | 4x7 | 21 |
| 3.3 | | | | | | 4x7 | 26 |
| 4.7 | | | | 4x7 | 26 | 5x7 | 31 |
| 10 | | 5x7 | 36 | 5x7 | 36 | 6.3x7 | 46 |
| 22 | | 6.3x7 | 52 | 6.3x7 | 60 | 8x7 | 67 |
| 33 | | 6.3x7 | 65 | 8x7 | 75 | | |
| 47 | | 8x7 | 80 | | | | |

RNC Series

- Non-polarity standard product, 85°C 2000 hours.
- Suitable for DC two-way return circuit.
- RoHS Compliant & Halogen Free

Specifications

| Items | Characteristics | | | | | | | | |
|--|---|---|------|------|------|------|------|------|------|
| Capacitance Tolerance | ± 20% (120Hz, 20°C) | | | | | | | | |
| Operating Temperature Range | -40 ~ +85°C | | | | | | | | |
| Rated Voltage Range | 6.3 ~ 100VDC | | | | | | | | |
| Leakage Current | $I \leq 0.03CV$ or 3 (μA) which is greater. (After 5 minutes application of DC rated voltage, at 20°C) | | | | | | | | |
| Dissipation Factor | Measurement Frequency: 120Hz. Temperature: 20°C | | | | | | | | |
| | Rated Voltage (V) | 6.3 | 10 | 16 | 25 | 35 | 50 | 63 | 100 |
| | tan δ(Max) | 0.26 | 0.24 | 0.22 | 0.20 | 0.16 | 0.14 | 0.12 | 0.10 |
| When nominal capacitance over 1000μF, tan δ shall be added 0.02 to the listed value with increase of every 1000μF. | | | | | | | | | |
| Low Temperature Stability Impedance Ratio (Max) | Measurement Frequency: 120Hz. | | | | | | | | |
| | Rated Voltage (V) | 6.3 | 10 | 16 | 25 | 35 | 50 | 63 | 100 |
| | Z(-25°C)/Z(20°C) | 4 | 3 | 2 | 2 | 2 | 2 | 2 | 2 |
| Z(-40°C)/Z(20°C) | 10 | 8 | 6 | 5 | 4 | 4 | 3 | 3 | |
| Load Life | 2,000 hours, with the polarity inverted every 250 hours at 85°C | | | | | | | | |
| | Capacitance Change | Within ±20% of Initial Value | | | | | | | |
| | tan δ | 200% or less of Initial Specified Value | | | | | | | |
| | Leakage Current | Initial Specified Value or less | | | | | | | |
| Shelf Life | The following specifications shall be satisfied when the capacitors are restored to 20°C after exposing them for 1,000 hours 85°C without voltage applied. Before the measurement the capacitor shall be preconditioned by applying voltage according to them 4.1 of JIS C5101-4. | | | | | | | | |
| | Capacitance Change | Within ±20% of Initial Value | | | | | | | |
| | tan δ | 200% or less of Initial Specified Value | | | | | | | |
| | Leakage Current | Initial Specified Value or less | | | | | | | |
| Standards | JIS C 5101-4 (IEC 60384) | | | | | | | | |

Frequency Coefficient of Permissible Ripple Current

| Capacitance (μF) | Frequency (Hz) | | | |
|------------------|----------------|------|------|-------|
| | 50 | 120 | 1K | ≥ 10K |
| < 100 | 0.80 | 1.00 | 1.30 | 1.50 |
| ≥ 100 | 0.80 | 1.00 | 1.15 | 1.20 |

The endurance of capacitors is reduced with internal heating produced by ripple current at the rate of halving the lifetime with every 5°C rise. When long life performance is required in actual use, the RMS ripple current has to be reduced.

RNC Series

Dimensions (mm)

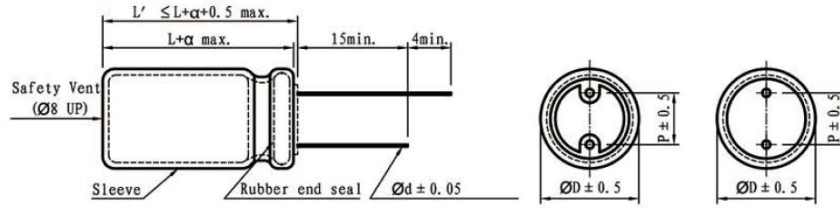

| | | | | | | | | |
|-----|------|-----|-----|-----|-----|-----|-----|-----|
| Ø D | 4 | 5 | 6.3 | 8 | 10 | 13 | 16 | 18 |
| P | 1.5 | 2.0 | 2.5 | 3.5 | 5.0 | 5.0 | 7.5 | 7.5 |
| Ø d | 0.45 | 0.5 | 0.5 | 0.5 | 0.6 | 0.6 | 0.8 | 0.8 |

| | |
|----------|--------------|
| α | (L < 16) 1.0 |
| | (L ≥ 16) 2.0 |

Standard Ratings

DxL(mm); R.C. (mA rms) at 85°C 120Hz.

| Cap (µF) | V | 6.3 | | 10 | | 16 | | 25 | |
|----------|-----|--------|-------|--------|-------|--------|-------|--------|-------|
| | | Item | D x L | R.C. | D x L | R.C. | D x L | R.C. | D x L |
| 4.7 | | | | | | 4x7 | 19 | 5x7 | 22 |
| 10 | | | | 4x7 | 24 | 5x11 | 42 | 5x11 | 45 |
| 22 | | | | 5x7 | 41 | 5x11 | 59 | 6.3x7 | 53 |
| 33 | | | | 5x11 | 57 | 6.3x7 | 51 | 6.3x11 | 66 |
| | | 5x7 | 43 | 5x11 | 67 | 6.3x7 | 64 | 6.3x11 | 88 |
| 47 | | 5x11 | 63 | 6.3x7 | 56 | 6.3x11 | 80 | 8x7 | 74 |
| | | 6.3x7 | 58 | 6.3x7 | 67 | 6.3x7 | 75 | 8x7 | 87 |
| 100 | | 5x11 | 76 | 6.3x11 | 83 | 6.3x11 | 95 | 8x12 | 100 |
| | | 6.3x11 | 125 | 6.3x11 | 128 | 8x7 | 125 | 8x14 | 160 |
| | 8x7 | 96 | 8x7 | 110 | 8x12 | 160 | | | |
| 220 | | 8x7 | 140 | 8x14 | 215 | 10x16 | 300 | 10x16 | 385 |
| | | 8x12 | 210 | | | | | | |
| 330 | | 8x14 | 270 | 10x16 | 350 | 10x16 | 375 | 13x21 | 460 |
| 470 | | 10x16 | 370 | 10x20 | 410 | 10x20 | 480 | 13x21 | 540 |
| 1000 | | 10x20 | 650 | 13x21 | 720 | 13x25 | 855 | 16x26 | 950 |
| 2200 | | 13x25 | 1160 | 16x26 | 1280 | 16x32 | 1510 | 18x35 | 1620 |
| 3300 | | 16x26 | 1570 | 16x32 | 1690 | 18x35 | 1980 | | |
| 4700 | | 16x32 | 2020 | 18x35 | 2160 | | | | |
| 6800 | | 18x35 | 2600 | | | | | | |

RNC Series

Standard Ratings

DxL(mm) ; R.C.(mA rms) at 85°C 120Hz.

| Cap (μF) | V Item | 35 | | 50 | | 63 | | 100 | |
|------------|-----------|--------|------|--------|------|--------|------|--------|------|
| | | D x L | R.C. | D x L | R.C. | D x L | R.C. | D x L | R.C. |
| 0.10 | | | | 4x7 | 4 | | | | |
| 0.22 | | | | 4x7 | 6 | | | | |
| 0.33 | | | | 4x7 | 7.3 | | | | |
| 0.47 | | | | 4x7 | 8.9 | | | | |
| 0.1 ~ 0.47 | | | | 5x11 | 11 | 5x11 | 11 | 5x11 | 14 |
| 1.0 | | | | 4x7 | 12 | 5x11 | 17 | 5x11 | 21 |
| | | | | 5x11 | 17 | | | | |
| 2.2 | | | | 4x7 | 19 | 5x11 | 25 | 6.3x11 | 33 |
| | | | | 5x11 | 25 | | | | |
| 3.3 | | | | 5x7 | 25 | 5x11 | 37 | 6.3x11 | 39 |
| | | 4x7 | 20 | 5x11 | 28 | | | | |
| 4.7 | | 5x7 | 30 | 5x11 | 34 | 6.3x11 | 47 | 8x12 | 57 |
| | | 5x11 | 34 | 6.3x7 | 38 | | | | |
| 10 | | 5x11 | 45 | 6.3x11 | 52 | 8x12 | 68 | 8x14 | 80 |
| | | 6.3x7 | 48 | 8x7 | 54 | | | | |
| 22 | | 6.3x11 | 74 | 8x7 | 66 | 8x14 | 95 | 10x16 | 135 |
| | | 8x7 | 62 | 8x12 | 88 | | | | |
| 33 | | 8x7 | 76 | 8x14 | 105 | 10x16 | 135 | 13x21 | 220 |
| | | 8x12 | 105 | | | | | | |
| 47 | | 8x14 | 125 | 10x16 | 150 | 10x20 | 180 | 13x21 | 240 |
| 100 | | 10x16 | 230 | 10x20 | 265 | 13x21 | 320 | 16x26 | 430 |
| 220 | | 13x21 | 420 | 13x25 | 480 | 16x26 | 570 | 18x35 | 720 |
| 330 | | 13x21 | 510 | 16x26 | 650 | 16x32 | 660 | | |
| 470 | | 13x25 | 660 | 16x32 | 840 | 18x35 | 965 | | |
| 1000 | | 16x32 | 1140 | | | | | | |

※ 13mm may be replaced by 12.5mm upon customer's request.

RND Series

- Non-polarity standard product, 105°C 2000 hours.
- Suitable for DC two-way return circuit.
- RoHS Compliant & Halogen Free

Specifications

| Items | Characteristics | | | | | | | | | |
|--|---|---|------|------|------|------|------|------|------|------|
| Capacitance Tolerance | ± 20% (120Hz, 20°C) | | | | | | | | | |
| Operating Temperature Range | -40 ~ +105°C | | | | | | | | | |
| Rated Voltage Range | 6.3 ~ 160VDC | | | | | | | | | |
| Leakage Current | $I \leq 0.03CV$ or 3 (μA) which is greater. (After 5 minutes application of DC rated voltage, at 20°C) | | | | | | | | | |
| Dissipation Factor | Measurement Frequency: 120Hz. Temperature: 20°C | | | | | | | | | |
| | Rated Voltage (V) | 6.3 | 10 | 16 | 25 | 35 | 50 | 63 | 100 | 160 |
| | tan δ(Max) | 0.26 | 0.24 | 0.22 | 0.20 | 0.16 | 0.14 | 0.12 | 0.10 | 0.15 |
| When nominal capacitance over 1000μF, tan δ shall be added 0.02 to the listed value with increase of every 1000μF. | | | | | | | | | | |
| Low Temperature Stability Impedance Ratio (Max) | Measurement Frequency: 120Hz. | | | | | | | | | |
| | Rated Voltage(V) | 6.3 | 10 | 16 | 25 | 35 | 50 | 63 | 100 | 160 |
| | Z(-25°C)/Z(20°C) | 4 | 3 | 2 | 2 | 2 | 2 | 2 | 2 | 3 |
| | Z(-40°C)/Z(20°C) | 10 | 8 | 6 | 5 | 4 | 4 | 3 | 3 | 4 |
| Load Life | 2,000 hours, with the polarity inverted every 250 hours at 105°C | | | | | | | | | |
| | Capacitance Change | Within ±20% of Initial Value | | | | | | | | |
| | tan δ | 200% or less of Initial Specified Value | | | | | | | | |
| | Leakage Current | Initial Specified Value or less | | | | | | | | |
| Shelf Life | The following specifications shall be satisfied when the capacitors are restored to 20°C after exposing them for 1,000 hours 105°C without voltage applied. Before the measurement, the capacitor shall be preconditioned by applying voltage according to them 4.1 of JIS C5101-4. | | | | | | | | | |
| | Capacitance Change | Within ±20% of Initial Value | | | | | | | | |
| | tan δ | 200% or less of Initial Specified Value | | | | | | | | |
| | Leakage Current | Initial Specified Value or less | | | | | | | | |
| Standards | JIS C 5101-4 (IEC 60384) | | | | | | | | | |

Frequency Coefficient of Permissible Ripple Current

| Capacitance (μF) | Frequency (Hz) | | | |
|------------------|----------------|------|------|-------|
| | 50 | 120 | 1K | ≥ 10K |
| < 100 | 0.80 | 1.00 | 1.30 | 1.50 |
| ≥ 100 | 0.80 | 1.00 | 1.15 | 1.20 |

The endurance of capacitors is reduced with internal heating produced by ripple current at the rate of halving the lifetime with every 5°C rise. When long life performance is required in actual use, the RMS ripple current has to be reduced.

RND Series

Dimensions (mm)

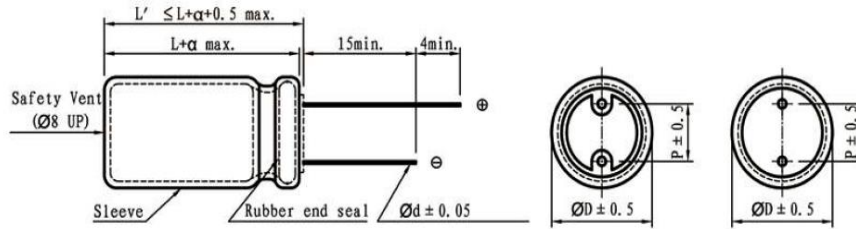

| $\varnothing D$ | 4 | 5 | 6.3 | 8 | 10 | 13 | 16 |
|-----------------|------|-----|-----|-----|-----|-----|-----|
| P | 1.5 | 2.0 | 2.5 | 3.5 | 5.0 | 5.0 | 7.5 |
| $\varnothing d$ | 0.45 | 0.5 | 0.5 | 0.5 | 0.6 | 0.6 | 0.8 |

| α | (L < 16) 1.0 |
|----------|-------------------|
| α | (L \geq 16) 2.0 |

Standard Ratings

DxL(mm) ; R.C.(mA rms) at 105°C 120Hz.

| Cap (μF) | V | 6.3 | | 10 | | 16 | | 25 | |
|-----------------|------|--------|------|--------|------|--------|------|--------|------|
| | Item | D x L | R.C. | D x L | R.C. | D x L | R.C. | D x L | R.C. |
| 3.3 | | | | | | | | 4x7 | 15 |
| 4.7 | | | | | | 4x7 | 18 | 5x7 | 18 |
| 10 | | | | 4x7 | 23 | 5x7 | 27 | 5x11 | 36 |
| | | | | | | 5x11 | 30 | 6.3x7 | 28 |
| 22 | | 5x7 | 33 | 5x7 | 36 | 6.3x7 | 41 | 6.3x11 | 55 |
| | | | | 5x11 | 42 | 6.3x11 | 52 | 8x7 | 42 |
| 33 | | 5x7 | 40 | 6.3x7 | 45 | 6.3x11 | 66 | 8x12 | 75 |
| | | 5x11 | 48 | 6.3x11 | 58 | 8x7 | 52 | | |
| 47 | | 6.3x7 | 49 | 6.3x11 | 70 | 8x12 | 90 | 10x13 | 96 |
| | | 6.3x11 | 65 | 8x7 | 55 | | | | |
| 100 | | 8x12 | 105 | 10x13 | 125 | 10x13 | 140 | 10x16 | 158 |
| 220 | | 10x13 | 168 | 10x16 | 205 | 10x20 | 285 | 13x21 | 306 |
| 330 | | 10x16 | 230 | 10x20 | 278 | 13x21 | 346 | 13x25 | 415 |
| 470 | | 10x20 | 330 | 13x21 | 370 | 13x25 | 460 | 16x26 | 545 |
| 1000 | | 13x25 | 550 | 16x26 | 665 | 16x26 | 750 | 16x32 | 870 |

RND Series

Standard Ratings

DxL(mm) ; R.C.(mA rms) at 105°C 120Hz.

| Cap (μF) | V | 35 | | 50 | | 63 | | 100 | | 160 | |
|------------|------|--------|------|--------|------|--------|------|--------|------|--------|------|
| | Item | D x L | R.C. | D x L | R.C. | D x L | R.C. | D x L | R.C. | D x L | R.C. |
| 0.1 | | | | 4x7 | 2.1 | 4x7 | 2.6 | | | | |
| 0.22 | | | | 4x7 | 4.5 | 4x7 | 5 | | | | |
| 0.33 | | | | 4x7 | 5.6 | 4x7 | 6.1 | | | | |
| 0.47 | | | | 4x7 | 6.6 | 4x7 | 7.3 | | | | |
| 0.1 ~ 0.47 | | | | 5x11 | 8 | 5x11 | 5 | 5x11 | 10 | 6.3x11 | 10 |
| 1 | | | | 4x7 | 9.7 | 4x7 | 10 | 5x11 | 15 | 8x12 | 17 |
| | | | | 5x11 | 12 | 5x11 | 15 | | | | |
| 2.2 | | 4x7 | 13 | 5x7 | 14 | 5x7 | 16 | 6.3x11 | 24 | 8x12 | 20 |
| | | | | | | 5x11 | 18 | | | | |
| 3.3 | | 5x7 | 16 | 5x7 | 18 | 6.3x7 | 20 | 8x12 | 32 | 8x12 | 25 |
| | | | | | | 5x11 | 22 | | | | |
| 4.7 | | 5x7 | 20 | 6.3x7 | 22 | 6.3x11 | 32 | 8x12 | 40 | 8x12 | 30 |
| | | | | | | 5x11 | 25 | | | | |
| 5.6 | | 5x11 | 28 | 6.3x11 | 35 | 6.3x11 | 40 | 8x12 | 48 | 8x14 | 35 |
| 6.8 | | 5x11 | 33 | 6.3x11 | 40 | 8x12 | 45 | 8x14 | 52 | 8x16 | 41 |
| 10 | | 6.3x11 | 40 | 8x12 | 50 | 8x12 | 55 | 10x13 | 65 | 10x16 | 55 |
| | | | | | | | | | | | |
| 22 | | 8x12 | 68 | 10x13 | 82 | 10x16 | 90 | 10x20 | 120 | 13x21 | 106 |
| 33 | | 10x13 | 90 | 10x16 | 100 | 10x20 | 128 | 13x21 | 168 | 13x21 | 130 |
| 47 | | 10x13 | 110 | 10x20 | 146 | 10x20 | 156 | 13x21 | 200 | 13x25 | 167 |
| 56 | | 10x16 | 140 | 13x21 | 195 | 13x21 | 218 | 13x21 | 250 | 16x26 | 206 |
| 100 | | 10x20 | 196 | 13x25 | 260 | 13x25 | 275 | 13x25 | 295 | 16x32 | 300 |
| 220 | | 13x25 | 365 | 16x26 | 445 | 16x32 | 486 | | | | |
| 330 | | 16x26 | 492 | 16x32 | 595 | | | | | | |
| 470 | | 16x32 | 595 | | | | | | | | |

※ 13mm may be replaced by 12.5mm upon customer's request.

RNE Series

- Non-polarity, low E.S.R, ripple current high frequency and high-temperature resistance.
- Suitable for propositive amplifier of high-grade audio and horizontal compensatory return circuit of TV set.
- RoHS Compliant & Halogen Free

Specifications

| Items | Characteristics | | | | |
|---|---|---|----|----|-----|
| Capacitance Tolerance | ± 20% (120Hz, 20°C) | | | | |
| Operating Temperature Range | -40 ~ +105°C | | | | |
| Rated Voltage Range | 25V, 35V, 50V, 100VDC | | | | |
| Leakage Current | After 5 minutes application of DC rated voltage, leakage current is 100μA or less. | | | | |
| Dissipation Factor | 0.05 Max. measured at 120Hz. 20°C | | | | |
| Low Temperature Stability Impedance Ratio (Max) | Measurement Frequency: 120Hz. | | | | |
| | Rated Voltage(V) | 25 | 35 | 50 | 100 |
| | Z(-25°C) / Z(20°C) | 3 | 3 | 3 | 3 |
| | Z(-40°C) / Z(20°C) | 4 | 4 | 4 | 4 |
| Load Life | 1,000 hours, with application of rated voltage at 105°C | | | | |
| | Capacitance Change | Within ± 15% of Initial Value | | | |
| | tan δ | 200% or less of Initial Specified Value | | | |
| | Leakage Current | Initial Specified Value or less | | | |
| Shelf Life | The following specifications shall be satisfied when the capacitors are restored to 20°C after exposing them for 1,000 hours 105°C without voltage applied. Before the measurement, the capacitor shall be preconditioned by applying voltage according to them 4.1 of JIS C5101-4. | | | | |
| | Capacitance Change | Within ± 15% of Initial Value | | | |
| | tan δ | 200% or less of Initial Specified Value | | | |
| | Leakage Current | Initial Specified Value or less | | | |
| Standards | JIS C 5101-4 (IEC 60384) | | | | |

RNE Series

Dimensions (mm)

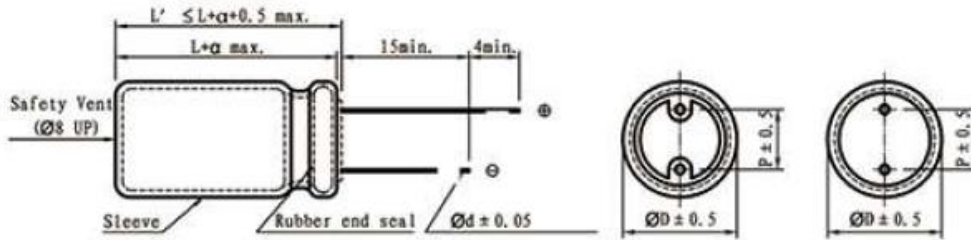

| | | | |
|-----|-----|-----|-----|
| Ø D | 10 | 13 | 16 |
| P | 5.0 | 5.0 | 7.5 |
| Ø d | 0.6 | 0.6 | 0.8 |

Standard Ratings

D x L (mm), R.C. A(p-p) 15.75KHz at 105°C, E.S.R. (Ω) at 20°C 120Hz.

| Cap (µF) | V | 25 | | | 35 | 50 | 100 |
|----------|------|-------|------|-------|-------|------|-------|
| | Item | D x L | R.C. | E.S.R | D x L | R.C. | E.S.R |
| 2.2 | | 10x20 | 2.8 | 30.20 | 13x25 | 3.0 | 30.20 |
| 2.7 | | 13x21 | 3.5 | 24.23 | 13x25 | 4.5 | 24.23 |
| 3.3 | | 13x21 | 4.0 | 20.12 | 16x26 | 5.0 | 20.12 |
| 4.7 | | 13x21 | 5.0 | 14.30 | 16x26 | 6.5 | 14.30 |
| 5.6 | | 13x25 | 6.0 | 9.80 | 16x32 | 6.5 | 9.80 |
| 6.8 | | 16x26 | 7.0 | 8.10 | 16x36 | 7.5 | 8.10 |
| 8.2 | | 16x26 | 7.5 | 7.05 | 16x36 | 8.0 | 7.05 |
| 10 | | 16x32 | 9.0 | 5.60 | | | |

※13mm may be replaced by 12.5mm upon customer's request.

RPB Series

- Low leakage current product.
- Suitable for prepositive amplifier of high-grade audio and oscillating return of TV set.
- RoHS Compliant & Halogen Free

Specifications

| Items | Characteristics | | | | | | | | |
|--|---|---|------|------|------|------|------|------|------|
| Capacitance Tolerance | ± 20% (120Hz, 20°C) | | | | | | | | |
| Operating Temperature Range | -40 ~ +85°C | | | | | | | | |
| Rated Voltage Range | 6.3 ~ 100VDC | | | | | | | | |
| Leakage Current | I ≤ 0.002CV or 0.4 (μA), which is greater. (After 2 minutes application of DC rated voltage, at 20°C) | | | | | | | | |
| Dissipation Factor | Measurement Frequency: 120Hz. Temperature: 20°C | | | | | | | | |
| | Rated Voltage (V) | 6.3 | 10 | 16 | 25 | 35 | 50 | 63 | 100 |
| | tan δ(Max) | 0.24 | 0.20 | 0.16 | 0.15 | 0.12 | 0.10 | 0.09 | 0.08 |
| When nominal capacitance over 1000μF, tan δ shall be added 0.02 to the listed value with increase of every 1000μF. | | | | | | | | | |
| Low Temperature Stability Impedance Ratio (Max) | Measurement Frequency: 120Hz. | | | | | | | | |
| | Rated Voltage(V) | 6.3 | 10 | 16 | 25 | 35 | 50 | 63 | 100 |
| | Z(-25°C)/Z(20°C) | 4 | 3 | 2 | 2 | 2 | 2 | 2 | 2 |
| Z(-40°C)/Z(20°C) | 8 | 6 | 6 | 4 | 4 | 3 | 3 | 3 | |
| Load Life | The following specifications shall be satisfied when the capacitors are restored to 20°C after subjected to DC voltage with the rated ripple current is applied for 1000 hours, at 105°C) | | | | | | | | |
| | Capacitance Change | Within ± 25% of Initial Value | | | | | | | |
| | tan δ | 200% or less of Initial Specified Value | | | | | | | |
| | Leakage Current | Initial Specified Value or less | | | | | | | |
| Shelf Life | The following specifications shall be satisfied when the capacitors are restored to 20°C after exposing them for 1,000 hours 85°C without voltage applied. Before the measurement the capacitor shall be preconditioned by applying voltage according to them 4.1 of JIS C5101-4. | | | | | | | | |
| | Capacitance Change | Within ± 25% of Initial Value | | | | | | | |
| | tan δ | 200% or less of Initial Specified Value | | | | | | | |
| | Leakage Current | Initial Specified Value or less | | | | | | | |
| Standards | JIS C 5101-4(IEC 60384) | | | | | | | | |

Frequency Coefficient of Permissible Ripple Current

| Capacitance (μF) | Frequency (Hz) | | | |
|------------------|----------------|------|------|------|
| | 50 | 120 | 1K | 10K |
| < 100 | 0.80 | 1.00 | 1.30 | 1.50 |
| 100 ~ 1000 | 0.80 | 1.00 | 1.15 | 1.20 |
| > 1000 | 0.80 | 1.00 | 1.10 | 1.15 |

The endurance of capacitors is reduced with internal heating produced by ripple current at the rate of halving the lifetime with every 5°C rise. When long life performance is required in actual use, the RMS ripple current has to be reduced.

RPB Series

Dimensions (mm)

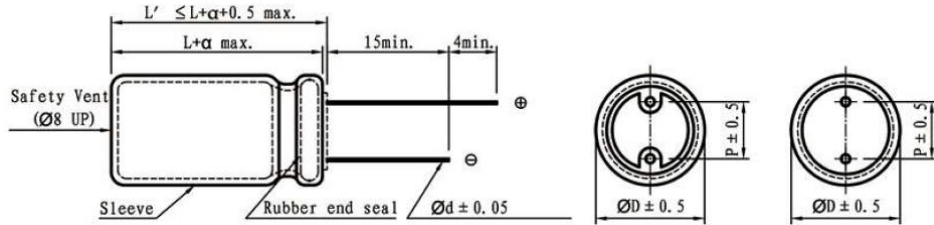

| | | | | | | | |
|----|-----|-----|-----|-----|-----|-----|-----|
| ØD | 5 | 6.3 | 8 | 10 | 13 | 16 | 18 |
| P | 2.0 | 2.5 | 3.5 | 5.0 | 5.0 | 7.5 | 7.5 |
| Ød | 0.5 | 0.5 | 0.5 | 0.6 | 0.6 | 0.8 | 0.8 |

| | |
|---|--------------|
| α | (L < 16) 1.0 |
| | (L ≥ 16) 2.0 |

Standard Ratings

DxL(mm) ; R.C.(mA rms) at 85°C 120Hz.

| Cap (µF) | V | 6.3 | | 10 | | 16 | | 25 | |
|----------|---|-------|-------|--------|-------|--------|-------|--------|-------|
| | | Item | D x L | R.C. | D x L | R.C. | D x L | R.C. | D x L |
| 4.7 | | | | | | | | 5x11 | 45 |
| 6.8 | | | | | | | | 5x11 | 55 |
| 10 | | | | | | 5x11 | 55 | 5x11 | 70 |
| 15 | | | | | | 5x11 | 70 | 5x11 | 85 |
| 22 | | | | | | 5x11 | 85 | 5x11 | 100 |
| 33 | | | | | | 5x11 | 100 | 6.3x11 | 140 |
| 47 | | | | 5x11 | 100 | 6.3x11 | 140 | 6.3x11 | 170 |
| 68 | | | | 6.3x11 | 150 | 6.3x11 | 160 | 8x12 | 230 |
| 100 | | | | 6.3x11 | 180 | 8x12 | 230 | 8x12 | 280 |
| 150 | | | | 8x12 | 250 | 8x12 | 280 | 10x13 | 370 |
| 220 | | | | 8x12 | 310 | 10x13 | 370 | 10x16 | 400 |
| 330 | | | | 10x13 | 400 | 10x16 | 420 | 10x20 | 490 |
| 470 | | 10x13 | 385 | 10x16 | 530 | 10x16 | 550 | 10x20 | 650 |
| 680 | | 10x13 | 480 | 10x16 | 600 | 10x20 | 720 | 13x21 | 800 |
| 1000 | | 10x16 | 640 | 10x20 | 780 | 13x21 | 900 | 13x25 | 1000 |
| 1500 | | 10x20 | 900 | 13x25 | 1020 | 16x26 | 1150 | 16x32 | 1270 |
| 2200 | | 13x21 | 1050 | 13x25 | 1200 | 16x26 | 1300 | 16x36 | 1440 |
| 3300 | | 16x26 | 1300 | 16x32 | 1420 | 16x36 | 1550 | 18x40 | 1720 |
| 4700 | | 16x32 | 1500 | 16x36 | 1650 | 18x35 | 1820 | | |

※ 13mm may be replaced by 12.5mm upon customer's request.

RPB Series

Standard Ratings

DxL(mm) ; R.C.(mA rms) at 85°C 120Hz.

| Cap (μF) | V | 35 | | 50 | | 63 | | 100 | |
|----------|------|--------|------|--------|------|--------|------|--------|------|
| | Item | D x L | R.C. | D x L | R.C. | D x L | R.C. | D x L | R.C. |
| 0.1 | | | | 5x11 | 1.1 | | | 5x11 | 2.1 |
| 0.15 | | | | 5x11 | 1.6 | | | 5x11 | 3.2 |
| 0.22 | | | | 5x11 | 2.3 | | | 5x11 | 4.7 |
| 0.33 | | | | 5x11 | 3.5 | | | 5x11 | 7.0 |
| 0.47 | | | | 5x11 | 5.0 | | | 5x11 | 10.1 |
| 0.68 | | | | 5x11 | 7.3 | | | 5x11 | 14.5 |
| 1 | | | | 5x11 | 10.7 | | | 5x11 | 19 |
| 1.5 | | | | 5x11 | 16 | | | 5x11 | 23 |
| 2.2 | | | | 5x11 | 23 | | | 5x11 | 28 |
| 3.3 | | | | 5x11 | 40 | | | 5x11 | 45 |
| 4.7 | | 5x11 | 45 | 5x11 | 45 | | | 5x11 | 50 |
| 6.8 | | 5x11 | 55 | 5x11 | 55 | 5x11 | 59 | 6.3x11 | 65 |
| 10 | | 5x11 | 70 | 5x11 | 70 | 6.3x11 | 75 | 8x12 | 90 |
| 15 | | 5x11 | 85 | 6.3x11 | 95 | 6.3x11 | 100 | 8x12 | 110 |
| 22 | | 6.3x11 | 110 | 6.3x11 | 110 | 8x12 | 115 | 10x13 | 136 |
| 33 | | 6.3x11 | 140 | 8x12 | 165 | 8x12 | 170 | 10x16 | 180 |
| 47 | | 8x12 | 190 | 8x12 | 190 | 10x13 | 200 | 10x20 | 220 |
| 68 | | 8x12 | 230 | 10x13 | 250 | 10x16 | 270 | 10x20 | 290 |
| 100 | | 10x13 | 300 | 10x16 | 320 | 10x20 | 330 | 13x21 | 370 |
| 150 | | 10x16 | 400 | 10x20 | 420 | 13x21 | 450 | 13x25 | 470 |
| 220 | | 10x20 | 440 | 13x21 | 490 | 13x21 | 550 | 16x26 | 580 |
| 330 | | 13x21 | 550 | 13x21 | 600 | 13x25 | 710 | 16x32 | 730 |
| 470 | | 13x25 | 680 | 13x25 | 750 | 16x26 | 850 | 18x35 | 910 |
| 680 | | 13x25 | 800 | 16x26 | 910 | 16x32 | 1050 | | |
| 1000 | | 16x26 | 1110 | 16x32 | 1140 | 18x35 | 1330 | | |
| 1500 | | 16x32 | 1390 | 18x40 | 1480 | | | | |
| 2200 | | 18x35 | 1580 | | | | | | |

※ 13mm may be replaced by 12.5mm upon customer's request.

RPC Series

- Low leakage current product.
- Suitable for prepositive amplifier of high-grade audio and oscillating return of TV set.
- RoHS Compliant & Halogen Free

Specifications

| Items | Characteristics | | | | | | | | |
|--|--|---|------|------|------|------|------|------|------|
| Capacitance Tolerance | ± 20% (120Hz, 20°C) | | | | | | | | |
| Operating Temperature Range | -40 ~ +105°C | | | | | | | | |
| Rated Voltage Range | 6.3 ~ 100VDC | | | | | | | | |
| Leakage Current | I ≤ 0.002CV or 0.4 (μA), which is greater. (After 2 minutes application of DC rated voltage, at 20°C) | | | | | | | | |
| Dissipation Factor | Measurement Frequency: 120Hz. Temperature: 20°C | | | | | | | | |
| | Rated Voltage (V) | 6.3 | 10 | 16 | 25 | 35 | 50 | 63 | 100 |
| | tan δ(Max) | 0.24 | 0.20 | 0.16 | 0.15 | 0.12 | 0.10 | 0.09 | 0.08 |
| When nominal capacitance over 1000μF, tan δ shall be added 0.02 to the listed value with increase of every 1000μF. | | | | | | | | | |
| Low Temperature Stability Impedance Ratio (Max) | Measurement Frequency: 120Hz. | | | | | | | | |
| | Rated Voltage(V) | 6.3 | 10 | 16 | 25 | 35 | 50 | 63 | 100 |
| | Z(-25°C)/Z(20°C) | 4 | 3 | 2 | 2 | 2 | 2 | 2 | 2 |
| Z(-40°C)/Z(20°C) | 8 | 6 | 6 | 4 | 4 | 3 | 3 | 3 | |
| Load Life | The following specifications shall be satisfied when the capacitors are restored to 20°C after subjected to DC voltage with the rated ripple current is applied for 1000 hours, at 105°C | | | | | | | | |
| | Capacitance Change | Within ± 25% of Initial Value | | | | | | | |
| | tan δ | 200% or less of Initial Specified Value | | | | | | | |
| | Leakage Current | Initial Specified Value or less | | | | | | | |
| Shelf Life | The following specifications shall be satisfied when the capacitors are restored to 20°C after exposing them for 1,000 hours 105°C without voltage applied. Before the measurement the capacitor shall be preconditioned by applying voltage according to them 4.1 of JIS C5101-4. | | | | | | | | |
| | Capacitance Change | Within ± 25% of Initial Value | | | | | | | |
| | tan δ | 200% or less of Initial Specified Value | | | | | | | |
| | Leakage Current | Initial Specified Value or less | | | | | | | |
| Standards | JIS C 5101-4 (IEC 60384) | | | | | | | | |

Frequency Coefficient of Permissible Ripple Current

| Capacitance (μF) | Frequency (Hz) | | | |
|------------------|----------------|------|------|------|
| | 50 | 120 | 1K | 10K |
| < 100 | 0.80 | 1.00 | 1.30 | 1.50 |
| 100 ~ 1000 | 0.80 | 1.00 | 1.15 | 1.20 |
| > 1000 | 0.80 | 1.00 | 1.10 | 1.15 |

The endurance of capacitors is reduced with internal heating produced by ripple current at the rate of halving the lifetime with every 5°C rise. When long life performance is required in actual use, the RMS ripple current has to be reduced.

RPC Series

Dimensions (mm)

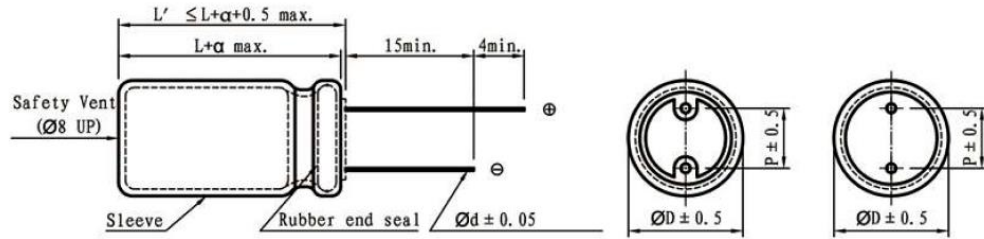

| | | | | | | | |
|----|-----|-----|-----|-----|-----|-----|-----|
| ØD | 5 | 6.3 | 8 | 10 | 13 | 16 | 18 |
| P | 2.0 | 2.5 | 3.5 | 5.0 | 5.0 | 7.5 | 7.5 |
| Ød | 0.5 | 0.5 | 0.5 | 0.6 | 0.6 | 0.8 | 0.8 |

| | |
|----------|--------------|
| α | (L < 16) 1.0 |
| | (L ≥ 16) 2.0 |

Standard Ratings

DxL(mm) ; R.C.(mA rms) at 105°C 120Hz.

| Cap (µF) | V | 6.3 | | 10 | | 16 | | 25 | |
|----------|------|-------|------|--------|------|--------|------|--------|------|
| | Item | D x L | R.C. | D x L | R.C. | D x L | R.C. | D x L | R.C. |
| 4.7 | | | | | | | | 5x11 | 45 |
| 6.8 | | | | | | | | 5x11 | 55 |
| 10 | | | | | | 5x11 | 55 | 5x11 | 70 |
| 15 | | | | | | 5x11 | 70 | 5x11 | 85 |
| 22 | | | | | | 5x11 | 85 | 5x11 | 100 |
| 33 | | | | | | 5x11 | 100 | 6.3x11 | 140 |
| 47 | | | | 5x11 | 100 | 6.3x11 | 140 | 6.3x11 | 170 |
| 68 | | | | 6.3x11 | 150 | 6.3x11 | 160 | 8x12 | 230 |
| 100 | | | | 6.3x11 | 180 | 8x12 | 230 | 8x12 | 280 |
| 150 | | | | 8x12 | 250 | 8x12 | 280 | 10x13 | 370 |
| 220 | | | | 8x12 | 310 | 10x13 | 370 | 10x16 | 400 |
| 330 | | | | 10x13 | 400 | 10x16 | 420 | 10x20 | 490 |
| 470 | | 10x13 | 385 | 10x16 | 530 | 10x16 | 550 | 10x20 | 650 |
| 680 | | 10x13 | 480 | 10x16 | 600 | 10x20 | 720 | 13x21 | 800 |
| 1000 | | 10x16 | 640 | 10x20 | 780 | 13x21 | 900 | 13x25 | 1000 |
| 1500 | | 10x20 | 900 | 13x25 | 1020 | 16x26 | 1150 | 16x32 | 1270 |
| 2200 | | 13x21 | 1050 | 13x25 | 1200 | 16x26 | 1300 | 16x36 | 1440 |
| 3300 | | 16x26 | 1300 | 16x32 | 1420 | 16x36 | 1550 | 18x40 | 1720 |
| 4700 | | 16x32 | 1500 | 16x36 | 1650 | 18x35 | 1820 | | |

※ 13mm may be replaced by 12.5mm upon customer's request.

RPC Series

Standard Ratings

DxL(mm) ; R.C.(mA rms) at 105°C 120Hz.

| Cap (µF) | V | 35 | | 50 | | 63 | | 100 | |
|----------|------|--------|------|--------|------|--------|------|--------|------|
| | Item | D x L | R.C. | D x L | R.C. | D x L | R.C. | D x L | R.C. |
| 0.1 | | | | 5x11 | 1.1 | | | 5x11 | 2.1 |
| 0.15 | | | | 5x11 | 1.6 | | | 5x11 | 3.2 |
| 0.22 | | | | 5x11 | 2.3 | | | 5x11 | 4.7 |
| 0.33 | | | | 5x11 | 3.5 | | | 5x11 | 7.0 |
| 0.47 | | | | 5x11 | 5.0 | | | 5x11 | 10.1 |
| 0.68 | | | | 5x11 | 7.3 | | | 5x11 | 14.5 |
| 1 | | | | 5x11 | 10.7 | | | 5x11 | 19 |
| 1.5 | | | | 5x11 | 16 | | | 5x11 | 23 |
| 2.2 | | | | 5x11 | 23 | | | 5x11 | 28 |
| 3.3 | | | | 5x11 | 40 | | | 5x11 | 45 |
| 4.7 | | 5x11 | 45 | 5x11 | 45 | | | 5x11 | 50 |
| 6.8 | | 5x11 | 55 | 5x11 | 55 | 5x11 | 59 | 6.3x11 | 65 |
| 10 | | 5x11 | 70 | 5x11 | 70 | 6.3x11 | 75 | 8x12 | 90 |
| 15 | | 5x11 | 85 | 6.3x11 | 95 | 6.3x11 | 100 | 8x12 | 110 |
| 22 | | 6.3x11 | 110 | 6.3x11 | 110 | 8x12 | 115 | 10x13 | 136 |
| 33 | | 6.3x11 | 140 | 8x12 | 165 | 8x12 | 170 | 10x16 | 180 |
| 47 | | 8x12 | 190 | 8x12 | 190 | 10x13 | 200 | 10x20 | 220 |
| 68 | | 8x12 | 230 | 10x13 | 250 | 10x16 | 270 | 10x20 | 290 |
| 100 | | 10x13 | 300 | 10x16 | 320 | 10x20 | 330 | 13x21 | 370 |
| 150 | | 10x16 | 400 | 10x20 | 420 | 13x21 | 450 | 13x25 | 470 |
| 220 | | 10x20 | 440 | 13x21 | 490 | 13x21 | 550 | 16x26 | 580 |
| 330 | | 13x21 | 550 | 13x21 | 600 | 13x25 | 710 | 16x32 | 730 |
| 470 | | 13x25 | 680 | 13x25 | 750 | 16x26 | 850 | 18x35 | 910 |
| 680 | | 13x25 | 800 | 16x26 | 910 | 16x32 | 1050 | | |
| 1000 | | 16x26 | 1110 | 16x32 | 1140 | 18x35 | 1330 | | |
| 1500 | | 16x32 | 1390 | 18x40 | 1480 | | | | |
| 2200 | | 18x35 | 1580 | | | | | | |

※ 13mm may be replaced by 12.5mm upon customer's request.

RPD Series

- Protective countermeasure against DC over-voltage, 105°C 2000hours.
- RoHS Compliant & Halogen Free

Specifications

| Items | Characteristics | |
|---|--|---|
| Capacitance Tolerance | ± 20% (120Hz, 20°C) | |
| Operating Temperature Range | -25 ~ +105°C | |
| Rated Voltage Range | 200VDC, 400VDC | |
| Leakage Current | $I \leq 0.04CV + 100$ (μA) (After 1 minute application of DC rated voltage, at 20 °C) | |
| Dissipation Factor | Measurement Frequency: 120Hz. Temperature: 20°C | |
| | Rated Voltage (V) | 200 400 |
| | tan δ(Max) | 0.15 0.15 |
| Low Temperature Stability Impedance Ratio (Max) | Measurement Frequency: 120Hz. | |
| | Rated Voltage(V) | 200 400 |
| | Z(-25°C)/Z(20°C) | 4 6 |
| Load Life | 2000 hours, with application of rated voltage at 105°C | |
| | Capacitance Change | Within ± 20% of Initial Value |
| | tan δ | 200% or less of the Initial Specified Value |
| | Leakage Current | Initial Specified Value or less |
| Shelf Life | The following specifications shall be satisfied when the capacitors are restored to 20°C after exposing them for 1,000 hours 105°C without voltage applied. Before the measurement the capacitor shall be preconditioned by applying voltage according to them 4.1 of JIS C5101-4. | |
| | Capacitance Change | Within ±20% of Initial Value |
| | tan δ | 200% or less of Initial Specified Value |
| | Leakage Current | Initial Specified Value or less |
| Standards | JIS C 5101-4 (IEC 60384) | |

DC over voltage test conditions

The vent will be Operated, and the capacitor shall become an open circuit without burning materials when the following excess DC voltage is applied.

TEST DC VOLTAGE

| Rated Voltage | Current Limit | Test DC voltage |
|---------------|---------------|-------------------|
| 200 Vdc | 4A | 300 Vdc / 375 Vdc |
| 400 Vdc | 2A | 500 Vdc / 600 Vdc |

TEST CIRCUIT

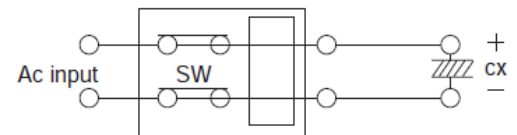

Frequency Coefficient of Permissible Ripple Current

| Rated Voltage (V) | Capacitance (μF) | Frequency (Hz) | | | | |
|-------------------|------------------|----------------|------|------|------|-------|
| | | 60 (50) | 120 | 150 | 1K | ≧ 10K |
| 200 | 22 ~ 470 | 0.85 | 1.00 | 1.30 | 1.50 | 1.85 |
| | 4.7 ~ 68 | 0.85 | 1.00 | 1.20 | 1.30 | 1.50 |
| 400 | 82 ~ 220 | 0.85 | 1.00 | 1.10 | 1.15 | 1.20 |

The endurance of capacitors is reduced with internal heating produced by ripple current at the rate of halving the lifetime with every 5°C rise. When long life performance is required in actual use, the RMS ripple current has to be reduced.

RPD Series

Dimensions (mm)

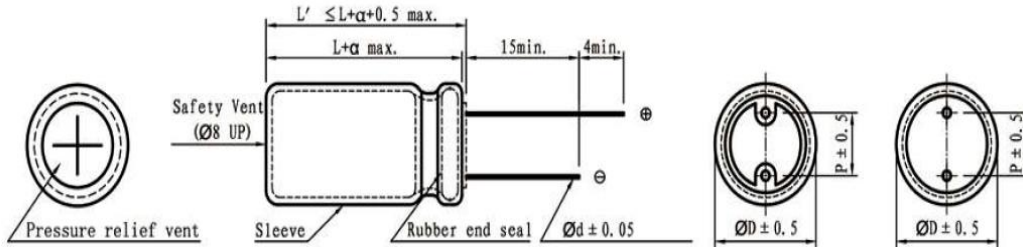

| | | | | | | |
|-----|-----|-----|-----|-----|-----|-----|
| Ø D | 10 | 13 | 16 | 18 | 20 | 22 |
| P | 5.0 | 5.0 | 7.5 | 7.5 | 10 | 10 |
| Ø d | 0.6 | 0.6 | 0.8 | 0.8 | 0.8 | 0.8 |

Standard Ratings

DxL(mm) ; R.C.(mA RMS) at 105°C 120Hz.

| V | Cap (µF) | D x L | R.C. |
|-----|----------|-------|-------|
| 200 | 22 | 10x20 | 120 |
| | 33 | 10x25 | 160 |
| | | 13x21 | 160 |
| | 47 | 10x30 | 195 |
| | | 13x21 | 195 |
| | 56 | 13x25 | 210 |
| | | 68 | 13x25 |
| | 16x22 | | 250 |
| | 82 | 13x32 | 285 |
| | | 16x22 | 285 |
| | | 16x26 | 305 |
| | | 13x35 | 335 |
| | 100 | 16x26 | 335 |
| | | 16x36 | 350 |
| | | 18x21 | 335 |
| | 120 | 16x26 | 450 |
| | | 16x32 | 500 |
| | | 18x25 | 500 |
| | | 16x32 | 560 |
| | 150 | 16x36 | 585 |
| | | 18x21 | 560 |
| | | 18x25 | 585 |
| | 180 | 16x36 | 600 |
| | | 16x40 | 645 |
| | | 18x32 | 645 |
| | 220 | 18x32 | 680 |
| | | 18x35 | 700 |
| | | 18x40 | 735 |
| 330 | 18x35 | 775 | |
| | 18x40 | 810 | |
| | 18x45 | 920 | |
| 390 | 18x40 | 850 | |
| | 22x40 | 920 | |
| 470 | 18x45 | 1120 | |
| | 22x40 | 1270 | |

RPD Series

Standard Ratings

DxL(mm) ; R.C.(mA RMS) at 105°C 120Hz.

| V | Cap (μF) | D x L | R.C. | |
|-------|----------|-------|-------|-----|
| 400 | 4.7 | 10x10 | 60 | |
| | | 10x13 | 63 | |
| | 10 | 10x16 | 87 | |
| | 15 | 10x20 | 105 | |
| | 18 | 10x25 | 115 | |
| | 22 | 13x25 | 13x25 | 135 |
| | | | 13x30 | 145 |
| | | | 16x22 | 145 |
| | | | 16x26 | 180 |
| | 33 | 13x25 | 13x25 | 175 |
| | | | 16x26 | 195 |
| | | | 18x21 | 225 |
| | | | 18x25 | 255 |
| | 47 | 13x32 | 13x32 | 370 |
| | | | 16x26 | 268 |
| | | | 16x32 | 275 |
| | | | 16x36 | 290 |
| | | | 18x21 | 275 |
| | | | 18x25 | 290 |
| | 56 | 18x32 | 18x32 | 310 |
| | | | 16x32 | 326 |
| | | | 16x36 | 338 |
| | | | 16x40 | 350 |
| | 68 | 18x32 | 18x32 | 320 |
| | | | 16x40 | 360 |
| | | | 18x25 | 350 |
| | | | 18x32 | 360 |
| | 82 | 18x35 | 18x35 | 380 |
| | | | 16x32 | 395 |
| | | | 18x25 | 395 |
| | | | 18x32 | 400 |
| | 100 | 18x40 | 18x40 | 420 |
| 18x28 | | | 450 | |
| 18x32 | | | 470 | |
| 18x35 | | | 490 | |
| 120 | 18x40 | 18x40 | 510 | |
| | | 18x32 | 515 | |
| | | 18x35 | 530 | |
| 150 | 18x40 | 18x40 | 550 | |
| | | 18x35 | 770 | |
| 180 | 18x40 | 790 | | |
| 180 | 22x35 | 800 | | |
| 220 | 22x40 | 1000 | | |

RPE Series

- Ideally Suited for first class audio equipment where qualitative Quantitative comfortableness is required.
- RoHS Compliance.

Specifications

| Items | Characteristics | | | | | | | | | | |
|---|--|---|------|------|------|------|------|------|------|------|------|
| Capacitance Tolerance | ± 20% (120Hz, 20°C) | | | | | | | | | | |
| Operating Temperature Range | -40~+105°C | | | | | | | | | | |
| Rated Voltage Range | 6.3~160VDC | | | | | | | | | | |
| Leakage Current | $I \leq 0.01CV$ or 3 (μA) which is greater. (After 2 minutes application of DC rated voltage, at 20 °C) | | | | | | | | | | |
| Dissipation Factor | Measurement Frequency: 120Hz. Temperature: 20°C | | | | | | | | | | |
| | Rated Voltage (V) | 6.3 | 10 | 16 | 25 | 35 | 50 | 63 | 80 | 100 | 200 |
| | tan δ(Max) | 0.24 | 0.20 | 0.16 | 0.15 | 0.12 | 0.10 | 0.09 | 0.09 | 0.08 | 0.15 |
| When nominal capacitance over 1000μF, tanδ shall be added 0.02 to the listed value with increase of every 1000μF. | | | | | | | | | | | |
| Low Temperature Stability | Measurement Frequency: 120Hz. | | | | | | | | | | |
| | Rated Voltage(V) | 6.3 | 10 | 16 | 25 | 35 | 50 | 63 | 80 | 100 | |
| Impedance Ratio (Max) | Z(-25°C)/Z(20°C) | 5 | 4 | 3 | 2 | 2 | 2 | 3 | 2 | 2 | |
| | Z(-40°C)/Z(20°C) | 12 | 10 | 8 | 6 | 4 | 3 | 4 | 3 | 3 | |
| Load Life | 2000hours, with application of rated voltage at 105°C | | | | | | | | | | |
| | Capacitance Change | Within ± 20% of Initial Value | | | | | | | | | |
| | tan δ | 200% or less of Initial Specified Value | | | | | | | | | |
| | Leakage Current | Initial Specified Value or less | | | | | | | | | |
| Shelf Life | The following specifications shall be satisfied when the capacitors are restored to 20°C after exposing them for 1,000 hours 85°C without voltage applied. Before the measurement, the capacitor shall be preconditioned by applying voltage according to them 4.1 of JIS C5101-4. | | | | | | | | | | |
| | Capacitance Change | Within ± 20% of Initial Value | | | | | | | | | |
| | tan δ | 200% or less of Initial Specified Value | | | | | | | | | |
| | Leakage Current | Initial Specified Value or less | | | | | | | | | |
| Standards | JIS C 5101-4 (IEC 60384) | | | | | | | | | | |

Frequency Coefficient of Permissible Ripple Current

| Rated Voltage (V) | Frequency (Hz) | | | | |
|-------------------|----------------|------|------|------|------|
| | 50 | 120 | 300 | 1K | 10K |
| 1~47 | 0.75 | 0.75 | 1.00 | 1.40 | 1.50 |
| 100~470 | 0.80 | 0.75 | 1.00 | 1.20 | 1.30 |
| 1000~10000 | 0.85 | 0.85 | 1.00 | 1.10 | 1.15 |

The endurance of capacitors is reduced with internal heating produced by ripple current at the rate of halving the lifetime with every 5°C rise. When long life performance is required in actual use, the RMS ripple current has to be reduced.

RPE Series

Dimensions (mm)

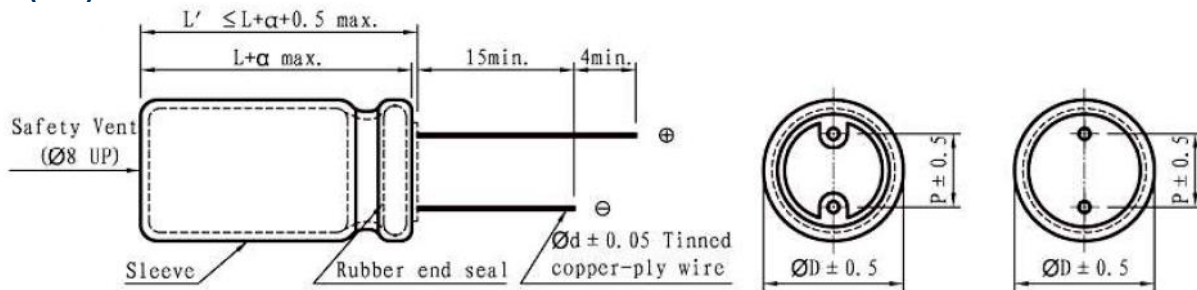

| | | | | | | | |
|-----|-----|-----|-----|------|------|-----|-----|
| Ø D | 5 | 6.3 | 8 | 10 | 12.5 | 16 | 18 |
| P | 2.0 | 2.5 | 3.5 | 5.0 | 5.0 | 7.5 | 7.5 |
| Ø d | 0.5 | 0.5 | 0.5 | 0.61 | 0.6 | 0.8 | 0.8 |

Standard Ratings

DxL(mm) ; R.C.(mA rms) at 105°C 120Hz.

| Cap (µF) | V | 6.3 | | 10 | | 16 | | 25 | | 35 | | 50 | |
|----------|-----------|-------|-----------|-------|-----------|--------|-----------|----------|-----------|----------|-----------|----------|------|
| | Item | D x L | R.C. | D x L | R.C. | D x L | R.C. | D x L | R.C. | D x L | R.C. | D x L | R.C. |
| 1 | | | | | | | | | | | | 5 x 11 | 9 |
| 2.2 | | | | | | | | | | | | 5 x 11 | 18 |
| 3.3 | | | | | | | | | | | | 5 x 11 | 22 |
| 4.7 | | | | | | | | | | | | 5 x 11 | 27 |
| 10 | | | | | | | | | | | | 5 x 11 | 39 |
| 22 | | | | | | | | 5 x 11 | 50 | 6.3 x 11 | 60 | 6.3 x 11 | 65 |
| 33 | | | | | | 5 x 11 | 57 | 6.3 x 11 | 70 | 6.3 x 11 | 75 | 8 x 12 | 93 |
| 47 | | | 5 x 11 | 60 | 6.3 x 11 | 74 | 6.3 x 11 | 85 | 8 x 12 | 101 | 8 x 12 | 111 | |
| 100 | | | 6.3 x 11 | 99 | 8 x 12 | 128 | 8 x 12 | 140 | 10 x 13 | 176 | 10 x 16 | 215 | |
| 220 | | | 8 x 12 | 170 | 10 x 13 | 226 | 10 x 16 | 260 | 10 x 20 | 320 | 12.5 x 20 | 390 | |
| 330 | | | 10 x 13 | 247 | 10 x 16 | 309 | 10 x 20 | 352 | 12.5 x 20 | 446 | 12.5 x 20 | 488 | |
| 470 | 10 x 13 | 270 | 10 x 13 | 330 | 12.5 x 20 | 406 | 12.5 x 20 | 476 | 12.5 x 25 | 590 | 16 x 25 | 650 | |
| 1000 | 10 x 20 | 485 | 12.5 x 20 | 601 | 16 x 25 | 723 | 16 x 25 | 854 | 16 x 25 | 1060 | 16 x 32 | 1143 | |
| 2200 | 12.5 x 25 | 867 | 16 x 25 | 1047 | 16 x 32 | 1290 | 16 x 35 | 1570 | 18 x 35 | 1840 | | | |
| 3300 | 16 x 25 | 1135 | 16 x 32 | 1520 | 16 x 35 | 1720 | 18 x 40 | 1794 | | | | | |
| 4700 | 16 x 32 | 1431 | 16 x 35 | 1840 | 18 x 40 | 2140 | | | | | | | |
| 6800 | 18 x 35 | 1810 | 18 x 40 | 2049 | | | | | | | | | |
| 10000 | 18 x 40 | 2100 | | | | | | | | | | | |

| Cap (µF) | V | 63 | | 80 | | 100 | |
|----------|------|-----------|------|-----------|------|-----------|------|
| | Item | D x L | R.C. | D x L | R.C. | D x L | R.C. |
| 1 | | | | | | 5 x 11 | 15 |
| 2.2 | | | | | | 5 x 11 | 22 |
| 3.3 | | | | | | 5 x 11 | 27 |
| 4.7 | | | | | | 5 x 11 | 36 |
| 10 | | 6.3 x 11 | 50 | 6.3 x 11 | 55 | 8 x 12 | 65 |
| 22 | | 8 x 12 | 85 | 8 x 12 | 100 | 10 x 13 | 110 |
| 33 | | 8 x 12 | 105 | 10 x 13 | 130 | 10 x 16 | 150 |
| 47 | | 10 x 13 | 140 | 10 x 16 | 170 | 10 x 16 | 190 |
| 100 | | 10 x 20 | 255 | 12.5 x 20 | 270 | 12.5 x 20 | 300 |
| 220 | | 12.5 x 20 | 420 | 12.5 x 25 | 490 | 16 x 25 | 549 |
| 330 | | 12.5 x 25 | 541 | 16 x 32 | 650 | 16 x 32 | 734 |
| 470 | | 16 x 25 | 840 | 16 x 35 | 920 | 18 x 35 | 980 |
| 1000 | | 18 x 35 | 1400 | | | | |

※13mm may be replaced by 12.5mm upon customer's request.

RSA Series

- 85°C 2000 hours, standard product.
- RoHS Compliant & Halogen Free

Specifications

| Items | Characteristics | | | | | | | | | | | |
|---|--|---|------|------|--------------|------|--|---------|--------------|---------|------|---------|
| Capacitance Tolerance | ± 20% (120Hz, 20°C) | | | | | | | | | | | |
| Operating Temperature Range | -40 ~ +85°C | | | | -40 ~ +85°C | | | | -25 ~ +85°C | | | |
| Rated Voltage Range | 6.3 ~ 100VDC | | | | 160 ~ 250VDC | | | | 350 ~ 500VDC | | | |
| Leakage Current | I ≤ 0.01CV or 3 (μA) which is greater. (After 2 minutes application of DC rated voltage, at 20 °C) | | | | | | I ≤ 0.03CV + 20 (μA) (After 3 minutes application of DC rated voltage, at 20 °C) | | | | | |
| Dissipation Factor | Measurement Frequency: 120Hz. Temperature: 20°C | | | | | | | | | | | |
| | Rated Voltage (V) | 6.3 | 10 | 16 | 25 | 35 | 50 | 63 | 100 | 160~250 | 330 | 350~500 |
| | tan δ(Max) | 0.24 | 0.20 | 0.16 | 0.15 | 0.12 | 0.10 | 0.09 | 0.08 | 0.20 | 0.25 | 0.25 |
| When nominal capacitance over 1000μF, tanδ shall be added 0.02 to the listed value with increase of every 1000μF. | | | | | | | | | | | | |
| Low Temperature Stability | Measurement Frequency: 120Hz. | | | | | | | | | | | |
| | Rated Voltage(V) | 6.3 | 10 | 16 | 25 | 35 | 50~100 | 160~250 | 350~400 | 450~500 | | |
| Impedance Ratio (Max) | Z(-25°C)/Z(20°C) | 5 | 4 | 3 | 2 | 2 | 2 | 3 | 6 | 8 | | |
| | Z(-40°C)/Z(20°C) | 12 | 10 | 8 | 6 | 4 | 3 | 4 | - | - | | |
| Load Life | 2000hours, with application of rated voltage at 85°C | | | | | | | | | | | |
| | Capacitance Change | Within ± 20% of Initial Value | | | | | | | | | | |
| | tan δ | 200% or less of Initial Specified Value | | | | | | | | | | |
| | Leakage Current | Initial Specified Value or less | | | | | | | | | | |
| Shelf Life | The following specifications shall be satisfied when the capacitors are restored to 20°C after exposing them for 1,000 hours 85°C without voltage applied. Before the measurement, the capacitor shall be preconditioned by applying voltage according to them 4.1 of JIS C5101-4. | | | | | | | | | | | |
| | Capacitance Change | Within ± 20% of Initial Value | | | | | | | | | | |
| | tan δ | 200% or less of Initial Specified Value | | | | | | | | | | |
| | Leakage Current | Initial Specified Value or less | | | | | | | | | | |
| Standards | JIS C 5101-4 (IEC 60384) | | | | | | | | | | | |

Frequency Coefficient of Permissible Ripple Current

| Rated Voltage (V) | Capacitance (μF) | Frequency (Hz) | | | |
|-------------------|------------------|----------------|------|------|-------|
| | | 50 | 120 | 1K | ≤ 20K |
| ≧ 100 | < 100 | 0.75 | 1.00 | 1.57 | 2.00 |
| | 100~470 | 0.80 | 1.00 | 1.34 | 1.50 |
| | > 470 | 0.85 | 1.00 | 1.10 | 1.15 |
| ≧ 160 | 0.1 ~ 220 | 0.80 | 1.00 | 1.40 | 1.60 |
| | 330 ~ 1000 | 0.90 | 1.00 | 1.13 | 1.15 |

The endurance of capacitors is reduced with internal heating produced by ripple current at the rate of halving the lifetime with every 5°C rise. When long life performance is required in actual use, the rms ripple current has to be reduced.

RSA Series

Dimensions (mm)

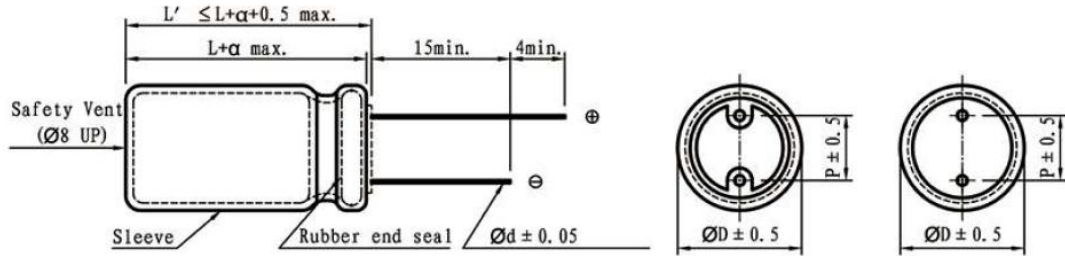

| | | | | | | | | | |
|----|-----|-----|-----|-----|-----|-----|-----|-----|------|
| ØD | 5 | 6.3 | 8 | 10 | 13 | 16 | 18 | 22 | 25 |
| P | 2.0 | 2.5 | 3.5 | 5.0 | 5.0 | 7.5 | 7.5 | 10 | 12.5 |
| Ød | 0.5 | 0.5 | 0.5 | 0.6 | 0.6 | 0.8 | 0.8 | 0.8 | 1.0 |

| | |
|----------|--------------|
| α | (L < 16) 1.0 |
| | (L ≥ 16) 2.0 |

Standard Ratings

DxL(mm) ; R.C.(mA rms) at 85°C 120Hz.

| Cap (µF) | V | 6.3 | | 10 | | 16 | | 25 | | 35 | | 50 | | 63 | | 100 | | |
|----------|---|-------|-------|-------|-------|-------|-------|-------|-------|-------|-------|-------|-------|-------|-------|-------|-------|------|
| | | Item | D x L | R.C. | D x L | R.C. | D x L | R.C. | D x L | R.C. | D x L | R.C. | D x L | R.C. | D x L | R.C. | D x L | R.C. |
| 22 | | | | | | | | | | | | | | | | | 8x12 | 151 |
| 33 | | | | | | | | | | | | | | | | | 8x9 | 180 |
| | | | | | | | | | | | | | | | | | 10x13 | 204 |
| 47 | | | | | | | | | | | | | | | | | 8x9 | 193 |
| | | | | | | | | | | | | | | | | | 8x12 | 218 |
| 68 | | | | | | | | | | 8x12 | 206 | 8x12 | 249 | 8x12 | 278 | 10x20 | 315 | |
| 100 | | | | | | | | | | 8x12 | 278 | 8x9 | 275 | 8x14 | 363 | 10x20 | 459 | |
| | | | | | | | | | | | | 8x12 | 303 | | | | | |
| 220 | | | | | | | | 8x12 | 387 | 8x9 | 362 | 10x16 | 532 | 10x16 | 593 | 13x25 | 726 | |
| | | | | | | | | | | 10x13 | 448 | | | | | | | |
| 330 | | | | | | 8x12 | 436 | 8x9 | 442 | 10x16 | 593 | 10x20 | 702 | 10x20 | 823 | 16x26 | 907 | |
| | | | | | | | | 8x14 | 508 | | | | | | | | | |
| 470 | | 8x12 | 460 | 8x12 | 484 | 8x9 | 508 | 10x16 | 653 | 10x16 | 774 | 13x13 | 808 | 13x21 | 1065 | 16x32 | 1113 | |
| | | | | | | 8x12 | 569 | | | | | 13x21 | 920 | | | | | |
| 1000 | | 8x9 | 617 | 10x13 | 762 | 10x16 | 956 | 10x20 | 1150 | 13x21 | 1331 | 13x25 | 1634 | 16x26 | 1755 | 18x40 | 1573 | |
| | | 10x13 | 702 | | | | | | | | | | | | | | | |
| 1500 | | 10x16 | 788 | 10x20 | 823 | 10x20 | 1101 | 13x21 | 1367 | 13x25 | 1597 | 16x32 | 1925 | 18x32 | 2310 | 22x40 | 2145 | |
| 2200 | | 10x16 | 1150 | 10x20 | 1331 | 13x21 | 1634 | 13x25 | 1876 | 16x26 | 2178 | 16x36 | 2541 | 18x35 | 2783 | 25x50 | 2432 | |
| 3300 | | 10x20 | 1513 | 13x21 | 1694 | 13x25 | 2057 | 16x26 | 2118 | 16x32 | 2686 | 18x35 | 3037 | 22x40 | 3267 | | | |
| | | 13x13 | 1392 | | | | | | | | | | | | | | | |
| 4700 | | 13x21 | 1815 | 13x25 | 2178 | 16x26 | 2420 | 16x32 | 2614 | 18x35 | 3110 | 22x40 | 3630 | 22x50 | 4114 | | | |
| 6800 | | 13x25 | 2299 | 16x26 | 2481 | 16x32 | 2783 | 18x35 | 3207 | 22x40 | 3884 | 22x50 | 4235 | 25x50 | 4719 | | | |
| 10000 | | 16x26 | 2481 | 16x36 | 3025 | 18x35 | 3485 | 22x40 | 4380 | 22x50 | 4719 | 25x50 | 4840 | | | | | |
| 15000 | | 16x36 | 3243 | 18x35 | 3775 | 22x40 | 4659 | 22x50 | 5082 | 25x50 | 5203 | | | | | | | |
| 22000 | | 18x40 | 3896 | 22x40 | 4489 | 22x50 | 5336 | 25x50 | 5445 | | | | | | | | | |
| 33000 | | 22x50 | 4719 | 22x50 | 5445 | 25x50 | 5808 | | | | | | | | | | | |

※13mm may be replaced by 12.5mm upon customer's request.

RSA Series

Standard Ratings

DxL(mm) ; R.C.(mA rms) at 85°C 120Hz.

| Cap (μF) | V | 160 | | 200 | | 250 | | 350 | |
|----------|------|-------|------|-------|------|-------|------|-------|------|
| | Item | D x L | R.C. | D x L | R.C. | D x L | R.C. | D x L | R.C. |
| 1.0 | | | | | | | | 8x12 | 28 |
| 2.2 | | | | | | 8x12 | 36 | 8x12 | 37 |
| 3.3 | | 8x12 | 42 | 8x12 | 50 | 8x12 | 55 | 10x13 | 56 |
| 4.7 | | 8x12 | 56 | 8x12 | 62 | 10x13 | 67 | 10x16 | 70 |
| 10 | | 10x13 | 97 | 10x16 | 105 | 10x16 | 110 | 10x20 | 120 |
| 22 | | 10x16 | 157 | 10x20 | 165 | 13x13 | 169 | 13x13 | 169 |
| | | | | | | 13x21 | 195 | 13x21 | 210 |
| 33 | | 10x20 | 230 | 13x13 | 212 | 13x21 | 245 | 16x26 | 280 |
| | | | | 13x21 | 238 | | | | |
| 47 | | 13x13 | 254 | 13x21 | 310 | 13x21 | 320 | 16x36 | 380 |
| | | 13x21 | 290 | | | | | | |
| 100 | | 16x26 | 520 | 16x26 | 550 | 16x32 | 570 | 18x40 | 600 |
| 220 | | 16x36 | 860 | 22x30 | 980 | 22x30 | 1070 | 22x50 | 1210 |
| 330 | | 18x40 | 1210 | 22x35 | 1280 | 22x35 | 1320 | | |
| 470 | | 22x40 | 1320 | 22x50 | 1360 | 25x50 | 1500 | | |
| 1000 | | 22x50 | 1720 | | | | | | |

| Cap (μF) | V | 400 | | 450 | | 500 | |
|----------|------|-------|------|-------|------|-------|------|
| | Item | D x L | R.C. | D x L | R.C. | D x L | R.C. |
| 1.0 | | 8x12 | 23 | 8x12 | 25 | | |
| 2.2 | | 10x13 | 35 | 10x13 | 36 | 10x13 | 32 |
| 3.3 | | 10x13 | 45 | 10x16 | 50 | 10x16 | 45 |
| 4.7 | | 10x16 | 55 | 10x20 | 62 | 10x20 | 55 |
| 10 | | 13x21 | 85 | 13x21 | 93 | 13x21 | 65 |
| 22 | | 16x26 | 160 | 16x26 | 172 | 16x26 | 135 |
| 33 | | 16x32 | 195 | 16x36 | 210 | 16x36 | 155 |
| 47 | | 16x36 | 275 | 18x40 | 285 | 18x40 | 235 |
| 100 | | 22x35 | 500 | 22x40 | 520 | 22x40 | 450 |
| 220 | | 25x50 | 970 | | | | |

※13mm may be replaced by 12.5mm upon customer's request.

RSB Series

- 105°C 2000hours, standard product
- RoHS Compliant & Halogen Free

SPECIFICATIONS

| Items | Characteristics | | | | | | | | | | | | | |
|--|---|---|------|------|--------------|------|--|---------|--------------|---------|------|---------|---------|------|
| Capacitance Tolerance | ± 20% (120Hz, 20°C) | | | | | | | | | | | | | |
| Operating Temperature Range | -40 ~ +105°C | | | | -40 ~ +105°C | | | | -25 ~ +105°C | | | | | |
| Rated Voltage Range | 6.3 ~ 100VDC | | | | 160 ~ 250VDC | | | | 350 ~ 500VDC | | | | | |
| Leakage Current | I ≤ 0.01CV or 3 (μA) which is greater. (After 2 minutes application of DC rated voltage, at 20 °C) | | | | | | I ≤ 0.03CV +20 (μA) (After 3 minutes application of DC rated voltage, at 20 °C) | | | | | | | |
| Dissipation Factor | Measurement Frequency: 120Hz. Temperature: 20°C | | | | | | | | | | | | | |
| | Rated Voltage(V) | 6.3 | 10 | 16 | 25 | 35 | 50 | 63 | 80 | 100 | 130 | 160~250 | 350~500 | 600 |
| | tan δ(Max) | 0.24 | 0.20 | 0.16 | 0.15 | 0.12 | 0.10 | 0.09 | 0.08 | 0.08 | 0.08 | 0.20 | 0.25 | 0.25 |
| When nominal capacitance over 1000μF, tanδ shall be added 0.02 to the listed value with increase of every 1000μF . | | | | | | | | | | | | | | |
| Low Temperature Stability | Measurement Frequency: 120Hz. | | | | | | | | | | | | | |
| Impedance Ratio(Max) | Rated Voltage(V) | 6.3 | 10 | 16 | 25 | 35 | 50~100 | 160~250 | 350~400 | 450~500 | | | | |
| | Z(-25°C)/Z(20°C) | 5 | 4 | 3 | 2 | 2 | 2 | 3 | 6 | 15 | | | | |
| | Z(-40°C)/Z(20°C) | 10 | 8 | 6 | 4 | 3 | 3 | 4 | - | - | | | | |
| Load Life | 2000hours, with application of rated voltage at 105°C | | | | | | | | | | | | | |
| | Capacitance Change | Within ± 20% of Initial Value | | | | | | | | | | | | |
| | tan δ | 200% or less of Initial Specified Value | | | | | | | | | | | | |
| | Leakage Current | Initial Specified Value or less | | | | | | | | | | | | |
| Shelf Life | The following specifications shall be satisfied when the capacitors are restored to 20°C after exposing them for 1,000 hours 105°C without voltage applied. Before the measurement, the capacitor shall be preconditioned by applying voltage according to them 4.1 of JIS C5101-4. | | | | | | | | | | | | | |
| | Capacitance Change | Within ± 20% of Initial Value | | | | | | | | | | | | |
| | tan δ | 200% or less of Initial Specified Value | | | | | | | | | | | | |
| | Leakage Current | Initial Specified Value or less | | | | | | | | | | | | |
| Standards | JIS C 5101-4 (IEC 60384) | | | | | | | | | | | | | |

Frequency Coefficient of Permissible Ripple Current

| Rated Voltage (V) | Capacitance (μF) | Frequency (Hz) | | | |
|-------------------|------------------|----------------|------|------|------|
| | | 50 | 120 | 1K | ≥20K |
| ≤ 100 | < 100 | 0.75 | 1.00 | 1.40 | 1.50 |
| | 100 ~ 470 | 0.75 | 1.00 | 1.20 | 1.30 |
| | > 470 | 0.85 | 1.00 | 1.10 | 1.15 |
| ≥ 160 | 0.47 ~ 470 | 0.75 | 1.00 | 1.10 | 1.20 |

The endurance of capacitors is reduced with internal heating produced by ripple current at the rate of halving the lifetime with every 5°C rise. When long life performance is required in actual use, the rms ripple current has to be reduced.

RSB Series

DIMENSIONS (mm)

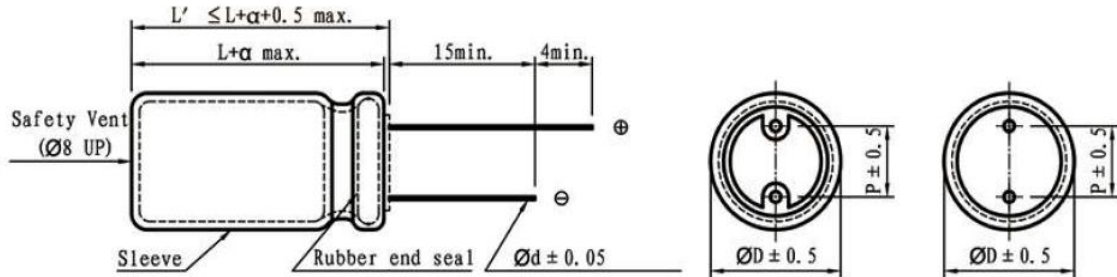

| | | | | | | | | | | |
|----|-----|-----|-----|-----|-----|------|-----|-----|-----|------|
| ØD | 5 | 6.3 | 8 | 10 | 13 | 14.5 | 16 | 18 | 22 | 25 |
| P | 2.0 | 2.5 | 3.5 | 5.0 | 5.0 | 7.5 | 7.5 | 7.5 | 10 | 12.5 |
| Ød | 0.5 | 0.5 | 0.5 | 0.6 | 0.6 | 0.8 | 0.8 | 0.8 | 0.8 | 1.0 |

| | |
|----------|--------------|
| α | (L < 16) 1.0 |
| | (L ≥ 16) 2.0 |

STANDARD RATINGS

DxL (mm); R.C. (mA rms) at 105°C 120 Hz.

| Cap (µF) | V | 6.3 | | 10 | | 16 | | 25 | | 35 | | 50 | | 63 | | 100 | |
|----------|---|--------|-------|--------|-------|--------|-------|---------------|------------|--------|-------|--------|-------|--------|-------|--------|-------|
| | | Item | D x L | R.C. | D x L | R.C. | D x L | R.C. | D x L | R.C. | D x L | R.C. | D x L | R.C. | D x L | R.C. | D x L |
| 0.1-0.47 | | | | | | | | | | | | 5x11 | 11 | 5x11 | 12 | 5x11 | 17 |
| 1 | | | | | | | | | | | | 5x11 | 15 | 5x11 | 17 | 5x11 | 20 |
| 2.2 | | | | | | | | | | | | 5x11 | 24 | 5x11 | 25 | 5x11 | 30 |
| 3.3 | | | | | | | | | | | | 5x11 | 30 | 5x11 | 31 | 5x11 | 36 |
| 4.7 | | | | | | | | 5x11 | 30 | 5x11 | 31 | 5x11 | 36 | 5x11 | 37 | 5x11 | 44 |
| 6.8 | | | | | | | | 5x11 | 35 | 5x11 | 37 | 5x11 | 46 | 5x11 | 51 | 5x11 | 45 |
| 10 | | | | | | 5x11 | 42 | 5x11 | 43 | 5x11 | 47 | 5x11 | 54 | 5x11 | 58 | 6.3x11 | 75 |
| 22 | | 5x11 | 54 | 5x11 | 59 | 5x11 | 63 | 5x11 | 65 | 5x11 | 75 | 5x11 | 83 | 6.3x11 | 109 | 8x12 | 112 |
| 33 | | 5x11 | 66 | 5x11 | 77 | 5x11 | 79 | 5x11 | 83 | 5x11 | 91 | 6.3x11 | 107 | 8x12 | 121 | 8x12 | 133 |
| 47 | | 5x11 | 78 | 5x11 | 87 | 5x11 | 94 | 5x11 | 97 | 6.3x11 | 116 | 6.3x11 | 145 | 8x12 | 163 | 10x13 | 170 |
| 56 | | 5x11 | 90 | 5x11 | 100 | 5x11 | 105 | 5x11 | 109 | 6.3x11 | 127 | 6.3x11 | 151 | 8x12 | 172 | 10x16 | 187 |
| 68 | | 5x11 | 102 | 5x11 | 119 | 5x11 | 145 | 5x11 | 151 | 6.3x11 | 169 | 6.3x11 | 196 | 8x12 | 206 | 10x16 | 238 |
| 100 | | 5x11 | 111 | 5x11 | 139 | 6.3x11 | 151 | 6.3x11 | 163 | 8x12 | 194 | 8x14 | 242 | 10x13 | 254 | 10x20 | 315 |
| 220 | | 5x11 | 175 | 6.3x11 | 212 | 8x12 | 237 | 8x12 | 290 | 10x13 | 332 | 10x16 | 363 | 10x20 | 436 | 13x25 | 581 |
| 330 | | 6.3x11 | 233 | 6.3x11 | 272 | 8x12 | 321 | 10x13 | 369 | 10x16 | 484 | 10x20 | 514 | 13x21 | 666 | 16x26 | 714 |
| 470 | | 6.3x11 | 266 | 8x12 | 299 | 8x14 | 381 | 8x16 10x16 | 436 460 | 10x20 | 581 | 13x21 | 762 | 13x25 | 847 | 16x32 | 968 |
| 560 | | 8x12 | 272 | 8x12 | 306 | 8x14 | 387 | 10x16 | 448 | 10x20 | 629 | 13x21 | 774 | 13x25 | 871 | 16x36 | 1012 |
| 680 | | 8x12 | 278 | 8x12 | 319 | 8x16 | 424 | 10x20 | 581 | 13x21 | 702 | 13x25 | 799 | 16x26 | 1004 | 18x32 | 1210 |
| 1000 | | 8x14 | 484 | 10x13 | 586 | 10x16 | 617 | 10x20 | 750 | 13x21 | 908 | 13x25 | 1089 | 16x32 | 1210 | 18x35 | 1573 |
| 1500 | | 8x20 | 545 | 10x20 | 592 | 10x20 | 641 | 13x21 | 787 | 13x25 | 1041 | 16x32 | 1452 | 18x32 | 1718 | | |
| 2200 | | 10x20 | 774 | 10x20 | 918 | 13x21 | 1004 | 13x25 | 1132 | 16x26 | 1343 | 16x36 | 1609 | 18x35 | 1997 | | |
| 3300 | | 10x20 | 908 | 13x21 | 1091 | 13x25 | 1222 | 16x26 | 1428 | 16x36 | 1730 | 18x35 | 1997 | 22x40 | 2347 | | |
| 4700 | | 13x21 | 1162 | 13x25 | 1306 | 16x26 | 1464 | 16x32 | 1718 | 18x35 | 2057 | 22x40 | 2541 | 22x50 | 2965 | | |
| 6800 | | 13x25 | 1385 | 16x26 | 1770 | 16x36 | 1863 | 18x35 | 2202 | 22x40 | 2602 | 22x50 | 3025 | | | | |
| 10000 | | 16x26 | 1730 | 16x36 | 2236 | 18x35 | 2335 | 22x40 | 2589 | 22x50 | 3207 | | | | | | |
| 15000 | | 16x36 | 2214 | 18x35 | 2808 | 22x40 | 2928 | 22x50 | 3328 | | | | | | | | |
| 22000 | | 18x40 | 2771 | 22x40 | 3514 | 22x50 | 3630 | | | | | | | | | | |

RSB Series

STANDARD RATINGS

DxL (mm); R.C. (mA rms) at 105° 120Hz.

| Cap (μF) | V | 160 | | 200 | | 250 | | 350 | | 400 | | 450 | | 500 | |
|-------------|------|--------|------|--------|------|-------|------|-------|------|-------|------|-------|------|-------|------|
| | Item | D x L | R.C. | D x L | R.C. | D x L | R.C. | D x L | R.C. | D x L | R.C. | D x L | R.C. | D x L | R.C. |
| 2.2 | | 6.3x11 | 35 | 6.3x11 | 35 | 8x12 | 72 | 8x12 | 56 | 10x13 | 54 | 10x16 | 75 | | |
| 3.3 | | 8x12 | 72 | 8x12 | 72 | 8x12 | 78 | 10x13 | 85 | 10x13 | 69 | 10x16 | 102 | 10x20 | 42 |
| 4.7 | | 8x12 | 75 | 8x12 | 75 | 10x13 | 110 | 10x13 | 90 | 10x16 | 120 | 10x20 | 130 | 10x20 | 56 |
| 6.8 | | 8x12 | 78 | 8x12 | 78 | 10x13 | 120 | 10x13 | 95 | 10x16 | 125 | 13x21 | 155 | 13x21 | 105 |
| 10 | | 10x13 | 92 | 10x16 | 145 | 10x16 | 145 | 10x20 | 150 | 10x20 | 145 | 13x21 | 165 | 13x21 | 110 |
| 22 | | 10x16 | 145 | 10x20 | 210 | 13x21 | 245 | 13x25 | 225 | 13x25 | 252 | 16x26 | 360 | 16x26 | 250 |
| 33 | | 10x20 | 210 | 13x21 | 245 | 13x21 | 255 | 13x25 | 245 | 16x26 | 380 | 16x26 | 380 | 16x32 | 280 |
| 47 | | 13x21 | 245 | 13x25 | 330 | 13x25 | 350 | 16x26 | 405 | 16x26 | 395 | 16x32 | 450 | 18x35 | 320 |
| 68 | | 13x21 | 255 | 13x25 | 340 | 16x26 | 540 | 16x32 | 450 | 16x32 | 475 | 18x32 | 585 | 18x45 | 360 |
| 82 | | 13x25 | 350 | 13x25 | 350 | 16x26 | 550 | 16x32 | 480 | 18x26 | 480 | 18x35 | 650 | | |
| 100 | | 16x26 | 530 | 16x26 | 540 | 16x32 | 630 | 18x32 | 580 | 18x32 | 580 | 18x40 | 720 | | |
| 120 | | 16x26 | 540 | 16x26 | 550 | 16x32 | 650 | 18x35 | 650 | 18x35 | 650 | 18x40 | 750 | | |
| 150 | | 16x26 | 550 | 16x32 | 650 | 18x32 | 730 | 18x40 | 750 | 18x40 | 720 | 22x45 | 785 | | |
| 220 | | 16x36 | 720 | 18x32 | 750 | 22x35 | 950 | | | | | | | | |
| 330 | | 18x35 | 810 | 22x35 | 860 | | | | | | | | | | |
| 470 | | 18x40 | 1050 | 22x40 | 1100 | | | | | | | | | | |

※ 13mm may be replaced by 12.5mm upon customer's request.

RSB Series

SLIM TYPE

- 105°C high-temperature and high voltage 400~500V, life 2000hrs.
- Specially Size, 8~16mm diameter.
- For LCD-TV and LCD-Monitor power.
- RoHS Compliant.

STANDARD RATINGS

DxL (mm); R.C. (mA rms) at 105°C 120Hz.

| Ca p (μ F) | V Item | 400 | | 450 | | 500 | |
|-----------------------|-----------|---------|------|---------|------|---------|------|
| | | D x L | R.C. | D x L | R.C. | D x L | R.C. |
| 22 | | 8x50 | 158 | 8x50 | 168 | 13x40 | 158 |
| | | 10x30 | 150 | 10x35 | 153 | | |
| 33 | | 8x61 | 210 | 8x61 | 218 | 13x45 | 162 |
| | | 10x40 | 192 | 10x45 | 198 | | |
| 39 | | 8x61 | 258 | 8x61 | 287 | 14.5x45 | 160 |
| | | 10x45 | 235 | 10x50 | 250 | | |
| | | 13x35 | 250 | 13x40 | 265 | | |
| 47 | | 10x50 | 285 | 10x50 | 335 | 14.5x45 | 163 |
| | | 13x40 | 282 | 13x45 | 305 | 16x50 | 175 |
| | | 14.5x30 | 278 | 14.5x30 | 290 | | |
| 53 | | 10x50 | 305 | 10x50 | 400 | 16x50 | 178 |
| 68 | | 13x45 | 340 | 14.5x40 | 460 | | |
| | | 14.5x30 | 330 | 16x35 | 490 | | |
| 82 | | 13x50 | 365 | 14.5x50 | 460 | | |
| | | 14.5x40 | 385 | 16x40 | 490 | | |
| 100 | | 14.5x45 | 468 | 14.5x50 | 620 | | |
| | | | | 16x50 | 640 | | |
| 120 | | 14.5x50 | 550 | 16x50 | 650 | | |

※ 13mm may be replaced by 12.5mm upon customer's request.

RSC Series

- 105°C high temperature resistance
- High ripple current
- RoHS Compliant & Halogen Free

Specifications

| Items | Characteristics | | | |
|-----------------------------|---|---|--------------|---------|
| Capacitance Tolerance | ± 20% (120Hz, 20°C) | | | |
| Operating Temperature Range | -40 ~ +105°C | | -25 ~ +105°C | |
| Rated Voltage Range | 160 ~ 400VDC | | 450VDC | |
| Leakage Current | I ≤ 0.03CV +20 (μA) (After 3 minutes application of DC rated voltage) | | | |
| Dissipation Factor | Measurement Frequency: 120Hz. Temperature: 20°C | | | |
| | Rated Voltage (V) | 160~250 | | 400~450 |
| | tan δ(Max) | 0.15 | | 0.20 |
| Low Temperature Stability | Measurement Frequency: 120Hz. | | | |
| | Rated Voltage(V) | 160~250 | 400 | 450 |
| Impedance Ratio (Max) | Z(-25°C)/Z(20°C) | 3 | 5 | 6 |
| | Z(-40°C)/Z(20°C) | 6 | 6 | - |
| Load Life | The following specifications shall be satisfied when the capacitors are restored to 20°C after subjected to DC voltage with the rated ripple current is applied for 2,000 hours at 105°C | | | |
| | Capacitance Change | Within ± 20% of Initial Value | | |
| | tan δ | 200% or less of Initial Specified Value | | |
| | Leakage Current | Initial Specified Value or less | | |
| Shelf Life | The following specifications shall be satisfied when the capacitors are restored to 20°C after exposing them for 1,000 hours 105°C without voltage applied. Before the measurement, the capacitor shall be preconditioned by applying voltage according to them 4.1 of JIS C5101-4. | | | |
| | Capacitance Change | Within ± 20% of Initial Value | | |
| | tan δ | 200% or less of Initial Specified Value | | |
| | Leakage Current | Initial Specified Value or less | | |
| Standards | JIS C 5101-4 (IEC 60384) | | | |

Frequency Coefficient of Permissible Ripple Current

| Capacitance (μF) | Frequency (Hz) | | | |
|------------------|----------------|------|------|------|
| | 120 | 1K | 10K | 100K |
| 22~82 | 1.00 | 1.25 | 1.50 | 1.75 |
| 100~470 | 1.00 | 1.15 | 1.30 | 1.40 |

The endurance of capacitors is reduced with internal heating produced by ripple current at the rate of halving the lifetime with every 5°C rise. When long life performance is required in actual use, the rms ripple current has to be reduced.

Aluminum Electrolytic Capacitors

RSC Series

Dimensions (mm)

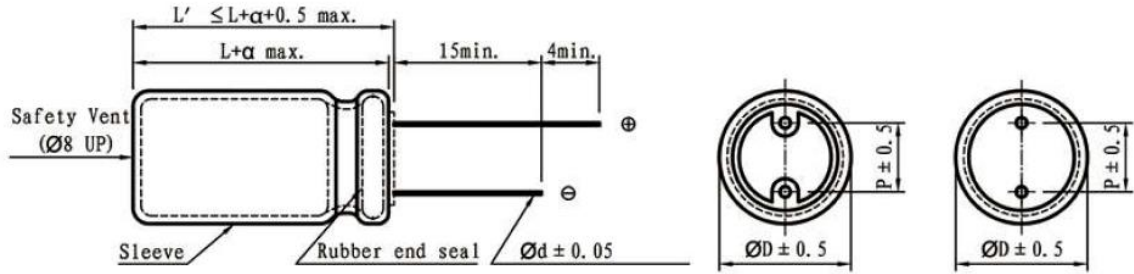

| | | | | | | |
|-------------|-----|-----|------|-----|-----|-----|
| ØD | 10 | 13 | 14.5 | 16 | 18 | 20 |
| P | 5.0 | 5.0 | 7.5 | 7.5 | 7.5 | 10 |
| Ød | 0.6 | 0.6 | 0.8 | 0.8 | 0.8 | 0.8 |

Standard Ratings

DxL(mm) ; R.C.(mA rms) at 105°C 120Hz.

| Ca P (μF) | V | 160 | | 200 | | 250 | | 400 | | 450 | |
|------------------------------|-------|-------|------|---------|------|-------|-------|---------|------|---------|------|
| | Item | D x L | R.C. | D x L | R.C. | D x L | R.C. | D x L | R.C. | D x L | R.C. |
| 22 | | | | | | | | 10x30 | 260 | 10x35 | 280 |
| 33 | | | | | | | | 10x40 | 360 | 13x30 | 375 |
| 39 | | | | | | | | 10x45 | 405 | 13x35 | 415 |
| 47 | | | | | | | | 13x35 | 443 | 13x40 | 465 |
| 56 | | | | | | | | 13x40 | 510 | 14.5x30 | 465 |
| | | | | | | | 16x30 | | | 520 | |
| 68 | 10x25 | 375 | | 10x30 | 485 | 13x25 | 530 | 13x45 | 580 | 14.5x40 | 600 |
| | | | | | | | | 14.5x30 | 580 | 16x35 | 600 |
| 82 | 10x30 | 485 | | 10x35 | 528 | 13x30 | 595 | 14.5x40 | 635 | 16x40 | 650 |
| | | | | | | | | | | 18x32 | 650 |
| 100 | 10x35 | 528 | | 10x40 | 615 | 16x25 | 650 | 14.5x45 | 690 | 18x36 | 700 |
| | | | | | | | | 18x32 | 690 | | |
| 120 | 10x40 | 615 | | 10x45 | 710 | 16x32 | 715 | 16x40 | 810 | 18x40 | 820 |
| | | | | | | | | 18x36 | 810 | | |
| 150 | 10x45 | 710 | | 13x35 | 780 | 16x35 | 860 | 18x40 | 940 | 18x45 | 990 |
| | | | | | | | | | | 20x40 | 1000 |
| 220 | 13x40 | 880 | | 13x45 | 995 | 18x36 | 1120 | | | | |
| | | | | 14.5x35 | 995 | | | | | | |
| 270 | 13x45 | 995 | | 16x35 | 1150 | 18x40 | 1200 | | | | |
| 330 | 16x35 | 1150 | | 16x40 | 1320 | | | | | | |
| | | | | 18x32 | 1320 | | | | | | |
| 470 | 18x40 | 1270 | | 18x45 | 1660 | | | | | | |

※ 13mm may be replaced by 12.5mm upon customer's request.

Aluminum Electrolytic Capacitors

RSD Series

- High-temperature resistance, high ripple current.
- 105°C for general purposes, 3000 hours standard product.
- RoHS Compliance

Specifications

| Items | Characteristics | | | | | | | | | | | | | |
|--|---|---|------|------|------|------|--------|--|---------|------|--------------|---------|---------|------|
| Capacitance Tolerance | ± 20% (120Hz, 20°C) | | | | | | | | | | | | | |
| Operating Temperature Range | -40 ~ +105°C | | | | | | | -40~+105°C | | | -25 ~ +105°C | | | |
| Rated Voltage Range | 6.3 ~ 100VDC | | | | | | | 160 ~ 250VDC | | | 350~450VDC | | | |
| Leakage Current | I ≤ 0.01CV or 3 (μA) which is greater. (After 2 minutes application of DC rated voltage, at 20°C) | | | | | | | I ≤ 0.03CV + 20(μA) (After 3 minutes application of DC rated voltage, at 20°C) | | | | | | |
| Dissipation Factor (tan δ) | Measurement Frequency: 120Hz. Temperature: 20°C | | | | | | | | | | | | | |
| | Rated Voltage (V) | 6.3 | 10 | 16 | 25 | 35 | 50 | 63 | 80 | 100 | 120 | 160~250 | 350~450 | 500 |
| | tan δ(Max) | 0.24 | 0.20 | 0.16 | 0.15 | 0.12 | 0.10 | 0.09 | 0.08 | 0.08 | 0.08 | 0.20 | 0.25 | 0.25 |
| When nominal capacitance over 1000μF, tanδ shall be added 0.02 to the listed value with increase of every 1000μF | | | | | | | | | | | | | | |
| Low Temperature Stability | Measurement Frequency: 120Hz. | | | | | | | | | | | | | |
| | Rated Voltage(V) | 6.3 | 10 | 16 | 25 | 35 | 50~100 | 160~250 | 350~400 | 450 | | | | |
| | Z(-25°C)/Z(20°C) | 5 | 4 | 3 | 2 | 2 | 2 | 3 | 6 | 15 | | | | |
| Impedance Ratio (Max) | Z(-40°C)/Z(20°C) | 10 | 8 | 6 | 4 | 3 | 3 | 4 | - | - | | | | |
| | | | | | | | | | | | | | | |
| Load Life | 3,000 hours, with application of rated voltage at 105°C | | | | | | | | | | | | | |
| | Capacitance Change | Within ± 20% of Initial Value | | | | | | | | | | | | |
| | tan δ | 200% or less of Initial Specified Value | | | | | | | | | | | | |
| | Leakage Current | Initial Specified Value or less | | | | | | | | | | | | |
| Shelf Life | The following specifications shall be satisfied when the capacitors are restored to 20°C after exposing them for 1,000 hours 105°C without voltage applied. Before the measurement, the capacitor shall be preconditioned by applying voltage according to them 4.1 of JIS C5101-4. | | | | | | | | | | | | | |
| | Capacitance Change | Within ± 20% of Initial Value | | | | | | | | | | | | |
| | tan δ | 200% or less of Initial Specified Value | | | | | | | | | | | | |
| | Leakage Current | Initial Specified Value or less | | | | | | | | | | | | |
| Standards | JIS C-5101-4(IEC 60384) | | | | | | | | | | | | | |

Frequency Coefficient of Permissible Ripple Current

| Rated Voltage (V) | Capacitance (μF) | Frequency (Hz) | | | |
|-------------------|------------------|----------------|------|------|------|
| | | 50 | 120 | 1K | ≥20K |
| ≤ 100 | <100 | 0.75 | 1.00 | 1.57 | 2.00 |
| | 100 ~ 470 | 0.80 | 1.00 | 1.34 | 1.50 |
| | > 470 | 0.85 | 1.00 | 1.10 | 1.15 |
| ≥160 | 0.47 ~ 1000 | 0.85 | 1.00 | 1.40 | 1.50 |

The endurance of capacitors is reduced with internal heating produced by ripple current at the rate of having the lifetime with every 5°C rise. When long life performance is required in actual use, the rms ripple current has to be reduced.

Aluminum Electrolytic Capacitors

RSD Series

Dimensions (mm)

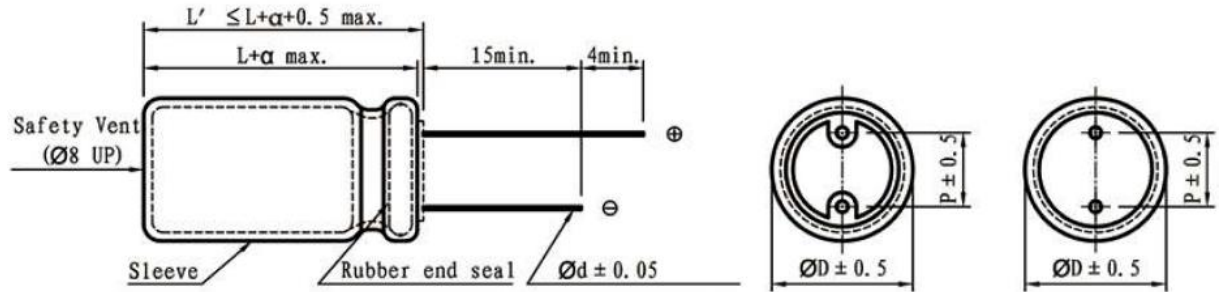

| | | | | | | | | | |
|-----------|-----|-----|-----|-----|-----|-----|-----|-----|-----|
| ØD | 5 | 6.3 | 8 | 10 | 13 | 16 | 18 | 20 | 22 |
| P | 2.0 | 2.5 | 3.5 | 5.0 | 5.0 | 7.5 | 7.5 | 10 | 10 |
| Ød | 0.5 | 0.5 | 0.5 | 0.6 | 0.6 | 0.8 | 0.8 | 0.8 | 0.8 |

| | |
|----------|------------------------------|
| α | (L < 16) 1.0 (L ≥ 16) 2.0 |
|----------|------------------------------|

Standard Ratings

DxL(mm); R.C.(mA rms) at 105°C 120Hz.

| Cap(µF) | V | 6.3 | | 10 | | 16 | | 25 | | 35 | | 50 | | 63 | |
|----------|--------|------|--------|------|--------|------|--------|------|--------|------|--------|------|--------|------|-------|
| | | Item | D x L | R.C. | D x L | R.C. | D x L | R.C. | D x L | R.C. | D x L | R.C. | D x L | R.C. | D x L |
| 0.1~0.47 | | | | | | | | | | | | 5x11 | 12 | | |
| 1 | | | | | | | | | | | | 5x11 | 16 | | |
| 2.2 | | | | | | | | | | | | 5x11 | 25 | | |
| 3.3 | | | | | | | | | | | | 5x11 | 35 | | |
| 4.7 | | | | | | | | 5x11 | 32 | 5x11 | 33 | 5x11 | 38 | | |
| 6.8 | | | | | | | | 5x11 | 37 | 5x11 | 39 | 5x11 | 50 | 5x11 | 52 |
| 10 | | | | | | 5x11 | 44 | 5x11 | 45 | 5x11 | 49 | 5x11 | 56 | 5x11 | 68 |
| 22 | 5x11 | 56 | 5x11 | 61 | 5x11 | 65 | 5x11 | 67 | 5x11 | 76 | 5x11 | 89 | 6.3x11 | 112 | |
| 33 | 5x11 | 68 | 5x11 | 79 | 5x11 | 81 | 5x11 | 85 | 5x11 | 93 | 6.3x11 | 130 | 8x12 | 145 | |
| 47 | 5x11 | 80 | 5x11 | 89 | 5x11 | 97 | 5x11 | 100 | 6.3x11 | 133 | 6.3x11 | 152 | 8x12 | 174 | |
| 56 | 5x11 | 92 | 5x11 | 103 | 5x11 | 107 | 5x11 | 121 | 6.3x11 | 136 | 6.3x11 | 171 | 8x12 | 187 | |
| 68 | 5x11 | 105 | 5x11 | 121 | 5x11 | 150 | 5x11 | 158 | 6.3x11 | 173 | 6.3x11 | 208 | 8x12 | 234 | |
| 100 | 5x11 | 113 | 5x11 | 145 | 6.3x11 | 157 | 6.3x11 | 179 | 8x12 | 197 | 8x14 | 270 | 10x13 | 292 | |
| 220 | 5x11 | 176 | 6.3x11 | 223 | 8x12 | 248 | 8x12 | 318 | 10x13 | 347 | 10x16 | 583 | 10x20 | 693 | |
| 330 | 6.3x11 | 240 | 6.3x11 | 275 | 8x12 | 361 | 10x13 | 391 | 10x16 | 490 | 10x20 | 737 | 13x21 | 770 | |
| 470 | 6.3x11 | 292 | 8x12 | 339 | 8x14 | 427 | 8x16 | 523 | 10x20 | 627 | 13x21 | 902 | 13x25 | 1012 | |
| 560 | 8x12 | 350 | 8x12 | 443 | 8x14 | 475 | 10x16 | 594 | 10x20 | 644 | 13x21 | 963 | 13x25 | 1177 | |
| 680 | 8x12 | 413 | 8x12 | 538 | 8x16 | 548 | 10x20 | 704 | 13x21 | 770 | 13x25 | 1040 | 16x26 | 1337 | |
| 1000 | 8x14 | 502 | 10x13 | 645 | 10x16 | 768 | 10x20 | 919 | 13x21 | 1194 | 13x25 | 1485 | 16x32 | 1848 | |
| 1500 | 10x16 | 669 | 10x20 | 798 | 10x20 | 993 | 13x21 | 1155 | 13x25 | 1370 | 16x32 | 1810 | 18x32 | 1975 | |
| 2200 | 10x20 | 912 | 10x20 | 988 | 13x21 | 1231 | 13x25 | 1447 | 16x26 | 1678 | 16x36 | 2200 | 18x35 | 2288 | |
| 3300 | 10x20 | 1154 | 13x21 | 1395 | 13x25 | 1560 | 16x26 | 1847 | 16x36 | 2145 | 18x35 | 2541 | 22x40 | 2695 | |
| 4700 | 13x21 | 1447 | 13x25 | 1671 | 16x26 | 1958 | 16x32 | 2310 | 18x35 | 2640 | 22x40 | 2915 | 22x50 | 3069 | |
| 6800 | 13x25 | 1795 | 16x26 | 2056 | 16x36 | 2374 | 18x35 | 2767 | 22x40 | 2761 | 22x50 | 3080 | | | |
| 10000 | 16x26 | 2112 | 16x36 | 2265 | 18x35 | 2903 | 22x40 | 2860 | 22x50 | 3210 | | | | | |
| 15000 | 16x36 | 2629 | 18x35 | 2820 | 22x40 | 2991 | 22x50 | 3350 | | | | | | | |
| 22000 | 18x40 | 2805 | 22x40 | 3620 | 22x50 | 3650 | | | | | | | | | |

| Cap (μ F) | V | 100 | | 160 | | 200 | | 250 | | 350 | | 400 | | 450 | |
|-------------------|---|--------|-------|--------|-------|--------|-------|--------|-------|--------|-------|-------|-------|-------|-------|
| | | Item | D x L | R.C. | D x L | R.C. | D x L | R.C. | D x L | R.C. | D x L | R.C. | D x L | R.C. | D x L |
| 0.1 | | 5x11 | 1.7 | | | | | | | | | | | | |
| 0.22 | | 5x11 | 3.7 | | | | | | | | | | | | |
| 0.33 | | 5x11 | 5.5 | | | | | | | | | | | | |
| 0.47 | | 5x11 | 12 | 6.3x11 | 22 | 6.3x11 | 22 | 6.3x11 | 26 | 6.3x11 | 24 | 8x12 | 26 | 8x12 | 25 |
| 1 | | 5x11 | 18 | 6.3x11 | 30 | 6.3x11 | 25 | 6.3x11 | 28 | 8x12 | 45 | 8x12 | 46 | 10x16 | 75 |
| 2.2 | | 5x11 | 28 | 6.3x11 | 35 | 6.3x11 | 30 | 8x12 | 62 | 8x12 | 62 | 8x12 | 70 | 10x16 | 80 |
| 3.3 | | 5x11 | 40 | 8x12 | 65 | 8x12 | 70 | 8x12 | 75 | 10x13 | 90 | 10x13 | 105 | 10x20 | 125 |
| 4.7 | | 5x11 | 46 | 8x12 | 70 | 8x12 | 75 | 10x13 | 120 | 10x13 | 95 | 10x16 | 130 | 10x20 | 135 |
| 6.8 | | 5x11 | 54 | 8x12 | 75 | 8x12 | 85 | 10x13 | 125 | 10x13 | 105 | 10x16 | 150 | 13x21 | 165 |
| 10 | | 6.3x11 | 69 | 10x13 | 90 | 10x16 | 140 | 10x16 | 150 | 10x20 | 145 | 10x20 | 175 | 13x21 | 175 |
| 22 | | 8x12 | 127 | 10x16 | 145 | 10x20 | 200 | 13x21 | 250 | 13x25 | 245 | 13x25 | 280 | 16x26 | 410 |
| 33 | | 8x12 | 167 | 10x20 | 200 | 13x21 | 250 | 13x21 | 260 | 16x26 | 420 | 16x26 | 420 | 16x32 | 470 |
| 47 | | 10x16 | 231 | 13x21 | 240 | 13x25 | 340 | 13x25 | 350 | 16x26 | 450 | 16x26 | 470 | 18x32 | 540 |
| 68 | | 10x16 | 271 | 13x21 | 303 | 13x25 | 360 | 16x26 | 540 | 16x32 | 490 | 16x32 | 510 | 18x35 | 570 |
| 82 | | 10x16 | 299 | 13x25 | 365 | 13x25 | 385 | 16x26 | 550 | 16x32 | 510 | 18x32 | 580 | 18x35 | 590 |
| 100 | | 10x20 | 402 | 16x26 | 520 | 16x26 | 550 | 16x32 | 630 | 18x32 | 620 | 18x35 | 650 | 18x40 | 750 |
| 120 | | 10x25 | 457 | 16x26 | 550 | 16x26 | 570 | 16x32 | 650 | 18x35 | 650 | 18x40 | 780 | 18x45 | 820 |
| 150 | | 13x21 | 579 | 16x26 | 580 | 16x32 | 650 | 18x32 | 720 | 18x40 | 850 | 22x40 | 920 | | |
| 220 | | 13x25 | 762 | 16x26 | 660 | 18x35 | 800 | 18x40 | 850 | | | | | | |
| 330 | | 16x26 | 952 | 18x35 | 800 | 22x35 | 1100 | | | | | | | | |
| 470 | | 16x32 | 1238 | 18x40 | 1100 | 22x40 | 1238 | | | | | | | | |
| 1000 | | 18x35 | 2321 | 22x50 | 1760 | | | | | | | | | | |

※ 13mm may be replaced by 12.5mm upon customer's request.

RSE Series

- Long life of RSA series.
- Suitable for LCD TV Power, SMPS.
- RoHS Compliant & Halogen Free

Specifications

| Items | Characteristics | | | | |
|--|--|---|--------------|------|------|
| Capacitance Tolerance | ± 20% (120Hz, 20°C) | | | | |
| Operating Temperature Range | -40 ~ +85°C | | -25 ~ +85°C | | |
| Rated Voltage Range | 400 ~ 420VDC | | 450 ~ 500VDC | | |
| Leakage Current | $I \leq 0.03CV + 20$ (μA) (After 3 minutes application of DC rated voltage, at 20 °C) | | | | |
| Dissipation Factor | Measurement Frequency: 120Hz. Temperature: 20°C | | | | |
| | Rated Voltage (V) | 400 ~ 420 | 450 | 460 | 500 |
| | tan δ(Max) | 0.15 | 0.20 | 0.20 | 0.20 |
| When nominal capacitance over 1000μF, tan δ shall be added 0.02 to the listed value with increase of every 1000μF. | | | | | |
| Low Temperature Stability | Measurement Frequency: 120Hz. | | | | |
| | Rated Voltage(V) | 400~420 | 450 | 460 | 500 |
| Impedance Ratio (Max) | Z(-25°C)/Z(20°C) | 3 | 3 | 6 | 6 |
| | Z(-40°C)/Z(20°C) | 6 | - | - | - |
| Load Life | 8000hours, with application of rated voltage at 85°C | | | | |
| | Capacitance Change | Within ± 20% of Initial Value | | | |
| | tan δ | 200% or less of Initial Specified Value | | | |
| | Leakage Current | Initial Specified Value or less | | | |
| Shelf Life | The following specifications shall be satisfied when the capacitors are restored to 20°C after exposing them for 1,000 hours 85°C without voltage applied. Before the measurement, the capacitor shall be preconditioned by applying voltage according to them 4.1 of JIS C5101-4. | | | | |
| | Capacitance Change | Within ± 20% of Initial Value | | | |
| | tan δ | 200% or less of Initial Specified Value | | | |
| | Leakage Current | Initial Specified Value or less | | | |
| Standards | JIS C 5101-4-1 (IEC 60384) | | | | |

Frequency Coefficient of Permissible Ripple Current

| Capacitance (μF) | Frequency (Hz) | | | | |
|------------------|----------------|------|------|------|------|
| | 120 | 10K | 30K | 50K | 100K |
| 10 ~ 150 | 1.00 | 1.50 | 1.60 | 1.75 | 2.00 |

The endurance of capacitors is reduced with internal heating produced by ripple current at the rate of halving the lifetime with every 5°C rise. When long life performance is required in actual use, the rms ripple current has to be reduced.

RSE Series

Dimensions (mm)

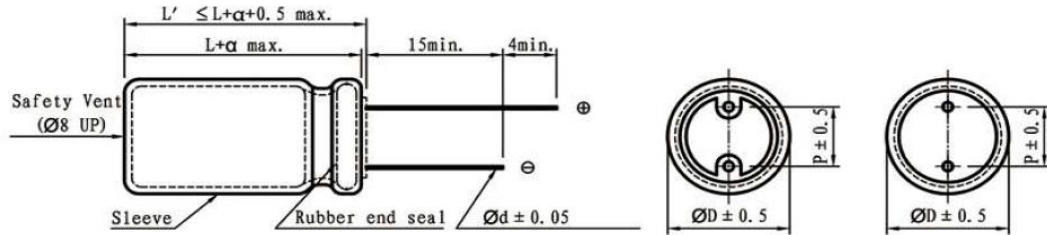

| | | | | | |
|----|-----|-----|-----|-----|-----|
| ØD | 10 | 13 | 16 | 18 | 20 |
| P | 5.0 | 5.0 | 7.5 | 7.5 | 10 |
| Ød | 0.6 | 0.6 | 0.8 | 0.8 | 0.8 |

| | |
|---|--------------|
| α | (L < 16) 1.0 |
| | (L ≥ 16) 2.0 |

Standard Ratings

D×L(mm) ; R.C.(mA rms) at 85°C 120Hz.

| Cap (µF) | V | 400 | | | | 420 | | | | 450 | | | |
|----------|---|-------|-------|-------|--------|-------|-------|--------|-------|-------|--------|--|--|
| | | Item | D x L | R.C. | | D x L | R.C. | | D x L | R.C. | | | |
| | | | | 120Hz | 100KHz | | 120Hz | 100KHz | | 120Hz | 100KHz | | |
| 10 | | 10x16 | 150 | 300 | 10x20 | 180 | 360 | 10x20 | 150 | 300 | | | |
| 22 | | 13x21 | 300 | 600 | 13x25 | 330 | 660 | 13x25 | 330 | 660 | | | |
| 47 | | 13x25 | 350 | 700 | 16x22 | 400 | 800 | 16x26 | 380 | 760 | | | |
| 56 | | 16x25 | 480 | 960 | 16x25 | 500 | 1000 | 16x32 | 450 | 900 | | | |
| 68 | | 16x32 | 563 | 1126 | 16x32 | 550 | 1100 | 16x36 | 530 | 1060 | | | |
| 82 | | 16x35 | 650 | 1300 | 16x36 | 630 | 1260 | 16x40 | 600 | 1200 | | | |
| 100 | | 16x40 | 780 | 1560 | 16x40 | 750 | 1500 | 16x45 | 720 | 1440 | | | |
| 120 | | 16x45 | 889 | 1778 | 16x45 | 840 | 1680 | 16x50 | 840 | 1680 | | | |
| 150 | | 16x50 | 980 | 1960 | 16x50 | 920 | 1840 | | | | | | |

| Cap (µF) | V | 460 | | | | 500 | | | |
|----------|---|-------|-------|-------|--------|-------|-------|--------|--|
| | | Item | D x L | R.C. | | D x L | R.C. | | |
| | | | | 120Hz | 100KHz | | 120Hz | 100KHz | |
| 10 | | 13x16 | 120 | 240 | 13x16 | 115 | 230 | | |
| 22 | | 16x25 | 250 | 500 | 16x25 | 230 | 460 | | |
| 47 | | 16x36 | 450 | 900 | 16x36 | 435 | 870 | | |
| 56 | | 16x40 | 500 | 1000 | 16x40 | 491 | 982 | | |
| 68 | | 16x45 | 580 | 1160 | 16x45 | 563 | 1126 | | |
| 82 | | 16x50 | 650 | 1300 | 16x50 | 630 | 1260 | | |
| 100 | | 18x45 | 730 | 1460 | 18x45 | 700 | 1400 | | |
| 120 | | 20x45 | 800 | 1600 | | | | | |

※ 13mm may be replaced by 12.5mm upon customer's request.

RSF Series

- On the basis of RSB series ripple promotion product.
- Suitable for LCD TV Power, SMPS.
- RoHS Compliant & Halogen Free

Specifications

| Items | Characteristics | | | | |
|--|---|---|--------------|------|------|
| Capacitance Tolerance | ± 20% (120Hz, 20°C) | | | | |
| Operating Temperature Range | -40 ~ +105°C | | -25 ~ +105°C | | |
| Rated Voltage Range | 400VDC | | 450 ~ 500VDC | | |
| Leakage Current | $I \leq 0.03CV + 20$ (μA) (After 3 minutes application of DC rated voltage, at 20 °C) | | | | |
| Dissipation Factor | Measurement Frequency: 120Hz. Temperature: 20°C | | | | |
| | Rated Voltage (V) | 400 | 450 | 460 | 500 |
| | tan δ(Max) | 0.15 | 0.20 | 0.20 | 0.20 |
| When nominal capacitance over 1000μF, tan δ shall be added 0.02 to the listed value with increase of every 1000μF. | | | | | |
| Low Temperature Stability | Measurement Frequency: 120Hz. | | | | |
| | Rated Voltage(V) | 400 | 450 | 460 | 500 |
| Impedance Ratio (Max) | Z(-25°C)/Z(20°C) | 3 | 3 | 6 | 6 |
| | Z(-40°C)/Z(20°C) | 6 | - | - | - |
| Load Life | 2000hours, with application of rated voltage at 105°C | | | | |
| | Capacitance Change | Within ± 20% of Initial Value | | | |
| | tan δ | 200% or less of Initial Specified Value | | | |
| | Leakage Current | Initial Specified Value or less | | | |
| Shelf Life | The following specifications shall be satisfied when the capacitors are restored to 20°C after exposing them for 1,000 hours 105°C without voltage applied. Before the measurement, the capacitor shall be preconditioned by applying voltage according to them 4.1 of JIS C5101-4. | | | | |
| | Capacitance Change | Within ± 20% of Initial Value | | | |
| | tan δ | 200% or less of Initial Specified Value | | | |
| | Leakage Current | Initial Specified Value or less | | | |
| Standards | JIS C 5101-4-1 (IEC 60384) | | | | |

Frequency Coefficient of Permissible Ripple Current

| Capacitance (μF) | Frequency (Hz) | | | | |
|------------------|----------------|------|------|------|------|
| | 120 | 10K | 30K | 50K | 100K |
| 10 ~ 150 | 1.00 | 1.50 | 1.60 | 1.75 | 2.00 |

The endurance of capacitors is reduced with internal heating produced by ripple current at the rate of halving the lifetime with every 5°C rise. When long life performance is required in actual use, the rms ripple current has to be reduced.

RSF Series

Dimensions (mm)

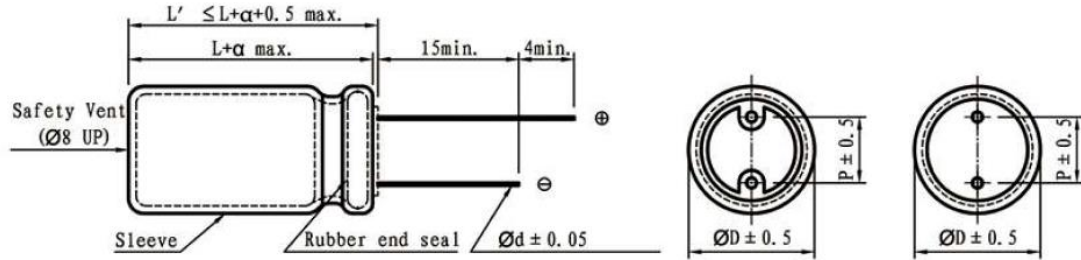

| | | | | | | |
|----|-----|-----|-----|-----|-----|-----|
| ØD | 10 | 13 | 16 | 18 | 20 | 22 |
| P | 5.0 | 5.0 | 7.5 | 7.5 | 10 | 10 |
| Ød | 0.6 | 0.6 | 0.8 | 0.8 | 0.8 | 0.8 |

| | |
|----------|--------------|
| α | (L < 16) 1.0 |
| | (L ≥ 16) 2.0 |

Standard Ratings

D×L(mm) ; R.C.(mA rms) at 105°C.120Hz.

| Cap (µF) | V Item | 400 | | 450 | | 460 | | 500 | | | | |
|-------------|-----------|-------|-------|--------|-------|-------|--------|-------|-------|--------|-------|--------|
| | | D x L | R.C. | | D x L | R.C. | | D x L | R.C. | | | |
| | | | 120Hz | 100KHz | | 120Hz | 100KHz | | 120Hz | 100KHz | 120Hz | 100KHz |
| 10 | 10x16 | 100 | 200 | 10x20 | 130 | 260 | 10x20 | 120 | 240 | 13x21 | 78 | 156 |
| 15 | 10x20 | 200 | 400 | 13x21 | 200 | 400 | 13x21 | 150 | 300 | 13x21 | 100 | 200 |
| 22 | 13x21 | 280 | 560 | 13x21 | 300 | 600 | 13x25 | 300 | 600 | 13x25 | 190 | 380 |
| 33 | 13x21 | 330 | 660 | 13x25 | 400 | 800 | 16x25 | 400 | 800 | 16x25 | 270 | 540 |
| 47 | 13x25 | 380 | 760 | 16x25 | 500 | 1000 | 18x26 | 500 | 1000 | 18x26 | 300 | 600 |
| 56 | 16x25 | 500 | 1000 | 18x26 | 600 | 1200 | 18x26 | 550 | 1100 | 18x32 | 330 | 660 |
| 68 | 16x25 | 650 | 1300 | 18x32 | 690 | 1380 | 18x32 | 600 | 1200 | 18x35 | 450 | 900 |
| 82 | 18x26 | 750 | 1500 | 18x32 | 750 | 1500 | 18x32 | 650 | 1300 | 18x40 | 560 | 1120 |
| 100 | 18x32 | 800 | 1600 | 18x35 | 780 | 1560 | 18x35 | 750 | 1500 | 18x45 | 650 | 1300 |
| 120 | 18x35 | 850 | 1700 | 18x40 | 850 | 1700 | 18x40 | 800 | 1600 | 20x45 | 700 | 1400 |
| 150 | 18x40 | 900 | 1800 | 18x45 | 900 | 1800 | 20x45 | 827 | 1654 | 22x45 | 750 | 1500 |

※ 13mm may be replaced by 12.5mm upon customer's request.

RSG Series

- -55°C low temperature resistant products.
- Suitable for LED, Intelligent electronic meter and outdoor power supply
- RoHS Compliance.

Specifications

| Items | Characteristics | | |
|-----------------------------|---|---|------|
| Capacitance Tolerance | ±20 % (120Hz, 20°C) | | |
| Operating Temperature Range | -55°C ~ +105°C | | |
| Rated Voltage Range | 400 ~ 450VDC | | |
| Leakage Current | $I \leq 0.03CV + 20$ (μA) (After 3 minutes application of DC rated voltage, at 20°C) | | |
| Dissipation Factor(tan δ) | Measurement Frequency: 120Hz. Temperature: 20°C | | |
| | Rated Voltage(V) | 400 | 450 |
| | tan δ (Max) | 0.20 | 0.20 |
| | When nominal capacitance over 1000μF, tan δ shall be added 0.02 to the listed value with increase of every 1000 μF. | | |
| Low Temperature Stability | Measurement Frequency: 120Hz. | | |
| | Rated Voltage(V) | 400 | 450 |
| Impedance Ratio (Max) | Z(-25°C)/ Z(20°C) | 2 | 2 |
| | Z(-40°C)/ Z(20°C) | 3 | 3 |
| Load Life | The following specifications shall be satisfied when the capacitors are restored to 20°C after subjected to DC voltage with the rated ripple current is applied for 2,000 hours at 105°C. | | |
| | Capacitance Change | within ±20 % of Initial Value | |
| | Tan δ | 200% or less of Initial Specified Value | |
| | Leakage Current | Initial Specified Value or less | |
| Shelf Life | The following specifications shall be satisfied when the capacitors are restored to 20°C after exposing them for 1000hours 105°C without voltage applied. Before the measurement. The Capacitance shall be preconditioned by applying voltage according to them 4.1 of JIS C5101-4. | | |
| | Capacitance Change | within ±20 % of Initial Value | |
| | Tan δ | 200% or less of Initial Specified Value | |
| | Leakage Current | Initial Specified Value or less | |
| Standards | JIS C 5101-4-1 (IEC 60384) | | |

Frequency Coefficient of permissible Ripple Current

| Capacitance (μF) | Frequency (Hz) | | | | |
|------------------|----------------|------|------|------|------|
| | 120 | 10K | 30K | 50K | 100K |
| 10 ~ 82 | 1.00 | 1.75 | 2.25 | 2.23 | 2.50 |
| 100 ~ 150 | 1.00 | 1.67 | 2.05 | 2.15 | 2.25 |

The endurance of capacitors is reduced with internal heating produced by ripple current at the rate of halving the lifetime with every 5°C rise. When long life performance is required in actual use. The rms ripple current has to be reduced.

DIMENSIONS (mm)

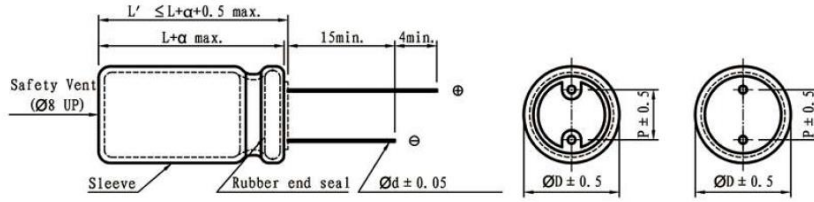

| | | | | |
|-----|-----|-----|-----|-----|
| Ø D | 10 | 13 | 16 | 18 |
| P | 5.0 | 5.0 | 7.5 | 7.5 |
| Ø d | 0.6 | 0.6 | 0.8 | 0.8 |

| | |
|----------|--------------|
| α | (L < 16) 1.0 |
| | (L > 16) 2.0 |

STANDARD RATINGS

DxL(mm) ; R.C.(mA rms) at 105°C 120Hz

| Cap (µF) | V | Item | 400 | | 450 | | | |
|-------------|---|-------|-------|-------|--------|-------|-------|--------|
| | | | D x L | R.C. | | D x L | R.C. | |
| | | | | 100Hz | 120KHz | | 100Hz | 120KHz |
| 10 | | 10x16 | 150 | 375 | 10x20 | 105 | 263 | |
| 15 | | 10x20 | 170 | 425 | 13x21 | 130 | 325 | |
| 22 | | 13x21 | 250 | 625 | 13x25 | 210 | 525 | |
| 33 | | 13x25 | 350 | 875 | 16x22 | 270 | 675 | |
| 47 | | 16x22 | 480 | 1200 | 18x26 | 450 | 1125 | |
| 56 | | 16x25 | 500 | 1250 | 18x26 | 550 | 1375 | |
| 68 | | 18x26 | 550 | 1375 | 18x32 | 600 | 1500 | |
| 82 | | 18x26 | 600 | 1500 | 18x32 | 650 | 1625 | |
| 100 | | 18x32 | 680 | 1530 | 18x35 | 750 | 1688 | |
| 120 | | 18x35 | 750 | 1688 | 18x40 | 800 | 1800 | |
| 150 | | 18x40 | 800 | 1800 | 18x45 | 900 | 2025 | |

※13mm may be replaced by 12.5mm upon customer's request.

Aluminum Electrolytic Capacitor – Package Specification

Taping Specification for Automatic insertion

APPLICATIONS

- These specifications include taped single-ended electrolytic capacitors with the body diameters from 4.0 to 16mm.
- Suitable to be used in automatic lead preparation and insertion machines.

DESCRIPTION

- Body tape requirements are shown from Fig.1 to Fig.6
- Polarity of capacitors shall be oriented in one direction.
- Leader tapes shall not be provided before the first and after the last capacitor on tape.
- Up to 3 capacitors consecutively missing on tape is permitted but a designed quantity of capacitors shall be packed in each case.
- Removal faulty capacitors from the tape shall be by pulling out or by cutting off leads. Cut off leads remaining on tape shall not protrude more than 2.0 mm from tape edge.

DIAGRAM OF TAPING DIMENSIONS

(Unit = mm)

Fig. 1 (Ø4 - Ø8)

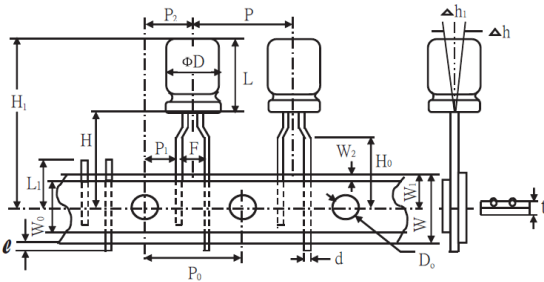

Fig. 2 (Ø4 - Ø5)

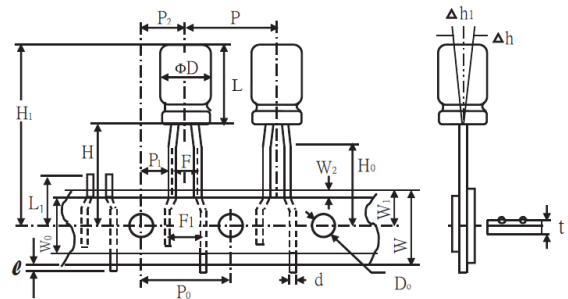

Fig. 3 (Ø5 - Ø8)

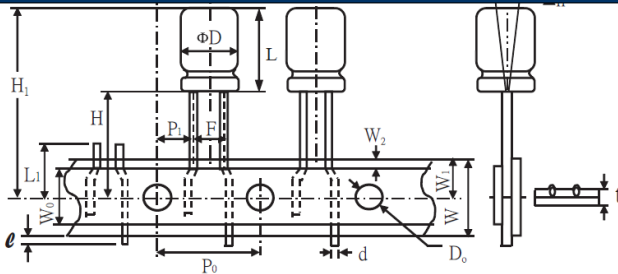

Fig. 4 (Ø10)

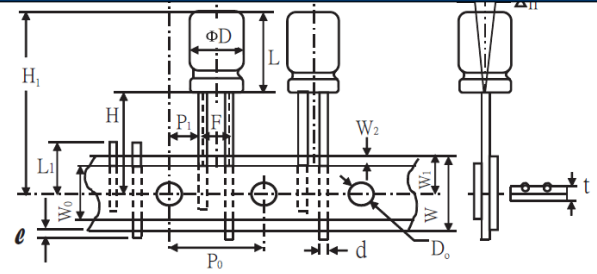

Fig. 5 (Ø12 - Ø13)

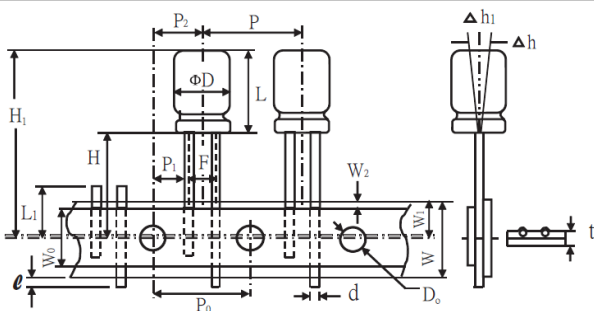
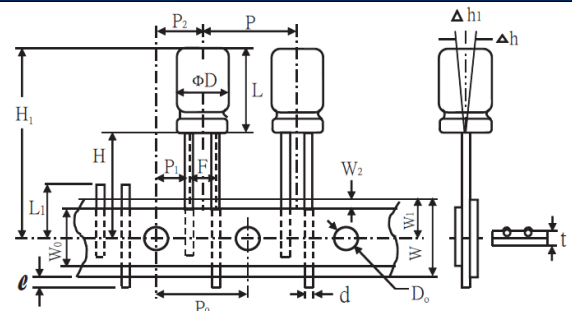

Fig. 6 (Ø16)



For Automatic Insertion Taping Capacitors

TAPING DIMENSIONS (mm)

| Items | Symbol | Case Size | | | | | | | | | | Tolerance | Remark | | |
|---|-----------------|-----------|-------|-------|-------|-------|------|-------|--------|-------|-------|-----------|-------------------------------|--------|----------------------------|
| | | 4x5 | 5x5 | | 4x7 | 5x7 | | 5x11 | 6.3x11 | 8x12 | 10x13 | | | 10x16 | 10x20 |
| | | | 6.3x5 | 8x5 | | 6.3x7 | 8x7 | | | | | | | | |
| Lead Wire Diameter | d | 0.45 | 0.45 | 0.45 | 0.50 | 0.50 | | | 0.60 | | | ± 0.05 | | | |
| Body Height | L | 6 | | 8 | | 12 | | 13 | 14 | 18 | 22 | max | | | |
| Intervals of Bodies | P | 12.70 | | | | | | | | | | ± 1.0 | | | |
| Intervals of Punched Holes | P ₀ | 12.70 | | | | | | | | | | ± 0.2 | | | |
| Distance between Holes and Lead Wire | P ₁ | 3.85 | | | | | | | | | | ± 0.7 | Fig.1 Fig.4 Fig.2 Fig.3 | | |
| | | 5.35 | 5.10 | 5.10 | 5.10 | 5.10 | 5.10 | 5.10 | | | | | | | |
| Distance between Holes and Body Center | P ₂ | 6.35 | | | | | | | | | | ± 1.0 | | | |
| Distance between Lead and Lead | F | 5.00 | | | | | | | | | | + 0.8 | Fig.1 Fig.4 Fig.2 | | |
| | | 2.50 | 2.50 | 2.50 | 2.50 | 2.50 | | | | | | | | | |
| | | 1.5 | 2.0 | 2.5 | 2.50 | 3.50 | 2.00 | 2.50 | 3.50 | | | | - 0.2 | Fig.3 | |
| Distance between Lead and Lead | F ₁ | 5.00 | | | | | | | | | | | Fig.2 Fig.3 | | |
| Base Tape Width | W | 18.00 | | | | | | | | | | ± 0.5 | | | |
| Adhesive Tape Width | W ₀ | 11.00 | 11.00 | 11.00 | 11.00 | 11.00 | | | 12.00 | | | min | | | |
| Deviation between Holes and Base Tape | W ₁ | 9.00 | | | | | | | | | | ± 0.5 | | | |
| Deviation between Adhesive and Base Tape | W ₂ | 1.50 | | | | | | | | | | max | | | |
| Deviation between Body Bottom and Tape Center | H | 17.50 | | | | 18.50 | | | | 18.50 | | 18.50 | | ± 0.75 | Fig.1 Fig.4 Fig.2 Fig.3 |
| | | 17.50 | 18.50 | 17.50 | 18.50 | | | | | | | | | | |
| Lead Wire Clinched Height | H ₀ | 15.00 | | | | 16.00 | | | | 16.00 | | | | ± 0.50 | |
| | | 15.00 | 16.00 | 15.00 | 16.00 | | | | | | | | | | |
| Distance between Body Top and Tape Center | H ₁ | 27.50 | | | 32.50 | | | 33.00 | 36.00 | 41.00 | | | | max | |
| Punched Hole Diameter | D ₀ | 4.00 | | | | | | | | | | ± 0.3 | | | |
| Lead Wire Protrusion | l | 1.00 | | | | | | | | | | max | | | |
| Length of not Good Lead Slit | L ₁ | 11.00 | | | | | | | | | | max | | | |
| Base and Adhesive Tape Thickness | t | 0.70 | | | | | | | | | | ± 0.2 | | | |
| Deviation of Body Alignment | Δh | 0 | | | | | | | | | | ± 2.0 | | | |
| Deviation of Body Alignment | Δh ₁ | 0 | | | | | | | | | | ± 2.0 | | | |

TAPING DIMENSIONS (mm)

| Items | Symbol | Case Size | | | | | | | | Tolerance | Remark |
|---|-----------------|-----------|-------|-------|-------|-------|-------|-------|-----|------------|-------------|
| | | 12.5x21 | 13x21 | 13x25 | 13x30 | 16x26 | 16x32 | 16x36 | | | |
| Lead Wire Diameter | d | 0.60 | | | | | | | | ± 0.05 | |
| Body Height | L | 23.00 | 23.00 | 27.00 | 32.00 | 28.00 | 34.00 | 38.00 | max | | |
| Intervals of Bodies | P | 15.00 | | | | | | | | ± 1.0 | |
| Intervals of Punched Holes | P ₀ | 15.00 | | | | | | | | ± 0.2 | |
| Distance between Holes and Lead Wire | P ₁ | 5.00 | | | | 3.75 | | | | ± 0.7 | |
| Distance between Holes and Bodies | P ₂ | 7.50 | | | | | | | | ± 1.0 | |
| Distance between Lead and Lead | F | 5.00 | | | | 7.50 | | | | + 0.8 -0.2 | Fig.5 Fig.6 |
| Base Tape Width | W | 18.00 | | | | | | | | ± 0.5 | |
| Adhesive Tape Width | W ₀ | 12.00 | | | | | | | | min | |
| Deviation between Holes and Base Tape | W ₁ | 9.00 | | | | | | | | ± 0.5 | |
| Deviation between Adhesive and Base Tape | W ₂ | 1.50 | | | | | | | | max | |
| Deviation between Body Bottom and Tape Center | H | 18.50 | | | | | | | | ± 0.75 | Fig.5 Fig.6 |
| Distance between Body Top and Tape Center | H ₁ | 40.50 | 40.50 | 45.50 | 50.50 | 46.50 | 53.50 | 56.50 | max | | |
| Punched Hole Diameter | D ₀ | 4.00 | | | | | | | | ± 0.3 | |
| Lead Wire Protrusion | l | 1.00 | | | | | | | | max | |
| Length of not Good Lead Slit | L ₁ | 11.00 | | | | | | | | max | |
| Base and Adhesive Tape Thickness | t | 0.70 | | | | | | | | ± 0.2 | |
| Deviation of Body Alignment | Δh | 0 | | | | | | | | ± 2.0 | |
| Deviation of Body Alignment | Δh ₁ | 0 | | | | | | | | ± 2.0 | |

With Terminals or Forms as below, it is easier to insert the units into P.C. Boards and this contributes to a Higher Mounting Efficiency.

SHAPE (S)

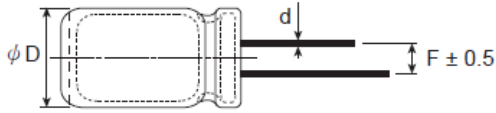

SHAPE (C)

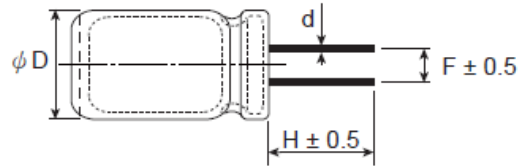

SHAPE (D)

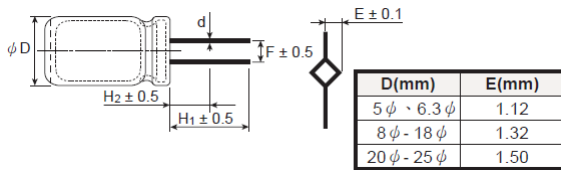

SHAPE (H)

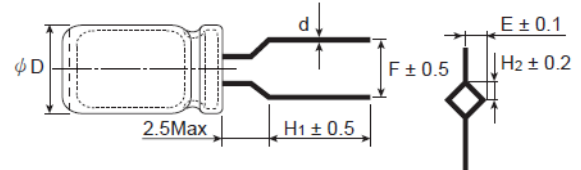

SHAPE (F)

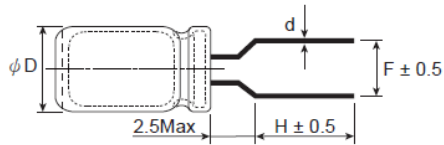

SHAPE (B)

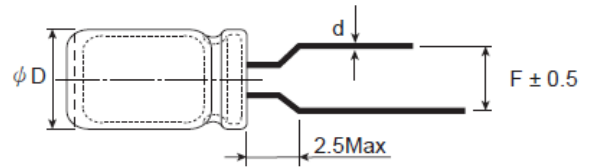

SHAPE (Z)

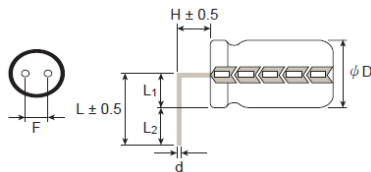

SHAPE (L)

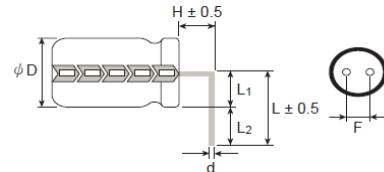

SPECIFICATION INFORMATION

| Shape No. | Cutting & Forming Methods | ØD | Ø4 | Ø5 | Ø6.3 | Ø8 | Ø10 | Ø12.5 | Ø13 | Ø16 | Ø18 | Ø22 | | |
|-----------|---------------------------|----------------|------|-----|------|-------------------|-----|-------|-----|-----|-----|------|-----|--|
| S | Long Lead | F | 1.5 | 2 | 2.5 | 3.5 | 5 | 5 | 5 | 7.5 | 7.5 | 10 | | |
| | | d | 0.45 | 0.5 | 0.5 | 0.5 | 0.6 | 0.6 | 0.6 | 0.8 | 0.8 | 0.8 | | |
| C | Lead Cut Only | F | 1.5 | 2 | 2.5 | 3.5 | 5 | 5 | 5 | 7.5 | 7.5 | 10 | | |
| | | H | 5 | 5 | 5 | 5 | 5 | 5 | 5 | 5 | 5 | 5 | | |
| D | Lead Cut and Crimp | d | 0.45 | 0.5 | 0.5 | 0.5 | 0.6 | 0.6 | 0.6 | 0.8 | 0.8 | 0.8 | | |
| | | F | — | — | — | — | 5 | 5 | 5 | 7.5 | 7.5 | 10 | | |
| | | H ₁ | — | — | — | — | 5 | 5 | 5 | 5 | 5 | 5 | | |
| | | H ₂ | — | — | — | — | 1.8 | 1.8 | 1.8 | 1.8 | 1.8 | 1.8 | | |
| F | Lead Cut and Form | d | — | — | — | — | 0.6 | 0.6 | 0.6 | 0.8 | 0.8 | 0.8 | | |
| | | F | 5 | 5 | 5 | 5 | — | — | — | — | — | — | | |
| | | H | 4 | 5 | 5 | 5 | — | — | — | — | — | — | | |
| H | Lead Cut, Crimp and Form | d | 0.45 | 0.5 | 0.5 | 0.5 | — | — | — | — | — | — | | |
| | | F | 5 | 5 | 5 | 5 | — | — | — | — | — | — | | |
| | | H ₁ | 4 | 5 | 5 | 5 | — | — | — | — | — | — | | |
| | | H ₂ | 1.8 | 1.8 | 1.8 | 1.8 | — | — | — | — | — | — | | |
| B | Forming Only | d | 0.45 | 0.5 | 0.5 | 0.5 | — | — | — | — | — | — | | |
| | | F | 5 | 5 | 5 | 5 | — | — | — | — | — | — | | |
| L / Z | Lead Cutting and Bending | F | 1.5 | 2 | 2.5 | 3.5 | 5 | 5 | 5 | 7.5 | 7.5 | 10 | | |
| | | H | 2 | 2 | 2 | 2.5 or 3.5 or 5.0 | | | | | | | | |
| | | L ₁ | 2.2 | 2.7 | 3.6 | 4.5 | 5.3 | 6.6 | 6.8 | 8.4 | 9.4 | 11.4 | | |
| | | L ₂ | 3.5 | 3.5 | 3.5 | 3.5 | 3.5 | 3.5 | 3.5 | 3.5 | 3.5 | 3.5 | | |
| | | d | 0.45 | 0.5 | 0.5 | 0.5 | 0.5 | 0.6 | 0.6 | 0.6 | 0.8 | 0.8 | 0.8 | |

(mm)

D= Ø22 to Ø35 mm YL

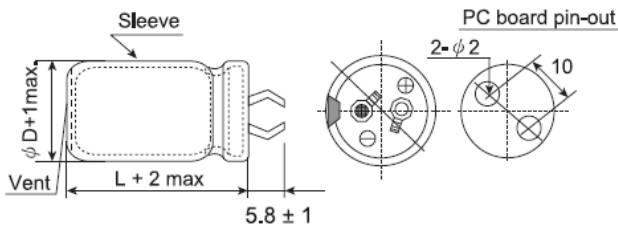

D= Ø22 to Ø35 mm YS

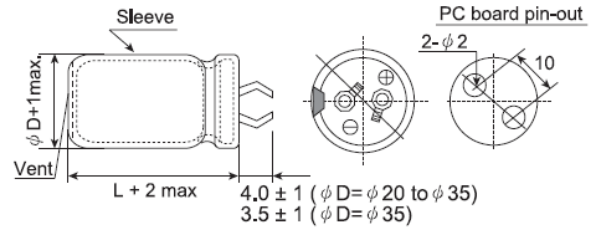

D= Ø25 to Ø51 mm G

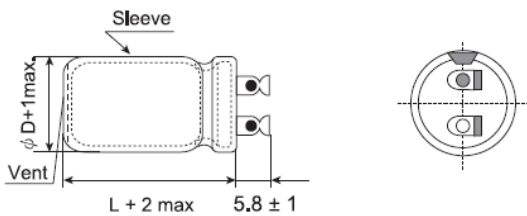

D= Ø35 to Ø51 mm ST

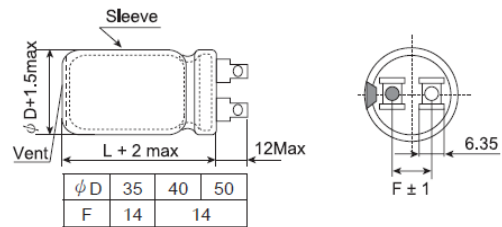

D= Ø35 to Ø40 mm PCS

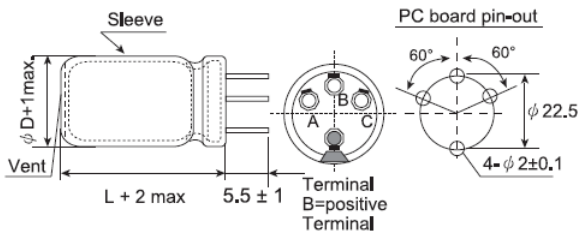

D= Ø35 to Ø40 mm PCY

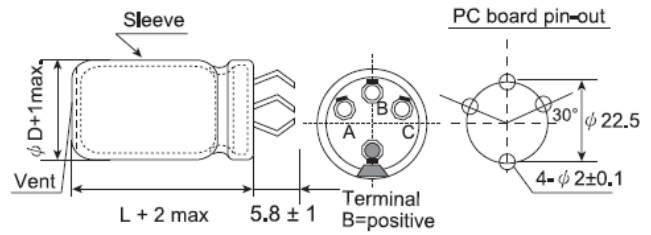

D= Ø35 to Ø40 mm PCU

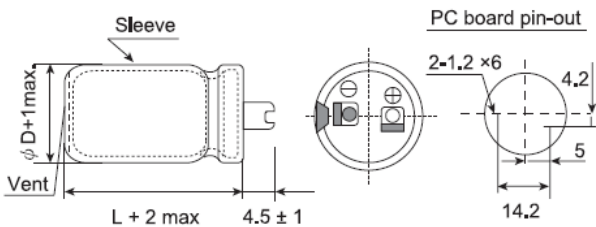

D= Ø22 to Ø30 mm PCB

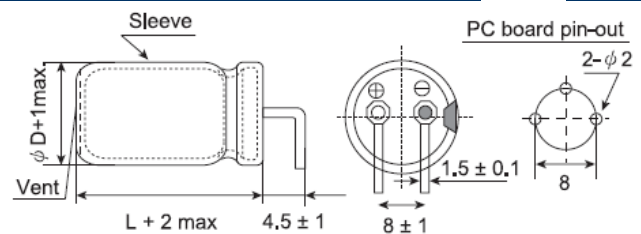

D= Ø40 to Ø50 mm U

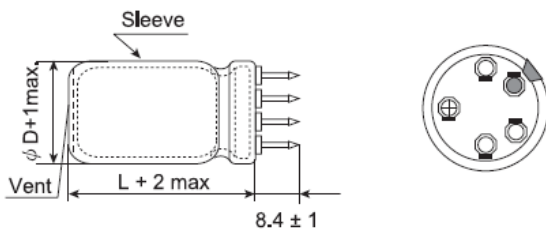

D= Ø35 to Ø100 mm W

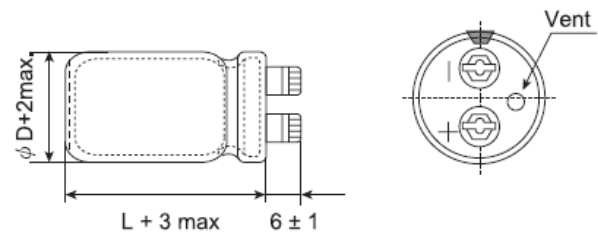

CAUTION:

- Use the blank terminals for mechanical support only.
- The blank terminals must not be connected to any copper on PC boards.
- Be sure to electrically isolate from negative the positive terminals.

Taping Package

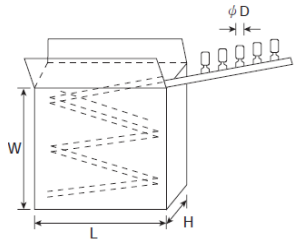

Taping and Reel

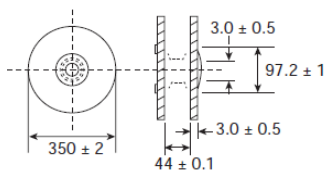

| Item | Taping Packing | | | | | | Tape and Reel | |
|-------------|----------------|----------|----------|----------|-----------|-------------|---------------|------------|
| | ØD (mm) | W±5 (mm) | L±5 (mm) | H±5 (mm) | Qty (pcs) | G.W. Kg/box | Box/ Carton | Qty. (pcs) |
| 4 | 235 | 327 | 54 | 2,500 | 0.89 | 10 | 1,800 | |
| 5 | 235 | 327 | 54 | 2,000 | 0.99 | 10 | 1,200 | |
| 6.3 | 235 | 327 | 54 | 1,500 | 1.12 | 10 | 1,000 | |
| 8 | 265 | 327 | 51 | 1,000 | 1.48 | 10 | 800 | |
| 10 (L≤16) | 235 | 330 | 57 | 600 | 1.29 | 10 | 600 | |
| 10 (L≤20) | 235 | 330 | 57 | 600 | 1.48 | 10 | 600 | |
| 12.5 (L≤21) | 280 | 315 | 65 | 400 | 1.73 | 6 | 400 | |
| 13 (L≤21) | 280 | 315 | 65 | 400 | 1.95 | 6 | 400 | |
| 13 (L≤25) | 280 | 315 | 65 | 400 | 2.35 | 6 | | |
| 13 (L≤30) | 290 | 310 | 72 | 400 | 2.65 | 6 | | |
| 16 (L≤26) | 290 | 310 | 72 | 250 | 1.85 | 6 | | |
| 16 (L≤32) | 290 | 310 | 72 | 250 | 2.25 | 6 | | |
| 16 (L≤36) | 290 | 310 | 72 | 250 | 2.45 | 6 | | |

Chip Packing

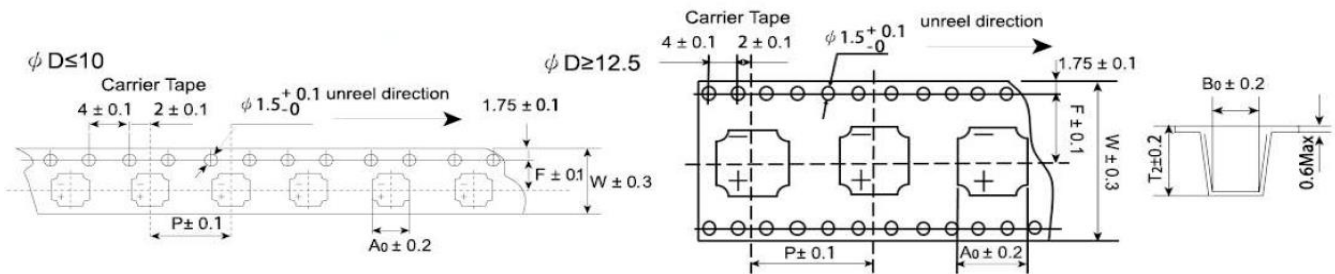

| Size | Item | | | | | |
|------------------|------|------|------|--------------|--------------|------------|
| | W | P | F | A0 | B0 | T2 |
| Ø4 x 5.5~5.6 L | 12.0 | 8.0 | 5.5 | 5.0 | 5.0 | 5.8 |
| Ø4 x 5.7~6.3 L | 12.0 | 8.0 | 5.5 | 5.0 | 5.0 | 6.3 |
| Ø5 x 5.3~5.6 L | 12.0 | 12.0 | 5.5 | 5.0 | 5.0 | 5.9 |
| Ø5 x 5.7~6.3 L | 12.0 | 12.0 | 5.5 | 5.0 | 5.0 | 6.3 |
| Ø5 x 6.4~7.0 L | 12.0 | 12.0 | 5.5 | 5.0 | 5.0 | 7.6 |
| Ø6.3 x 4.5 L | 16.0 | 12.0 | 7.5 | 7.0 | 7.0 | 4.8 |
| Ø6.3 x 5.3~5.6 L | 16.0 | 12.0 | 7.5 | 7.0 | 7.0 | 5.9 |
| Ø6.3 x 5.7~6.3 L | 16.0 | 12.0 | 7.5 | 7.0 | 7.0 | 6.5 |
| Ø6.3 x 7~8 L | 16.0 | 12.0 | 7.5 | 7.0 | 7.0 | 8.3 |
| Ø6.3 x 8.1~9 L | 16.0 | 12.0 | 7.5 | 7.0 | 7.0 | 9.3 |
| Ø8 x 6~7 L | 16.0 | 12.0 | 7.5 | 8.7 | 8.7 | 6.9 |
| Ø8 x 10~11 L | 24.0 | 16.0 | 11.5 | 8.7/9.4(G) | 8.7/9.4(G) | 11/11.4(G) |
| Ø10 x 7.7 L | 24.0 | 16.0 | 11.5 | 10.7 | 10.7 | 8.7 |
| Ø10 x 10~11 L | 24.0 | 16.0 | 11.5 | 10.7/11.4(G) | 10.7/11.4(G) | 11/11.4(G) |
| Ø10 x 12~13 L | 24.0 | 16.0 | 11.5 | 10.7 | 10.7 | 13.1 |
| Ø10 x 16~17 L | 24.0 | 16.0 | 11.5 | 10.7 | 10.7 | 17.5 |
| Ø12.5 x 13~14 L | 32.0 | 24.0 | 14.2 | 13.4/13.7(G) | 13.4/13.7(G) | 15 |
| Ø12.5 x 16~17 L | 32.0 | 24.0 | 14.2 | 13.4/13.7(G) | 13.4/13.7(G) | 17.5 |
| Ø16 x 16~17 L | 44.0 | 28.0 | 20.2 | 17.5 | 17.5 | 17.5 |
| Ø16 x 21~22 L | 44.0 | 28.0 | 20.2 | 17.5 | 17.5 | 23.0 |
| Ø18 x 16~17 L | 44.0 | 32.0 | 20.2 | 19.5 | 19.5 | 17.5 |
| Ø18 x 21~22 L | 44.0 | 32.0 | 20.2 | 19.5 | 19.5 | 23.0 |

Chip and Reel

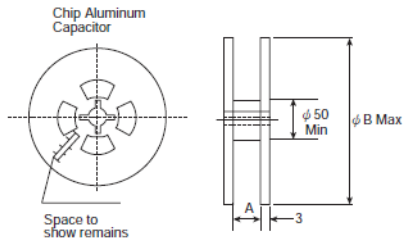

| Size | Ø4 x 5 | Ø6.3 | Ø8 | Ø10 | Ø12.5 | Ø16 x 18 |
|------|--------|------|-----|-----|-------|----------|
| A | 14 | 18 | 26 | 26 | 34 | 46 |
| B | 382 | 382 | 382 | 382 | 382 | 382 |

Package Quantity

| Size | Q'ty / Reel | Inner Box / measurement (mm) | | Outer Carton / measurement (mm) | |
|-------------------|-------------|------------------------------|-------------|---------------------------------|-------------|
| 04 | 2000 | 10000 | 385x106x385 | 20000 | 403x255x412 |
| 05 | 1000 | 5000 | 385x106x385 | 10000 | 403x255x412 |
| Ø6.3 x 4 ~ 8 L | 1000 | 5000 | 385x125x385 | 10000 | 403x293x412 |
| Ø6.3 x 8.4 L | 800 | 4000 | 385x125x385 | 8000 | 403x293x412 |
| Ø0 6.3 x 7.7L | 1000 | 5000 | 385x125x385 | 10000 | 403x293x412 |
| Ø8 x 6 ~ 7L | 1000 | 5000 | 385x125x385 | 10000 | 403x293x412 |
| Ø08 x 10 ~ 11 L | 500 | 1500 | 385x106x385 | 3000 | 403x255x412 |
| Ø10 x 7 ~ 11 L | 500 | 1500 | 385x106x385 | 3000 | 403x255x412 |
| Ø10 x 12 ~ 13 L | 400 | 1200 | 385x106x385 | 2400 | 403x255x412 |
| Ø10 x 16 ~ 17 L | 300 | 900 | 385x106x385 | 1800 | 403x255x412 |
| Ø12.5 x 13 ~ 14L | 250 | 750 | 385x125x385 | 1500 | 403x293x412 |
| Ø12.5 x 16 ~ 17L | 200 | 600 | 385x125x385 | 1200 | 403x293x412 |
| Ø16\18 x 16 ~ 17L | 200 | 400 | 385x106x385 | 800 | 403x255x412 |
| Ø16\18 x 21 ~ 22L | 100 | 200 | 385x106x385 | 400 | 403x255x412 |

Unit: (mm)

| Type of Product | Dim (DxL) | Bags / Inner Box | Layer Quantity | Quantity (pcs/bag) | Total Quantity (pcs/carton) | Wt (kg/bag) | Size of Inner Box | Size of Out Box (mm) |
|------------------------|-----------|------------------|----------------|--------------------|-----------------------------|-------------|-----------------------------|-----------------------------|
| Radial (Standard Bulk) | 4x5 | 20 | 2 | 1000 | 40000 | 0.19 | 272 X 260 X 135 | 546 X 279 X 160 |
| | 4x7 | 20 | 2 | 1000 | 40000 | 0.23 | | |
| | 5x5 | 15 | 2 | 1000 | 30000 | 0.25 | | |
| | 5x7 | 10 | 2 | 1000 | 20000 | 0.32 | | |
| | 5x11 | 10 | 2 | 1000 | 20000 | 0.43 | | |
| | 6.3x5 | 10 | 2 | 1000 | 20000 | 0.37 | | |
| | 6.3x7 | 10 | 2 | 1000 | 20000 | 0.45 | | |
| | 6.3x11 | 8 | 2 | 1000 | 16000 | 0.60 | | |
| | 8x5 | 10 | 2 | 500 | 10000 | 0.23 | | |
| | 8x9 | 10 | 2 | 500 | 10000 | 0.42 | | |
| | 8x12 | 10 | 2 | 500 | 10000 | 0.49 | | |
| | 8x14 | 8 | 2 | 500 | 8000 | 0.63 | | |
| | 8x16 | 6 | 2 | 500 | 6000 | 0.69 | | |
| | 8x20 | 6 | 2 | 500 | 6000 | 0.71 | | |
| 10x13 | 11 | 2 | 200 | 4400 | 0.38 | | | |
| 10x16 | 9 | 2 | 200 | 3600 | 0.45 | | | |
| Radial (Special Bulk) | 4x5 | 15 | 2 | 1000 | 30000 | 0.13 | 365 X 245 X 230 | 365 X 245 X 230 |
| | 4x7 | 15 | 2 | 1000 | 30000 | 0.18 | | |
| | 5x5 | 10 | 2 | 1000 | 20000 | 0.19 | | |
| | 5x7 | 10 | 2 | 1000 | 20000 | 0.27 | | |
| | 5x11 | 10 | 2 | 1000 | 20000 | 0.40 | | |
| | 6.3x5 | 10 | 2 | 1000 | 20000 | 0.31 | | |
| | 6.3x7 | 10 | 2 | 1000 | 20000 | 0.40 | | |
| | 6.3x11 | 10 | 2 | 1000 | 20000 | 0.55 | | |
| | 8x5 | 20 | 2 | 250 | 10000 | 0.11 | | |
| | 8x7 | 20 | 2 | 250 | 10000 | 0.15 | | |
| | 8x9 | 20 | 2 | 250 | 10000 | 0.20 | | |
| | 8x12 | 20 | 2 | 250 | 10000 | 0.23 | | |
| | 8x14 | 20 | 2 | 250 | 10000 | 0.28 | | |
| | 8x16 | 20 | 2 | 250 | 10000 | 0.33 | | |
| | 8x20 | 18 | 2 | 250 | 9000 | 0.39 | | |
| | 8x25 | 14 | 2 | 250 | 7000 | 0.48 | | |
| Cutting | 4x5 | 30 | 2 | 1000 | 60000 | 0.13 | 267 X 260 X 135 | 546 X 279 X 160 |
| | 4x7 | 30 | 2 | 1000 | 60000 | 0.18 | | |
| | 5x5 | 20 | 2 | 1000 | 40000 | 0.19 | | |
| | 5x7 | 20 | 2 | 1000 | 40000 | 0.27 | | |
| | 5x11 | 15 | 2 | 1000 | 30000 | 0.40 | | |
| | 6.3x5 | 15 | 2 | 1000 | 30000 | 0.31 | | |
| | 6.3x7 | 15 | 2 | 1000 | 30000 | 0.40 | | |

| Type of Product | Dim (DxL) | Quantity (pcs/Inner Box) | Layer Qty | Total Qty (pcs/Carton) | Unit Wt. (kg/pcs) | Gross (kg/Inner Box) | Size of Inner Box (mm) | Size of Out Box (mm) |
|-----------------|-----------|--------------------------|-----------|------------------------|-------------------|----------------------|------------------------|----------------------|
| Screw Terminal | 35x120 | 25 | 4 | 100 | 0.161 | 16.24 | 204x204x146 | 428x214x312 |
| | 51x100 | 40 | 1 | 40 | 0.278 | 11.83 | 515x337x210 | 515x337x210 |
| | 51x120 | 40 | 1 | 40 | 0.326 | 13.75 | | |
| | 51x170 | 36 | 1 | 36 | 0.412 | 15.76 | 515x337x260 | 515x337x260 |
| | 64x120 | 24 | 1 | 24 | 0.485 | 12.35 | 515x337x210 | 515x337x210 |
| | 64x140 | 20 | 1 | 20 | 0.558 | 12.09 | 515x337x260 | 515x337x260 |
| | 64x170 | 20 | 1 | 20 | 0.775 | 16.43 | 515x337x310 | 515x337x310 |
| | 64x195 | 16 | 1 | 16 | 0.51 | 9.31 | | |
| | 76x140 | 12 | 1 | 12 | 0.714 | 9.5 | 515x337x260 | 515x337x260 |
| | 76x150 | 12 | 1 | 12 | 0.603 | 8.17 | | |
| | 76x170 | 12 | 1 | 12 | 1.012 | 13.07 | | |
| | 76x190 | 9 | 1 | 9 | 1.209 | 12.03 | 515x337x310 | 515x337x310 |
| | 76x220 | 9 | 1 | 9 | 1.472 | 14.39 | 515x337x260 | 515x337x260 |
| | 90x170 | 12 | 1 | 12 | 1.237 | 15.77 | | |
| 90x190 | 7 | 1 | 7 | 1.635 | 12.59 | | | |
| Snap-In, LUG | 20x50 | 200 | 4 | 800 | 0.022 | 4.61 | 272 x 272 x 146 | 564 x 282 x312 |
| | 22x25 | 300 | 4 | 1200 | 0.013 | 4.11 | | |
| | 22x30 | 300 | 4 | 1200 | 0.016 | 5.01 | | |
| | 22x35 | 200 | 4 | 800 | 0.02 | 4.21 | | |
| | 22x40 | 200 | 4 | 800 | 0.022 | 4.61 | | |
| | 22x45 | 200 | 4 | 800 | 0.023 | 4.81 | | |
| | 22x50 | 200 | 4 | 800 | 0.03 | 6.21 | | |
| | 25x25 | 300 | 4 | 1200 | 0.016 | 5.05 | 302 x 302 x 146 | 624 x 312 x 312 |
| | 25x30 | 300 | 4 | 1200 | 0.017 | 5.35 | | |
| | 25x35 | 300 | 4 | 1200 | 0.022 | 6.85 | | |
| | 25x40 | 200 | 4 | 800 | 0.028 | 5.85 | | |
| | 25x45 | 200 | 4 | 800 | 0.032 | 6.65 | | |
| | 25x50 | 200 | 4 | 800 | 0.035 | 7.25 | | |
| | 30x25 | 75 | 4 | 300 | 0.024 | 1.92 | | |
| | 30x30 | 75 | 4 | 300 | 0.027 | 2.15 | | |
| | 30x35 | 75 | 4 | 300 | 0.036 | 2.82 | | |
| | 30x40 | 50 | 4 | 200 | 0.04 | 2.12 | | |
| | 30x45 | 50 | 4 | 200 | 0.045 | 2.37 | | |
| | 30x50 | 50 | 4 | 200 | 0.05 | 2.62 | | |
| | 30x55 | 50 | 4 | 200 | 0.055 | 2.87 | | |
| 35x30 | 75 | 4 | 300 | 0.036 | 2.87 | 204 x 204 x 146 | 428 x 214 x 312 | |
| 35x35 | 75 | 4 | 300 | 0.039 | 3.06 | | | |
| 35x40 | 50 | 4 | 200 | 0.046 | 2.44 | | | |
| 35x50 | 50 | 4 | 200 | 0.061 | 3.19 | | | |

Marking Specifications

| Month | Jan | Feb | Mar | Apr | May | Jun | Jul | Aug | Sep | Oct | Nov | Dec |
|-------|-----|-----|-----|-----|-----|-----|-----|-----|-----|-----|-----|-----|
| Code | 1 | 2 | 3 | 4 | 5 | 6 | 7 | 8 | 9 | O | N | D |

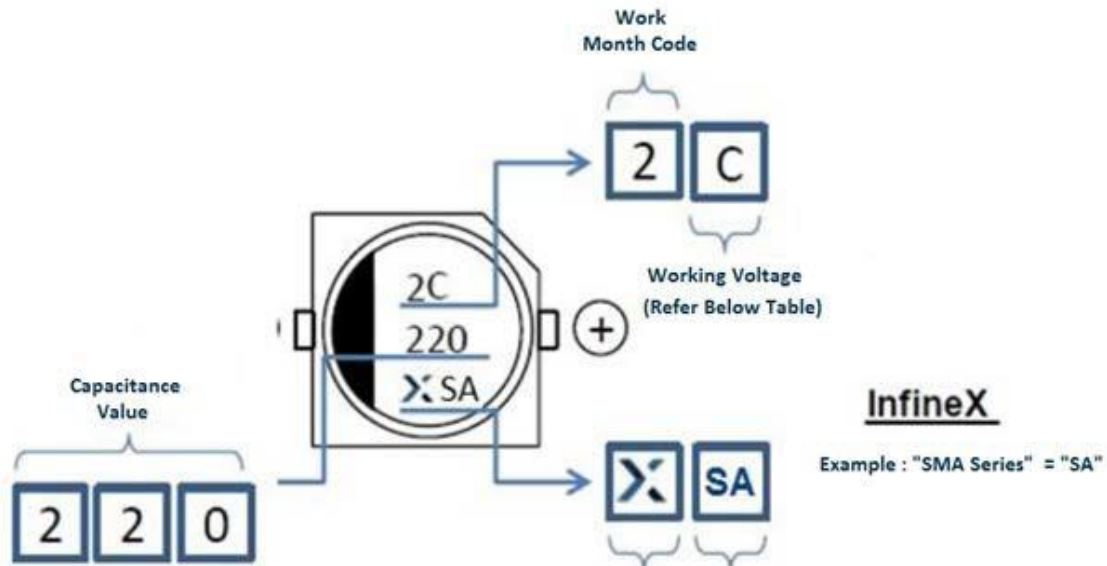

Example: 2.2uF = 2.2, 22uF = 22, 220uF = 220, 2200uF = 2200 * Logo Series Name

* Only for Outer Diameter > 5mm

| | | | | | | | | | | | |
|-----------------|-----|-----|-----|-----|-----|-----|-----|-----|-----|----|----|
| Working Voltage | 2.5 | 4 | 6.3 | 10 | 16 | 20 | 25 | 35 | 50 | 63 | 80 |
| Code | Z | A | B | C | D | Q | E | F | G | H | J |
| Working Voltage | 100 | 125 | 160 | 200 | 250 | 350 | 400 | 450 | 500 | | |
| Code | I | O | K | M | N | P | L | R | S | | |

Aluminum Electrolytic Capacitor

| | | | | | | | |
|----------------|-----|-----|-----|-----|-----|-----|-----|
| INFINEX Series | SMA | SMB | SMC | SMD | SME | SMF | SMG |
| Series Code | SA | SB | SC | SD | SE | SF | SG |

Conductive Polymer Aluminum Solid Capacitors

| | | | | | | | | | | | |
|----------------|-----|-----|-----|-----|-----|-----|-----|-----|-----|-----|-----|
| INFINEX Series | PSA | PSB | PSC | PSD | PSE | PRA | PRB | PRC | PRD | PRE | PRF |
| Series Code | PA | PB | PC | PD | PE | P1 | P2 | P3 | P4 | P5 | P6 |

Conductive Polymer Hybrid Aluminum Electrolytic Capacitors

| | | | | |
|----------------|-----|-----|-----|-----|
| INFINEX Series | HSA | HSB | HRA | HRB |
| Series Code | HA | HB | H1 | H2 |

Dip Type

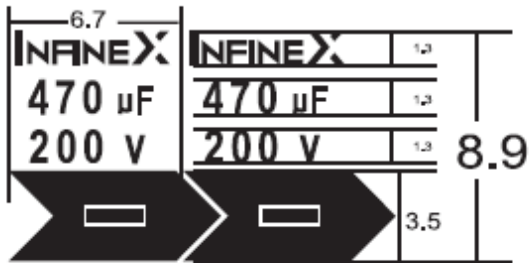
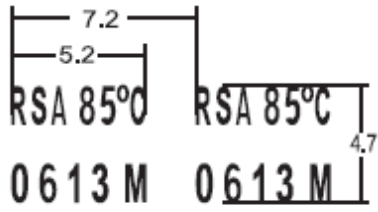

Sales and Support

Infinex Headquarters
12455-G Research Blvd.
Austin, TX USA 78759

sales@infinex.com

engineering@infinex.com

Infinex, a Flex company (including its affiliates, employees, agents and other persons acting on Infinex's behalf), reserve the right to make modifications, improvements, corrections or other changes without further notice to any product herein. The product information is provided only for reference purposes and Infinex does not assume any liability arising out of an application or use of any product described herein and disclaims any warranties expressed or implied; neither does it convey any license under its patent rights, nor the right of others. The user of products in such applications shall assume all risks of such use and will agree to hold Infinex, and all the companies whose products are represented on our website, harmless against all damages.

© 2023 Infinex, a Flex company. All rights reserved. Infinex and the Infinex logo are trademarks of Infinex. No part of this document can be reproduced in any form without the written permission of Infinex.

Document Revision Number:3.0, 06/26/2023

Infinex, a Flex company, is a global electronic components manufacturer that provides cost-effective, simplified supply chain solutions. Specializing in high-quality passive and frequency management components, antennas, semiconductors, interconnect cables and connectors, Infinex core electronic technologies enable design innovation in a broad range of end-use applications in every industry. By combining a differentiated, highly responsive supply chain with a global footprint, Infinex serves its customers everywhere they require. Recognized for global operational excellence and trusted strategic partnerships, Infinex empowers customers to improve efficiencies, speed time to market and build a significant competitive advantage that lasts. Learn more at [infinex.com](https://www.infinex.com).

For more information, visit
[infinex.com](https://www.infinex.com)