

# IXSCA Series

## Super capacitor



Lithium Ion Type



Cylindrical Type



Combined Type

### ❖ Features

#### For Lithium-Ion Type

- Lithium ion capacitor is a new type of energy storage element which combines the high power density of double layer capacitor and the high energy density of lithium ion battery, the application prospect is broad.
- Wide operating temperature range -40°C rechargeable, 85°C available for discharge.
- Green, meet RoHs requirements

#### For Standard Cylindrical Type / Low ESR Cylindrical Type /High Voltage Cylindrical Type / High Temperature Cylindrical Type / Standard Combined Type / High Voltage Combined Type / High Temperature Combined Type

- Low internal resistance and high power density
- Self-discharge rate is small, 72 hours self-discharge<20%
- Excellent cycle life, the coulomb efficiency is more than 95%
- Wide operating temperature ranges
- Green, meet RoHS requirements

### ❖ Application

#### For Lithium Ion Type

- Intelligent Instrument, Automobile Data Recorder, Illumination Lamp
- ETC, Fiscal Cash Register, Digital Camera, Power Tools
- Wireless Energy Saving Mouse, Wireless Handwriting Board, SSD Solid State Drive

#### For Standard Cylindrical Type / Low ESR Cylindrical Type /High Voltage Cylindrical Type / High Temperature Cylindrical Type / Standard Combined Type / High Voltage Combined Type /High Temperature Combined Type

- Intelligent instrument, automobile data recorder, illumination lamp
- Fiscal cash register, digital camera, power tools
- Wireless energy saving mouse, wireless handwriting board, SSD solid state drive

### ❖ Part Numbering

IXSCA	M	2V7	104	M	V	-1
Type	Shape Type	Rated Voltage	Capacitance	Tolerance	Series Code	Internal code
	M: Lithium-Ion Type L: Cylindrical & Radial Type Z: Combined Type	2V7: 2.7V 3V0: 3.0V 3V6: 3.6V 3V8: 3.8V 5V5: 5.5V 6V0: 6.0V	104: 0.1F 105: 1F 106: 10F	M: ±20% Z: +80/-20% 9: +30/-10%	: Standard LR: Low ESR V: High Voltage H: High Temperature	: Standard -1: Custom

## ❖ Lithium Ion Type Supercapacitor

### Specifications

Performance	Performance Characteristics	Notes
Capacitance Range	20~120F	$I=5 \times C_{RX}(U_R-U_{min})/3.6$ (mA)
Capacitance Tolerance	+80/-20%	@25°C
Operating Voltage Range	3.8V	DC
Mix Voltage	2.5V	
Operating Temperature Range	-20°C~+65°C	

### Specifications Value of Standard Product

Part No.	Rated Voltage DC (V)	Capacitance		MAX ESR AC,1KHz,3.8V (mΩ)	Max charge current @4.0 V ( mA )	Discharge	
		(F)	25°C (mAh)			Maximum Continuous Discharge Current (mA)	Pulse (1 sec) (A)
IXSCAM3V8206Z	3.8	20	7.5	500	200	100	0.5
IXSCAM3V8406Z	3.8	40	15	200	300	200	1.0
IXSCAM3V8706Z	3.8	70	30	175	500	250	3.0
IXSCAM3V8806Z	3.8	80	28	150	560	300	3.0

Body color : Green

### Dimensions

Part No.	D (mm)	L (mm)	P (mm)	d (mm)
IXSCAM3V8206Z	8±1.5	13±1.5	3.5±0.5	0.6±0.1
IXSCAM3V8406Z	8±1.5	20±1.5	3.5±0.5	0.6±0.1
IXSCAM3V8706Z	12.5±1.5	13±1.5	5.0±0.5	0.6±0.1
IXSCAM3V8806Z	10±1.5	20±1.5	5.0±0.5	0.6±0.1

### Outline and Dimensions

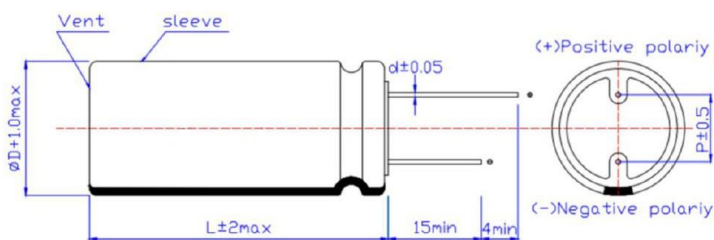

The actual size and tolerance shall be subject to the parameter table.

### Packaging Quantity

Part No.	Quantity (EA)
	Plastic Tray
IXSCAM3V8206Z	50
IXSCAM3V8406Z	50
IXSCAM3V8706Z	40
IXSCAM3V8806Z	40

## ❖ Environmental Characteristics

Item	Requirement		Test Condition
Optimum	-10 ~ 50°C, ≤ ±65%RH		
Characteristics in different temperature	Step 2	ΔC	20F: Less than or equal to 50% of the initial value 40F/70F/80F/120F: Less than or equal to 30% of the initial value
		ESR	Less than or equal to 1000% of the specified value
	Step 3	ΔC	Less than or equal to 30% of the initial value
		ESR	Less than or equal to 200% of the specified value
	Step 4	ΔC	Satisfies the range of 20% of the initial rating
		ESR	Satisfies the initial value
Endurance	ΔC	Satisfies the range of 30% of the initial value	Temperature. +65°C±2°C (20F); +55±2°C (40F/70F/80F/120F) Time. 1000h
	ESR	Less than or equal to 400% of the specified value	
	Appearance	No leakage or mechanical damage	
Cycle life	ΔC	Satisfies the range of 30% of the initial value	3.1V ~ 3.7V 20F: 75mA 40F: 150mA 70F: 250mA 80F: 280mA 120F: 450mA Temperature. +25°C±2°C Cycles. 100000
	ESR	Less than or equal to 400% of the specified value	
Forced Discharge	No fire No explosion		Recharge the Asymmetry Super Capacitor by standard charge, discharge at a current of 75mA(20F)/200mA(40F)/250mA(70F)/300mA(80F)/500mA(120F) for 2.5h.
Vibration Test	No leakage No fire		After standard charging, fixed the cell to vibration table and subjected to vibration cycling that the frequency is to be varied at the rate of 1 Hz per minute between 10Hz ~ 55Hz, the excursion of the vibration is 1.6mm. The cell shall be vibrated for 30 minutes per axis of XYZ axes.
Drop	No leakage No fire No burst or explosion		After standard charging. Drop the product from the height of 1.0m to a hardwood of 20mm thick, and fall down the X,Y,Z respectively for one time.
Impact	No fire No explosion Allows for deformation		Place the product on the impact table, with a diameter of 15.8mm. the 10-kilogram weight of the weight is freely falling from 1m, and the impact has been fixed in the fixture.
Low Temperature	No fire No explosion 20F: The discharge capacity is more than 50% of the initial capacity. 40F/70F/80F/120F: The discharge capacity is more than 70% of the initial capacity.		Recharge the Asymmetry Super Capacitor by standard charge, Place the cell in low temperature -40°C (20F) / -20°C(40F/70F/80F/120F), 4h. environment,Then 75mA(20F)/200mA(40F)/250mA(70F)/300mA(80F)/500mA(120F) is then discharged to 3.0V

## ❖ Standard Cylindrical Type Supercapacitor

### Specifications

Performance	Performance Characteristics	Notes
Capacitance Range	0.5~400F	$I=8*CU_R(\text{mA})$
Capacitance Tolerance	±20%	@25°C
Rated Voltage	2.7V	DC
Operating Temperature Range	-40°C~+70°C	

### Specifications Value of Standard Product: Cylindrical & Radial Type

Part No.	Rated Voltage (V)	Rated Capacitance (F)	Max. ESR DC 25°C (mΩ)	Nominal Current (25°C, A)	Maximum Peak Current (25°C<1s, A)	Leakage Current (25°C 72h, mA)	Store energy (mWh)	Energy density (Wh/kg)	Power density (kW/kg)
IXSCAL2V7504M	2.7	0.5	500	0.13	0.54	0.010	0.51	0.72	2.60
IXSCAL2V7105M	2.7	1	350	0.25	1.00	0.010	1.01	1.58	4.07
IXSCAL2V7105M-1	2.7	1	350	0.25	1.00	0.010	1.01	1.13	2.89
IXSCAL2V7205M	2.7	2	180	0.50	1.99	0.010	2.03	1.70	4.25
IXSCAL2V7305M	2.7	3	120	0.76	2.98	0.010	3.04	2.34	5.84
IXSCAL2V7335M	2.7	3.3	120	0.83	3.19	0.010	3.34	2.39	5.42
IXSCAL2V7505M	2.7	5	80	1.25	4.82	0.020	5.06	2.38	7.59
IXSCAL2V7505M-1	2.7	5	75	1.26	4.91	0.020	5.06	2.88	6.90
IXSCAL2V7605M	2.7	6	75	1.49	5.59	0.020	6.08	3.16	6.33
IXSCAL2V7705M	2.7	7	70	1.72	6.34	0.030	7.09	3.30	6.05
IXSCAL2V7106M	2.7	10	65	2.39	8.18	0.030	10.13	3.92	5.43
IXSCAL2V7156M	2.7	15	55	3.48	11.10	0.050	15.19	4.11	4.49
IXSCAL2V7206M	2.7	20	45	4.58	14.21	0.060	20.25	6.53	6.53
IXSCAL2V7256M	2.7	25	30	5.87	19.29	0.070	25.31	4.14	4.97
IXSCAL2V7306M	2.7	30	30	6.86	21.32	0.078	30.38	4.29	4.29
IXSCAL2V7506M	2.7	50	25	10.80	30.00	0.100	50.63	4.71	3.39
IXSCAL2V7606M	2.7	60	25	12.46	32.40	0.120	60.75	4.87	2.92

Nominal Current Is the current taking 5 sec. to discharge from  $U_R$  to  $1/2U_R$ .

Maximum Peak Current Is the current taking 1 sec. to discharge from  $U_R$  to  $1/2U_R$

Body color : Blue

### Outline and Dimensions

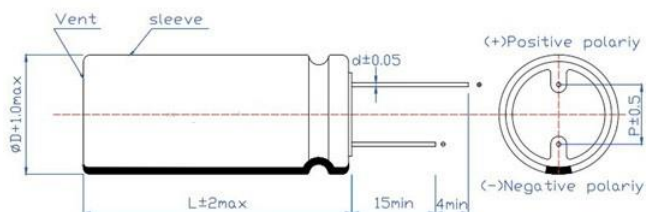

The actual size and tolerance shall be subject to the parameter table.

## Dimensions

Part No.	D (mm)	L (mm)	P (mm)	d (mm)
IXSCAL2V7504M	6.3±1.0	12.5±1.5	2.5±0.5	0.5±0.05
IXSCAL2V7105M	6.3±1.0	12.5±1.5	2.5±0.5	0.5±0.05
IXSCAL2V7105M-1	8.0±1.0	13.0±1.5	3.5±0.5	0.6±0.05
IXSCAL2V7205M	8.0±1.0	16.0±1.5	3.5±0.5	0.6±0.05
IXSCAL2V7305M	8.0±1.0	20.0±1.5	3.5±0.5	0.6±0.05
IXSCAL2V7335M	8.0±1.0	20.0±1.5	3.5±0.5	0.6±0.05
IXSCAL2V7505M	8.0±1.0	24.0±1.5	3.5±0.5	0.6±0.05
IXSCAL2V7505M-1	10.0±1.0	20.0±1.5	5.0±0.5	0.6±0.05
IXSCAL2V7605M	10.0±1.0	20.0±1.5	5.0±0.5	0.6±0.05
IXSCAL2V7705M	10.0±1.0	20.0±1.5	5.0±0.5	0.6±0.05
IXSCAL2V7106M	10.0±1.0	25.0±2.0	5.0±0.5	0.6±0.05
IXSCAL2V7156M	12.5±1.0	25.0±2.0	5.0±0.5	0.6±0.05
IXSCAL2V7206M	12.5±1.0	25.0±2.0	5.0±0.5	0.6±0.05
IXSCAL2V7256M	16.0±1.0	25.0±2.0	7.5±0.5	0.8±0.05
IXSCAL2V7306M	16.0±1.0	30.0±2.0	7.5±0.5	0.8±0.05
IXSCAL2V7506M	18.0±1.0	40.0±2.0	7.5±0.5	0.8±0.05
IXSCAL2V7606M	18.0±1.0	40.0±2.0	7.5±0.5	0.8±0.05

## Packaging Quantity

Part No.	Quantity (EA)
	Plastic Bag
IXSCAL2V7504M	2000
IXSCAL2V7105M	2000
IXSCAL2V7105M-1	1500
IXSCAL2V7205M	1000
IXSCAL2V7305M	1000
IXSCAL2V7335M	1000
IXSCAL2V7505M	1000
IXSCAL2V7505M-1	800
IXSCAL2V7605M	800
IXSCAL2V7705M	800
IXSCAL2V7106M	600
IXSCAL2V7156M	400
IXSCAL2V7206M	400
IXSCAL2V7256M	250
IXSCAL2V7306M	200
IXSCAL2V7506M	80
IXSCAL2V7606M	80

## ❖ Environmental Characteristics

Item	Requirement		Test Condition	
Characteristics in different temperature	Step 2	△C	Less than or equal to 30% of the initial value	Step 1: +25°C±2°C Step 2: -25°C±2°C Step 3: +70°C±2°C Step 4: +25°C±2°C
		ESR	Less than or equal to 400% of the initial value	
	Step 3	△C	Less than or equal to 30% of the initial value	
		ESR	Less than or equal to the initial value	
	Step 4	△C	Satisfies the range of 20% of the initial rating	
		ESR	Satisfies the initial value	
Endurance	△C	Less than or equal to 30% of the initial value	Applied voltage : Rated voltage Temperature : Upper limit temperature Time : 1000h	
	ESR	Less than or equal to 4 times the initial value		
	Appearance	No leakage or mechanical damage		
Cycle life	△C	Less than or equal to 30% of the initial value	At 25°C, charge to the rated voltage with constant current, stand for 5s, discharge to 50% voltage with constant current, stand for 5s, cycle 100000	
	Appearance	Less than or equal to 3 times the initial value		
Humidity Characteristics	△C	Satisfies the range of 30% of the initial rating	Temperature: +40°C±2°C Relative humidity: 90~95%RH Test time: 240h	
	ESR	Less than or equal to 4 times the initial value		
	Appearance	No leakage or mechanical damage		
Temperature cycle	△C	Less than or equal to 10% of the initial value	Temperature cycle : Lower limit temperature → normal temperature → Upper limit temperature → normal temperature Cycles : 5	
	Appearance	No mechanical damage or leakage		
Low temperature storage characteristics	△C	Satisfies the range of 10% of the initial rating	Applied voltage : 0V Temperature : Lower limit temperature Time : 96h	
	ESR	Less than or equal to 2 times the initial value		
	Appearance	No leakage or mechanical damage		
High temperature storage characteristics	△C	Satisfies the range of 10% of the initial rating	Applied voltage : 0V Temperature : Upper limit temperature Time : 96h	
	ESR	Less than or equal to 2 times the initial value		
	Appearance	No leakage or mechanical damage		
Self discharge characteristics (voltage holding characteristics)	Voltage between positive and negative poles ≥ 80%U <sub>R</sub>		Charging process: normal temperature, no load, rated voltage charge 24h Placement process: temperature less than or equal to 25 °C, relative humidity less than 60% RH, open 24 h	
Lead strength	No damage to the outlet			
Solder ability	More than 3/4 of the terminal surface is covered by a tin layer			

**Storage Temperature: -30~50°C; Relative Humidity:<60%RH, Max. Humidity<85%RH**

**Citation standards:IEC62391-1 &DL T 1652-2016**

## ❖ Low ESR Cylindrical Type Supercapacitor

### Specifications

Performance	Performance Characteristics	Notes
Capacitance Range	0.5~400F	$I=8*CU_R(\text{mA})$
Capacitance Tolerance	±20%	@25°C
Rated Voltage	2.7V	DC
Operating Temperature Range	-40°C~+70°C	

### Specifications Value of Product: Cylindrical & Radial Type

Part No.	Rated Voltage (V)	Capacitance (F)	Max. ESR DC 25°C (mΩ)	Nominal Current (25°C, A)	Maximum Peak Current (25°C<1s, A)	Leakage Current (25°C72h, mA)	Store energy (mWh)	Energy density (Wh/kg)	Power density (kW/kg)
IXSCAL2V7504MLR	2.7	0.5	280	0.13	0.59	0.013	0.51	0.72	4.65
IXSCAL2V7105MLR	2.7	1	240	0.26	1.09	0.016	1.01	1.58	5.93
IXSCAL2V7105MLR-1	2.7	1	200	0.26	1.13	0.016	1.01	0.99	4.47
IXSCAL2V7205MLR	2.7	2	140	0.51	2.11	0.018	2.03	0.96	3.10
IXSCAL2V7335MLR	2.7	3.3	80	0.85	3.52	0.021	3.34	1.57	5.35
IXSCAL2V7505MLR	2.7	5	60	1.27	5.19	0.030	5.06	1.43	4.29
IXSCAL2V7505MLR-1	2.7	5	60	1.27	5.19	0.030	5.06	1.00	3.00
IXSCAL2V7605MLR	2.7	6	55	1.52	6.09	0.036	6.08	1.20	3.27
IXSCAL2V7705MLR	2.7	7	50	1.77	7.00	0.042	7.09	1.14	2.93
IXSCAL2V7106MLR	2.7	10	45	2.48	9.31	0.050	10.13	1.00	2.00

**Nominal Current** . Is the current taking 5 sec. to discharge from  $U_R$  to  $1/2U_R$ .

**Maximum Peak Current** . Is the current taking 1 sec. to discharge from  $U_R$  to  $1/2U_R$

**Body color** : Blue

### Outline and Dimensions

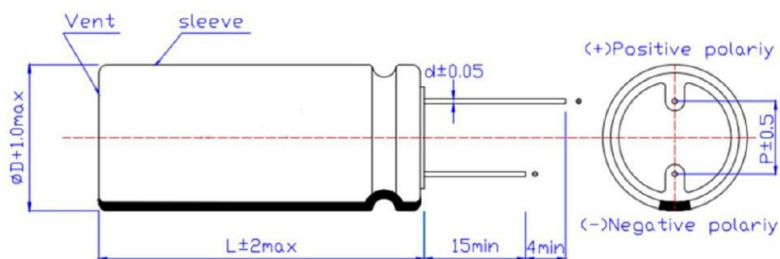

### Dimensions

Part No.	D (mm)	L (mm)	P (mm)	d (mm)
IXSCAL2V7504MLR	6.3±1.0	12.5±1.5	2.5±0.5	0.5±0.05
IXSCAL2V7105MLR	6.3±1.0	12.5±1.5	2.5±0.5	0.5±0.05
IXSCAL2V7105MLR-1	8±1.0	13±1.5	3.5±0.5	0.6±0.05
IXSCAL2V7205MLR	8±1.0	20±1.5	3.5±0.5	0.6±0.05
IXSCAL2V7335MLR	8±1.0	20±1.5	3.5±0.5	0.6±0.05
IXSCAL2V7505MLR	8±1.0	24±1.5	3.5±0.5	0.6±0.05
IXSCAL2V7505MLR-1	10±1.0	20±1.5	5.0±0.5	0.6±0.05
IXSCAL2V7605MLR	10±1.0	20±1.5	5.0±0.5	0.6±0.05
IXSCAL2V7705MLR	10±1.0	20±1.5	5.0±0.5	0.6±0.05
IXSCAL2V7106MLR	10±1.0	25±2.0	5.0±0.5	0.6±0.05

### Packaging Quantity

Part No.	Quantity (EA)
	Plastic Bag
IXSCAL2V7504MLR	2000
IXSCAL2V7105MLR	2000
IXSCAL2V7105MLR-1	1500
IXSCAL2V7205MLR	1000
IXSCAL2V7335MLR	1000
IXSCAL2V7505MLR	1000
IXSCAL2V7505MLR-1	800
IXSCAL2V7605MLR	800
IXSCAL2V7705MLR	800
IXSCAL2V7106MLR	600



## ❖ Environmental Characteristics

Item	Requirement		Test Condition	
Characteristics in different temperature	Step 2	△C	Less than or equal to 30% of the initial value	Step 1: +25°C±2°C Step 2: -25°C±2°C Step 3: +70°C±2°C Step 4: +25°C±2°C
		ESR	Less than or equal to 400% of the initial value	
	Step 3	△C	Less than or equal to 30% of the initial value	
		ESR	Less than or equal to the initial value	
	Step 4	△C	Satisfies the range of 20% of the initial rating	
		ESR	Satisfies the initial value	
Endurance	△C	Less than or equal to 30% of the initial value	Applied voltage : Rated voltage Temperature : Upper limit temperature Time : 1000h	
	ESR	Less than or equal to 4 times the initial value		
	Appearance	No leakage or mechanical damage		
Cycle life	△C	Less than or equal to 30% of the initial value	At 25°C, charge to the rated voltage with constant current, stand for 5s, discharge to 50% voltage with constant current, stand for 5s, cycle 100000.	
	ESR	Less than or equal to 3 times the initial value		
Humidity Characteristics	△C	Satisfies the range of 30% of the initial rating	Temperature: +40°C±2°C Relative humidity: 90~95%RH Test time: 240h	
	ESR	Less than or equal to 4 times the initial value		
	Appearance	No leakage or mechanical damage		
Temperature cycle	△C	Less than or equal to 10% of the initial value	Temperature cycle : Lower limit temperature → normal temperature → Upper limit temperature → normal temperature Cycles : 5	
	Appearance	No mechanical damage or leakage		
Low temperature storage characteristics	△C	Satisfies the range of 10% of the initial rating	Applied voltage : 0V Temperature : Lower limit temperature Time : 96h	
	ESR	Less than or equal to 2 times the initial value		
	Appearance	No leakage or mechanical damage		
High temperature storage characteristics	△C	Satisfies the range of 10% of the initial rating	Applied voltage : 0V Temperature : Upper limit temperature Time : 96h	
	ESR	Less than or equal to 2 times the initial value		
	Appearance	No leakage or mechanical damage		
Self discharge characteristics (voltage holding characteristics)	Voltage between positive and negative poles ≥ 80%U <sub>R</sub>		Charging process: normal temperature, no load, rated voltage charge 24h Placement process: temperature less than or equal to 25 °C, relative humidity less than 60% RH, open 24 h	
Lead strength	No damage to the outlet			
Solder ability	More than 3/4 of the terminal surface is covered by a tin layer			

**Storage Temperature: -30~50°C, Relative Humidity:<60%RH, Max. Humidity<85%RH**

**Citation standards: IEC62391-1 & DL T 1652-2016**

## ❖ High Voltage Cylindrical Type Supercapacitor

### Specifications

Performance	Performance Characteristics	Notes
Capacitance Range	1~100F	$I=8*CU_R(\text{mA})$
Capacitance Tolerance	$\pm 20\%$ , $+30\%/-10\%$	@25°C
Rated Voltage	3.0V	DC
Operating Temperature Range	-40°C~+70°C	

### Specifications Value of Product

Part No.	Rated Voltage (V)	Capacitance (F)	Max. ESR DC 25°C (mΩ)	Nominal Current (25°C, A)	Maximum Peak Current (25°C<1s, A)	Leakage Current (25°C72h, mA)	Store energy (mWh)	Energy density (Wh/kg)	Power Densitk (W/kg)
IXSCAL3V0105MV	3.0	1	350	0.28	1.11	0.008	1.25	1.37	3.53
IXSCAL3V0305MV	3.0	3	120	0.84	3.31	0.013	3.75	2.82	4.05
IXSCAL3V0335MV	3.0	3.3	120	0.92	3.55	0.013	4.13	1.77	4.02
IXSCAL3V0505MV	3.0	5	80	1.39	5.36	0.016	6.25	4.40	9.90
IXSCAL3V0505MV-1	3.0	5	75	1.40	5.45	0.016	6.25	4.03	9.68
IXSCAL3V0605MV	3.0	6	75	1.65	6.21	0.024	7.50	4.21	8.43
IXSCAL3V06059V	3.0	6	75	1.65	6.21	0.024	7.50	4.21	8.43
IXSCAL3V0106MV	3.0	10	65	2.65	9.09	0.032	12.50	5.71	7.90
IXSCAL3V0156MV	3.0	15	55	3.86	12.33	0.052	18.75	7.08	7.72
IXSCAL3V0256MV	3.0	25	30	6.52	21.43	0.075	31.25	5.04	6.05
IXSCAL3V02569V	3.0	25	30	6.52	21.43	0.075	31.25	5.04	6.05
IXSCAL3V0306MV	3.0	30	30	7.63	23.68	0.075	37.50	5.15	5.15
IXSCAL3V0606MV	3.0	60	25	13.85	36.00	0.120	75.00	5.67	3.40
IXSCAL3V0107MV	3.0	100	18	22.06	53.57	0.300	125.00	7.33	3.66

**Nominal Current** . Is the current taking 5 sec. to discharge from  $U_R$  to  $1/2U_R$ .

**Maximum Peak Current** . Is the current taking 1 sec. to discharge from  $U_R$  to  $1/2U_R$

Body color : Blue

### Outline and Dimensions

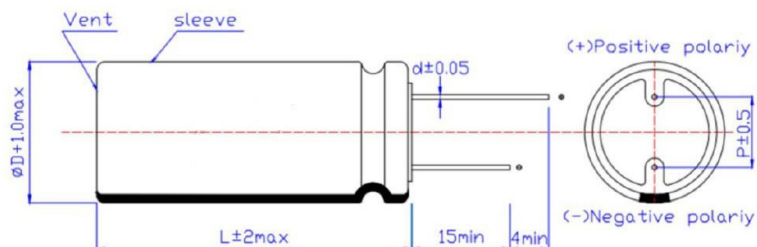

The actual size and tolerance shall be subject to the parameter table.

### Dimensions

Part No.	D (mm)	L (mm)	P (mm)	d (mm)
IXSCAL3V0105MV	8±1.0	13±1.5	3.5±0.5	0.6±0.05
IXSCAL3V0305MV	8±1.0	20±1.5	3.5±0.5	0.6±0.05
IXSCAL3V0335MV	8±1.0	20±1.5	3.5±0.5	0.6±0.05
IXSCAL3V0505MV	8±1.0	24±1.0	3.5±0.5	0.6±0.05
IXSCAL3V0505MV-1	10±1.0	20±1.5	5.0±0.5	0.6±0.05
IXSCAL3V0605MV	10±1.0	20±1.5	5.0±0.5	0.6±0.05
IXSCAL3V06059V	10±1.0	20±1.5	5.0±0.5	0.6±0.05
IXSCAL3V0106MV	10±1.0	25±2.0	5.0±0.5	0.6±0.05
IXSCAL3V0156MV	12.5±1.0	25±2.0	5.0±0.5	0.6±0.05
IXSCAL3V0256MV	16±1.0	25±2.0	7.5±0.5	0.8±0.05
IXSCAL3V02569V	16±1.0	25±2.0	7.5±0.5	0.8±0.05
IXSCAL3V0306MV	16±1.0	30±2.0	7.5±0.5	0.8±0.05
IXSCAL3V0606MV	18±1.0	42±2.0	7.5±0.5	0.8±0.05
IXSCAL3V0107MV	18±1.0	60±2.0	7.5±0.5	0.8±0.05

### Packaging Quantity

Part No.	Quantity(EA)
	Plastic Bag
IXSCAL3V0105MV	1500
IXSCAL3V0305MV	1000
IXSCAL3V0335MV	1000
IXSCAL3V0505MV	1000
IXSCAL3V0505MV-1	800
IXSCAL3V0605MV	800
IXSCAL3V06059V	800
IXSCAL3V0106MV	600
IXSCAL3V0156MV	400
IXSCAL3V0256MV	250
IXSCAL3V02569V	250
IXSCAL3V0306MV	200
IXSCAL3V0606MV	80
IXSCAL3V0107MV	50

## ❖ Environmental Characteristics

Item	Requirement		Test Condition	
Characteristics in different temperature	Step 2	ΔC	Less than or equal to 30% of the initial value	Step 1: +25°C±2°C Step 2: -25°C±2°C Step 3: +70°C±2°C Step 4: +25°C±2°C
		ESR	Less than or equal to 400% of the initial value	
	Step 3	ΔC	Less than or equal to 30% of the initial value	
		ESR	Less than or equal to the initial value	
	Step 4	ΔC	Satisfies the range of 20% of the initial rating	
		ESR	Satisfies the initial value	
Endurance	ΔC	Less than or equal to 30% of the initial value	Applied voltage : Rated voltage Temperature : Upper limit temperature Time : 1000h	
	ESR	Less than or equal to 4 times the initial value		
	Appearance	No leakage or mechanical damage		
Cycle life	ΔC	Less than or equal to 30% of the initial value	At 25°C, charge to the rated voltage with constant current, stand for 5s, discharge to 50% voltage with constant current, stand for 5s, cycle 100000	
	ESR	Less than or equal to 3 times the initial value		
Humidity Characteristics	ΔC	Less than or equal to 30% of the initial value	Temperature: +40°C±2°C Relative humidity: 90~95%RH Test time: 240h	
	ESR	Less than or equal to 4 times the initial value		
	Appearance	No leakage or mechanical damage		
Temperature cycle	ΔC	Less than or equal to 10% of the initial value	Temperature cycle : Lower limit temperature →normal temperature →Upper limit temperature →normal temperature Cycles : 5	
	Appearance	No leakage or mechanical damage		
Low temperature storage characteristics	ΔC	Satisfies the range of 10% of the initial rating	Applied voltage : 0V Temperature : Lower limit temperature Time : 96h	
	ESR	Less than or equal to 2 times the initial value		
	Appearance	No leakage or mechanical damage		
High temperature storage characteristics	ΔC	Satisfies the range of 10% of the initial rating	Applied voltage : 0V Temperature : Upper limit temperature Time : 96h	
	ESR	Less than or equal to 2 times the initial value		
	Appearance	No leakage or mechanical damage		
Self discharge characteristics (voltage holding characteristics)	Voltage between positive and negative poles≥80%U <sub>R</sub>		Charging process: normal temperature, no load, rated voltage charge24h Placement process: temperature less than or equal to 25 °C, relative humidity less than 60% RH, open 24 h	
Lead strength	No damage to the outlet			
Solder ability	More than 3/4 of the terminal surface is covered by a tin layer			

**Storage Temperature: -30~50°C; Relative Humidity:<60%RH, Max. Humidity<85%RH**

**Citation standards: IEC62391-1 &DL T 1652-2016**

## ❖ High Temperature Cylindrical Type Supercapacitor

### Specifications

Performance	Performance Characteristics	Notes
Capacitance Range	0.5~25F	$I=8*CU_R$ (mA)
Capacitance Tolerance	±20%	@25°C
Rated Voltage	2.7V	DC
Operating Temperature Range	-40°C~+85°C	

### Specifications Value of Product

Part No.	Rated Voltage (V)	Capacitance (F)	Max. ESR DC 25°C (mΩ)	Nominal Current (25°C, A)	Maximum Peak Current (25°C<1s, A)	Leakage Current (25°C72h, mA)	Store energy (mWh)	Energy density (Wh/kg)	Power density (kW/kg)
IXSCAL2V7504MH	2.7	0.5	500	0.13	0.54	0.008	0.51	1.13	4.05
IXSCAL2V7105MH	2.7	1	350	0.25	1.00	0.008	1.01	1.14	2.93
IXSCAL2V7205MH	2.7	2	180	0.50	1.99	0.012	2.03	1.67	4.18
IXSCAL2V7205MH-1	2.7	2	260	0.49	1.78	0.013	2.03	1.81	3.13
IXSCAL2V7305MH	2.7	3	120	0.76	2.98	0.013	3.04	2.27	5.67
IXSCAL2V7335MH	2.7	3.3	120	0.83	3.19	0.015	3.34	1.45	3.29
IXSCAL2V7505MH	2.7	5	80	1.25	4.82	0.016	5.06	3.54	6.97
IXSCAL2V7605MH	2.7	6	75	1.25	4.91	0.016	6.08	3.51	7.02
IXSCAL2V7705MH	2.7	7	70	1.72	6.34	0.028	7.09	3.83	7.04
IXSCAL2V7106MH	2.7	10	65	2.39	8.18	0.030	20.25	5.77	5.77
IXSCAL2V7256MH	2.7	25	30	5.87	19.29	0.070	25.31	4.30	5.16

Note 1:Nominal Current . Is the current taking 5 sec. to discharge from  $U_R$  to  $1/2U_R$ .

Note 2:Maximum Peak Current . Is the current taking 1 sec. to discharge from  $U_R$  to  $1/2U_R$

Body color : Black

### Outline and Dimensions

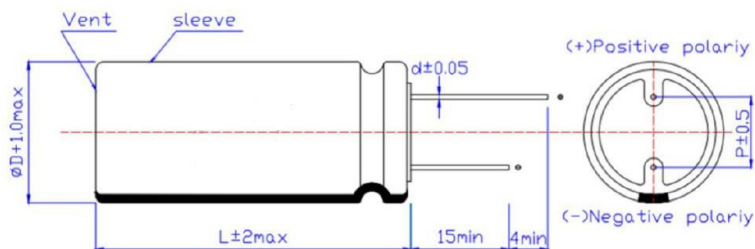

The actual size and tolerance shall be subject to the parameter table.

**Dimensions**

Part No.	D (mm)	L (mm)	P (mm)	d (mm)
IXSCAL2V7504MH	6.3±1.0	12.5±1.5	2.5±0.5	0.5±0.05
IXSCAL2V7105MH	8.0±1.0	13.0±1.5	3.5±0.5	0.6±0.05
IXSCAL2V7205MH	8.0±1.0	16.0±1.5	3.5±0.5	0.6±0.05
IXSCAL2V7205MH-1	8.0±1.0	20.0±1.5	3.5±0.5	0.6±0.05
IXSCAL2V7305MH	8.0±1.0	20.0±1.5	3.5±0.5	0.6±0.05
IXSCAL2V7335MH	8.0±1.0	20.0±1.5	3.5±0.5	0.6±0.05
IXSCAL2V7505MH	8.0±1.0	24.0±1.5	3.5±0.5	0.6±0.05
IXSCAL2V7605MH	10.0±1.0	20.0±1.5	5.0±0.5	0.6±0.05
IXSCAL2V7705MH	10.0±1.0	20.0±1.5	5.0±0.5	0.6±0.05
IXSCAL2V7106MH	10.0±1.0	25.0±2.0	5.0±0.5	0.6±0.05
IXSCAL2V7256MH	16.0±1.0	25.0±2.0	7.5±0.5	0.8±0.05

**Packaging Quantity**

Part No.	Quantity (EA)
	Plastic Bag
IXSCAL2V7504MH	2000
IXSCAL2V7105MH	1500
IXSCAL2V7205MH	1000
IXSCAL2V7205MH-1	1000
IXSCAL2V7305MH	1000
IXSCAL2V7335MH	1000
IXSCAL2V7505MH	1000
IXSCAL2V7605MH	800
IXSCAL2V7705MH	800
IXSCAL2V7106MH	600
IXSCAL2V7256MH	250

## ❖ Environmental Characteristics

Item	Requirement		Test Condition	
Characteristics in different temperature	Step 2	△C	Less than or equal to 30% of the initial value	Step 1: +25°C±2°C Step 2: -25°C±2°C Step 3: +85°C±2°C Step 4: +25°C±2°C
		ESR	Less than or equal to 400% of the initial value	
	Step 3	△C	Less than or equal to 30% of the initial value	
		ESR	Less than or equal to the initial value	
	Step 4	△C	Satisfies the range of 20% of the initial rating	
		ESR	Satisfies the initial value	
Endurance	△C	Less than or equal to 30% of the initial value	Applied voltage : Rated voltage Temperature : Upper limit temperature Time : 1000h	
	ESR	Less than or equal to 4 times the initial value		
	Appearance	No leakage or mechanical damage		
Cycle life	△C	Less than or equal to 30% of the initial value	At 25°C, charge to the rated voltage with constant current, stand for 5s, discharge to 50% voltage with constant current, stand for 5s, cycle 100000	
	ESR	Less than or equal to 3 times the initial value		
Humidity Characteristics	△C	Less than or equal to 30% of the initial value	Temperature: +40°C±2°C Relative humidity: 90~95%RH Test time: 240h	
	ESR	Less than or equal to 4 times the initial value		
	Appearance	No leakage or mechanical damage		
Temperature cycle	△C	Less than or equal to 10% of the initial value	Temperature cycle : Lower limit temperature →normal temperature →Upper limit temperature →normal temperature Cycles : 5	
	Appearance	No leakage or mechanical damage		
Low temperature storage characteristics	△C	Satisfies the range of 10% of the initial rating	Applied voltage : 0V Temperature : Lower limit temperature Time : 96h	
	ESR	Less than or equal to 2 times the initial value		
	Appearance	No leakage or mechanical damage		
High temperature storage characteristics	△C	Satisfies the range of 10% of the initial rating	Applied voltage : 0V Temperature : Upper limit temperature Time : 96h	
	ESR	Less than or equal to 2 times the initial value		
	Appearance	No leakage or mechanical damage		
Self discharge characteristics (voltage holding characteristics)	Voltage between positive and negative poles≥80%U <sub>R</sub>		Charging process: normal temperature, no load, rated voltage charge24h Placement process: temperature less than or equal to 25 °C, relative humidity less than 60% RH, open 24 h	
Lead strength	No damage to the outlet			
Solder ability	More than 3/4 of the terminal surface is covered by a tin layer			

**Storage Temperature: -30~50°C;Relative Humidity:<60%RH, Max. Humidity<85%RH**

**Citation standards:IEC62391-1 &DL T 1652-2016**

## ❖ Standard Combined Type Supercapacitor

### Specifications

Performance	Performance Characteristics	Notes
Capacitance Range	0.22~25F	$I=8*CU_R(\text{mA})$
Capacitance Tolerance	$\pm 20\%$ , +80/-20%, +30/-10%	@25°C
Rated Voltage	5.5V	DC
Operating Temperature Range	-40°C~+70°C	

### Specifications Value of Standard Product

Part No.	Rated Voltage (V)	Capacitance (F)	Max. ESR DC 25°C (mΩ)	Nominal Current (25°C, A)	Maximum Peak Current (25°C<1s, A)	Leakage Current (25°C72h, mA)	Store energy (mWh)	Energy density (Wh/kg)	Power density (kW/kg)
IXSCAZ5V5224Z	5.5	0.22	1200	0.11	0.48	0.006	0.92	1.02	3.46
IXSCAZ5V5474M	5.5	0.47	500	0.25	1.05	0.010	1.97	2.10	8.05
IXSCAZ5V54749	5.5	0.47	500	0.25	1.05	0.010	1.97	2.10	8.05
IXSCAZ5V5105Z	5.5	1	400	0.51	1.96	0.013	4.20	2.33	5.25
IXSCAZ5V5155M	5.5	1.5	220	0.77	3.10	0.015	6.30	2.85	5.70
IXSCAZ5V5255M	5.5	2.5	160	1.27	4.91	0.016	10.50	3.22	7.25
IXSCAZ5V5355M	5.5	3.5	150	1.74	6.31	0.028	14.70	3.08	5.27
IXSCAZ5V5505M	5.5	5	120	2.46	8.59	0.030	21.01	3.83	5.75
IXSCAZ5V5505M-1	5.5	5	120	2.46	8.59	0.030	21.01	3.83	5.75
IXSCAZ5V5156M	5.5	15	100	6.35	16.50	0.078	63.02	4.12	2.47
IXSCAZ5V5256M	5.5	25	40	11.46	34.38	0.096	105.03	5.76	5.18

**Nominal Current** . Is the current taking 5 sec. to discharge from  $U_R$  to  $1/2U_R$ .

**Maximum Peak Current** . Is the current taking 1 sec. to discharge from  $U_R$  to  $1/2U_R$

Body color : Blue

### Outline and Dimensions

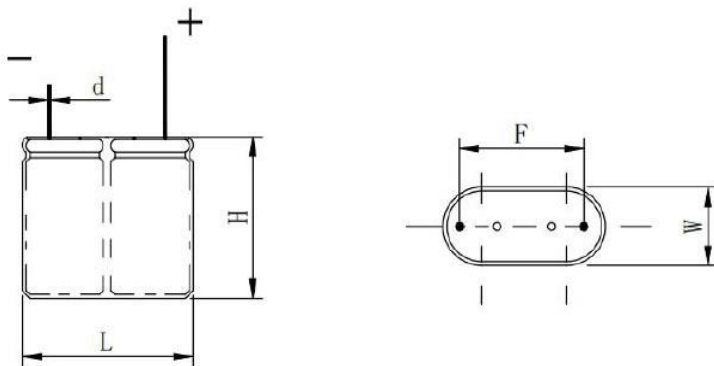

The actual size and tolerance shall be subject to the parameter table.



### Dimensions

Part No.	L (mm)	W (mm)	H (mm)	F (mm)	d (mm)
IXSCAZ5V5224Z	13.5±1.0	6.5±1.0	13.8±2.0	9.0±0.5	0.5±0.05
IXSCAZ5V5474M	13.5±1.0	6.5±1.0	13.8±2.0	9.0±0.5	0.5±0.05
IXSCAZ5V54749	17.0±1.0	8.5±1.0	14.0±2.0	12.0±0.5	0.6±0.05
IXSCAZ5V5105Z	17.0±1.0	8.5±1.0	21.0±2.0	12.0±0.5	0.6±0.05
IXSCAZ5V5155M	17.0±1.0	8.5±1.0	21.0±2.0	12.0±0.5	0.6±0.05
IXSCAZ5V5255M	17.0±1.0	8.5±1.0	25.0±2.0	12.0±0.5	0.6±0.05
IXSCAZ5V5355M	21.0±1.0	10.0±1.0	21.0±2.0	15.5±0.5	0.6±0.05
IXSCAZ5V5505M	21.0±1.0	10.0±1.0	26.0±2.0	15.5±0.5	0.6±0.05
IXSCAZ5V5505M-1	26.0±1.0	13.0±1.0	27.0±2.0	18.0±0.5	0.6±0.05
IXSCAZ5V5156M	32.0±1.0	16.0±1.0	32.0±2.0	24.0±0.5	0.8±0.05
IXSCAZ5V5256M	36.0±1.0	18.0±1.0	43.0±2.0	26.0±0.5	0.8±0.05

### Packaging Quantity

Part No.	Quantity (EA)
	Plastic Bag
IXSCAZ5V5224Z	1000
IXSCAZ5V5474M	1000
IXSCAZ5V54749	600
IXSCAZ5V5105Z	500
IXSCAZ5V5155M	500
IXSCAZ5V5255M	400
IXSCAZ5V5355M	350
IXSCAZ5V5505M	300
IXSCAZ5V5505M-1	200
IXSCAZ5V5156M	100
IXSCAZ5V5256M	40

## ❖ Environmental Characteristics

Item	Requirement		Test Condition
Characteristics in different temperature	Step 2	ΔC	Less than or equal to 30% of the initial value
		ESR	Less than or equal to 400% of the initial value
	Step 3	ΔC	Less than or equal to 30% of the initial value
		ESR	Less than or equal to the initial value
	Step 4	ΔC	Satisfies the range of 20% of the initial rating
		ESR	Satisfies the initial value
Endurance	ΔC	Less than or equal to 30% of the initial value	Applied voltage : Rated voltage Temperature : Upper limit temperature Time : 1000h
	ESR	Less than or equal to 4 times the initial value	
	Appearance	No leakage or mechanical damage	
Cycle life	ΔC	Less than or equal to 30% of the initial value	At 25°C, charge to the rated voltage with constant current, stand for 5s, discharge to 50% voltage with constant current, stand for 5s, cycle 100000
	ESR	Less than or equal to 3 times the initial value	
Humidity Characteristics	ΔC	Less than or equal to 30% of the initial value	Temperature: +40°C±2°C Relative humidity: 90~95%RH Test time: 240h
	ESR	Less than or equal to 4 times the initial value	
	Appearance	No leakage or mechanical damage	
Temperature cycle	ΔC	Less than or equal to 10% of the initial value	Temperature cycle : Lower limit temperature →normal temperature →Upper limit temperature →normal temperature Cycles : 5
	Appearance	No leakage or mechanical damage	
Low temperature storage characteristics	ΔC	Satisfies the range of 10% of the initial rating	Applied voltage : 0V Temperature : Lower limit temperature Time : 96h
	ESR	Less than or equal to 2 times the initial value	
	Appearance	No leakage or mechanical damage	
High temperature storage characteristics	ΔC	Satisfies the range of 10% of the initial rating	Applied voltage : 0V Temperature : Upper limit temperature Time : 96h
	ESR	Less than or equal to 2 times the initial value	
	Appearance	No leakage or mechanical damage	
Self discharge characteristics (voltage holding characteristics)	Voltage between positive and negative poles ≥ 80%U <sub>R</sub>		Charging process: normal temperature, no load, rated voltage charge 24h Placement process: temperature less than or equal to 25 °C, relative humidity less than 60% RH, open 24 h
Lead strength	No damage to the outlet		
Solder ability	More than 3/4 of the terminal surface is covered by a tin layer		

**Storage Temperature: -30~50°C; Relative Humidity: <60%RH, Max. Humidity <85%RH**

**Citation standards: IEC62391-1 & DL T 1652-2016**

## ❖ High Voltage Combined Type Supercapacitor

### Specifications

Performance	Performance Characteristics	Notes
Capacitance Range	0.5~5F	$I=8*CU_R(\text{mA})$
Capacitance Tolerance	±20%	@25°C
Rated Voltage	6.0V	DC
Operating Temperature Range	-40°C~+70°C	

### Specifications Value of Product

Part No.	Rated Voltage (V)	Capacitance (F)	Max. ESR DC 25°C (mΩ)	Nominal Current (25°C, A)	Maximum Peak Current (25°C<1s, A)	Leakage Current (25°C72h, mA)	Store energy (mWh)	Energy density (Wh/kg)	Power density (kW/kg)
IXSCAZ6V0504MV	6.0	0.5	800	0.28	1.15	0.010	2.03	1.81	3.13
IXSCAZ6V0105MV	6.0	1	500	0.55	2.00	0.013	3.34	1.45	3.29
IXSCAZ6V0505MV	6.0	5	150	2.61	8.57	0.032	2.50	1.07	2.41

**Nominal Current** . Is the current taking 5 sec. to discharge from  $U_R$  to  $1/2U_R$ .

**Maximum Peak Current** . Is the current taking 1 sec. to discharge from  $U_R$  to  $1/2U_R$

**Body color** : Blue

### Outline and Dimensions

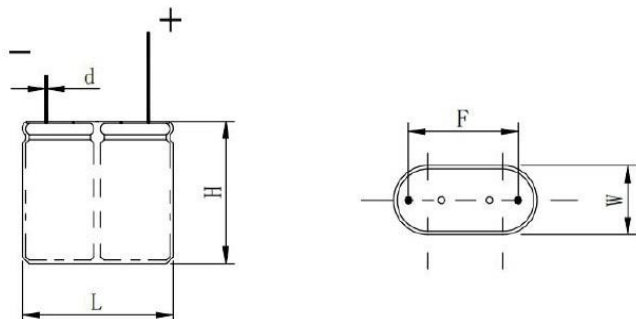

The actual size and tolerance shall be subject to the parameter table

### Dimensions

Part No.	L (mm)	W (mm)	H (mm)	F (mm)	d (mm)
IXSCAZ6V0504MV	13.5±1.0	6.5±0.5	13.8±1.0	9.0±0.5	0.5±0.05
IXSCAZ6V0105MV	17.0±1.0	8.5±0.5	21.0±1.0	12.0±0.5	0.6±0.05
IXSCAZ6V0505MV	21.0±1.0	10.0±1.0	26.0±1.5	15.5±0.5	0.6±0.05

### Packaging Quantity

Part No.	Quantity(EA)
	Plastic Bag
IXSCAZ6V0504MV	1000
IXSCAZ6V0105MV	500
IXSCAZ6V0505MV	300

## ❖ Environmental Characteristics

Item	Requirement		Test Condition	
Characteristics in different temperature	Step 2	△C	Less than or equal to 30% of the initial value	Step 1 : +25°C±2°C Step 2 : -25°C±2°C Step 3 : +70°C±2°C Step 4 : +25°C±2°C
		ESR	Less than or equal to 400% of the initial value	
	Step 3	△C	Less than or equal to 30% of the initial value	
		ESR	Less than or equal to the initial value	
	Step 4	△C	Satisfies the range of 20% of the initial rating	
		ESR	Satisfies the initial value	
Endurance	△C	Less than or equal to 30% of the initial value	Applied voltage : Rated voltage Temperature : Upper limit temperature Time : 1000h	
	ESR	Less than or equal to 4 times the initial value		
	Appearance	No leakage or mechanical damage		
Cycle life	△C	Less than or equal to 30% of the initial value	At 25°C, charge to the rated voltage with constant current, stand for 5s, discharge to 50% voltage with constant current, stand for 5s, cycle 100000	
	ESR	Less than or equal to 3 times the initial value		
Humidity Characteristics	△C	Less than or equal to 30% of the initial value	Temperature: +40°C±2°C Relative humidity: 90~95%RH Test time: 240h	
	ESR	Less than or equal to 4 times the initial value		
	Appearance	No leakage or mechanical damage		
Temperature cycle	△C	Less than or equal to 10% of the initial value	Temperature cycle : Lower limit temperature →normal temperature →Upper limit temperature →normal temperature Cycles : 5	
	Appearance	No leakage or mechanical damage		
Low temperature storage characteristics	△C	Satisfies the range of 10% of the initial rating	Applied voltage : 0V Temperature : Lower limit temperature Time : 96h	
	ESR	Less than or equal to 2 times the initial value		
	Appearance	No leakage or mechanical damage		
High temperature storage characteristics	△C	Satisfies the range of 10% of the initial rating	Applied voltage : 0V Temperature : Upper limit temperature Time : 96h	
	ESR	Less than or equal to 2 times the initial value		
	Appearance	No leakage or mechanical damage		
Self discharge characteristics (voltage holding characteristics)	Voltage between positive and negative poles $\geq 80\%U_R$		Charging process: normal temperature, no load, rated voltage charge 24h Placement process: temperature less than or equal to 25 °C, relative humidity less than 60% RH, open 24 h	
Lead strength	No damage to the outlet			
Solder ability	More than 3/4 of the terminal surface is covered by a tin layer			

**Storage Temperature: -30~50°C; Relative Humidity:<60%RH, Max. Humidity<85%RH**

**Citation standards: IEC62391-1 &D T 1652-2016**

## ❖ High Temperature Combined Type Supercapacitor

### Specifications

Performance	Performance Characteristics	Notes
Capacitance Range	0.47~25F	$I=8*CU_R(\text{mA})$
Capacitance Tolerance	±20%	@25°C
Rated Voltage	5.5V	DC
Operating Temperature Range	-40°C~+85°C	

### Specifications Value of Product

Part No.	Rated Voltage (V)	Capacitance (F)	Max. ESR DC 25°C (mΩ)	Nominal Current (25°C, A)	Maximum Peak Current (25°C<1s, A)	Leakage Current (25°C 72h, mA)	Store energy (mWh)	Energy density (Wh/kg)	Power density (kW/kg)
IXSCAZ5V5474MH	5.5	0.47	600	0.24	1.01	0.010	2.03	1.08	3.46
IXSCAZ5V5155MH	5.5	1.5	220	0.77	3.10	0.015	3.03	2.42	6.61
IXSCAZ5V5155MH-1	5.5	1.5	240	0.77	3.03	0.015	4.03	2.38	5.95
IXSCAZ5V5205MH	5.5	2	200	1.02	3.93	0.016	5.03	3.15	7.08
IXSCAZ5V5255MH	5.5	2.5	180	1.26	4.74	0.018	6.03	3.62	7.24
IXSCAZ5V5355MH	5.5	3.5	150	1.74	6.31	0.028	7.03	3.77	6.46
IXSCAZ5V5405MH	5.5	4	140	1.98	7.05	0.032	8.03	4.10	6.59
IXSCAZ5V5505MH	5.5	5	140	2.41	8.09	0.036	9.06	4.86	6.25
IXSCAZ5V5106MH	5.5	10	100	4.58	13.75	0.064	8.96	4.69	4.22
IXSCAZ5V5256MH	5.5	25	70	10.19	25.00	0.120	11.03	7.40	3.80

Nominal Current : Is the current taking 5 sec. to discharge from  $U_R$  to  $1/2U_R$ .

Maximum Peak Current . Is the current taking 1 sec. to discharge from  $U_R$  to  $1/2U_R$

Body color : Black

### Outline and Dimensions

Fig1

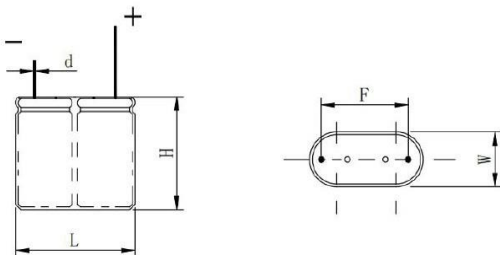
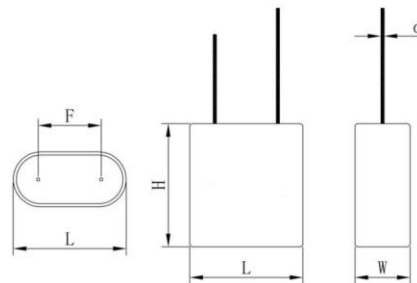

Fig2



The actual size and tolerance shall be subject to the parameter table

### Dimensions

Part No.	Figure	L (mm)	W (mm)	H (mm)	F (mm)	d (mm)
IXSCAZ5V5474MH	1	13.5±1.0	6.5±1.0	13.8±2.0	9.0±0.5	0.5±0.05
IXSCAZ5V5155MH	2	17.0±1.0	8.5±1.0	21.0±2.0	12.0±0.5	0.6±0.05
IXSCAZ5V5155MH-1	2	18.6±1.0	10.5±1.0	23.5±1.0	12.0±0.5	0.6±0.20
IXSCAZ5V5205MH	1	17.0±1.0	8.5±1.0	25.0±2.0	12.0±0.5	0.6±0.05
IXSCAZ5V5255MH	1	17.0±1.0	8.5±1.0	25.0±2.0	12.0±0.5	0.6±0.05
IXSCAZ5V5355MH	1	21.0±1.0	10.0±1.0	21.0±2.0	15.5±0.5	0.6±0.05
IXSCAZ5V5405MH	1	21.0±1.0	10.0±1.0	26.0±1.5	15.5±0.5	0.6±0.05
IXSCAZ5V5505MH	1	25.0±1.0	12.5±1.0	21.0±2.0	18.0±0.5	0.6±0.05
IXSCAZ5V5106MH	1	32.0±1.0	16.0±1.0	27.0±2.0	24.0±0.5	0.8±0.05
IXSCAZ5V5256MH	1	36.0±1.0	18.0±1.0	43.0±2.0	28.0±0.5	0.8±0.05

**Packaging Quantity**

Part No.	Quantity (EA)
	Plastic Bag
IXSCAZ5V5474MH	1000
IXSCAZ5V5155MH	500
IXSCAZ5V5155MH-1	400
IXSCAZ5V5205MH	400
IXSCAZ5V5255MH	400
IXSCAZ5V5355MH	350
IXSCAZ5V5405MH	300
IXSCAZ5V5505MH	250
IXSCAZ5V5106MH	125
IXSCAZ5V5256MH	40

## ❖ Environmental Characteristics

Item	Requirement		Test Condition	
Characteristics in different temperature	Step 2	ΔC	Less than or equal to 30% of the initial value	Step 1 : +25°C±2°C Step 2 : -25°C±2°C Step 3 : +85°C±2°C Step 4 : +25°C±2°C
		ESR	Less than or equal to 400% of the initial value	
	Step 3	ΔC	Less than or equal to 30% of the initial value	
		ESR	Less than or equal to the initial value	
	Step 4	ΔC	Satisfies the range of 20% of the initial rating	
		ESR	Satisfies the initial value	
Endurance	ΔC	Less than or equal to 30% of the initial value	Applied voltage : Rated voltage Temperature : Upper limit temperature Time : 1000h	
	ESR	Less than or equal to 4 times the initial value		
	Appearance	No leakage or mechanical damage		
Cycle life	ΔC	Less than or equal to 30% of the initial value	At 25°C, charge to the rated voltage with constant current, stand for 5s, discharge to 50% voltage with constant current, stand for 5s, cycle 100000	
	ESR	Less than or equal to 3 times the initial value		
Humidity Characteristics	ΔC	Less than or equal to 30% of the initial value	Temperature: +40°C±2°C Relative humidity: 90~95%RH Test time: 240h	
	ESR	Less than or equal to 4 times the initial value		
	Appearance	No leakage or mechanical damage		
Temperature cycle	ΔC	Less than or equal to 10% of the initial value	Temperature cycle : Lower limit temperature →normal temperature →Upper limit temperature →normal temperature Cycles : 5	
	Appearance	No leakage or mechanical damage		
Low temperature storage characteristics	ΔC	Satisfies the range of 10% of the initial rating	Applied voltage : 0V Temperature : Lower limit temperature Time : 96h	
	ESR	Less than or equal to 2 times the initial value		
	Appearance	No leakage or mechanical damage		
High temperature storage characteristics	ΔC	Satisfies the range of 10% of the initial rating	Applied voltage : 0V Temperature : Upper limit temperature Time : 96h	
	ESR	Less than or equal to 2 times the initial value		
	Appearance	No leakage or mechanical damage		
Self discharge characteristics (voltage holding characteristics)	Voltage between positive and negative poles≥80%U <sub>R</sub>		Charging process: normal temperature, no load, rated voltage charge24h Placement process: temperature less than or equal to 25 °C, relative humidity less than 60% RH, open 24 h	
Lead strength	No damage to the outlet			
Solder ability	More than 3/4 of the terminal surface is covered by a tin layer			

**Storage Temperature: -30~50°C; Relative Humidity:<60%RH, Max. Humidity<85%RH**

**Citation standards: IEC62391-1 &DL T 1652-2016**

## ❖ Measuring Method

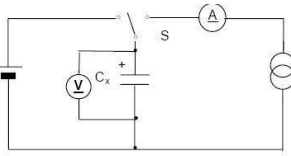
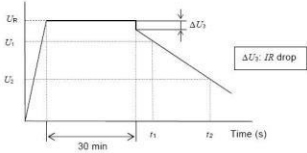
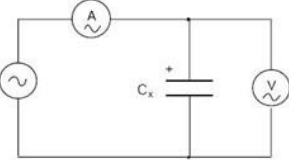
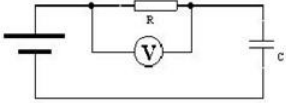
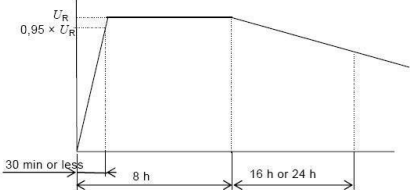
<p>Capacitance</p>	<p>Measurement by Permanent electrotransport :</p> <ol style="list-style-type: none"> <li>1.DC voltage of constant current/constant voltage source is set as rated voltage (UR). 2.Set the constant current value of the constant current discharge device.</li> <li>3. Switch the switch S to dc power supply, and charge at constant voltage for 30min after the constant current/constant voltage source reaches the rated voltage.</li> <li>4. After charging for 30min, switch S is changed to the constant exile device to discharge with constant current.</li> <li>5. Measure the time t1 and t2 of the voltage from U1 to U2 at both ends of the capacitor, as shown in the figure, and calculate the capacitance value according to the following equation</li> </ol>   $C = \frac{I \times (t_2 - t_1)}{U_1 - U_2}$
<p>Resistance</p>	<p>AC impedance measurement The circuit as shown in the figure below is used for measurement</p>  <p>Capacitor resistance Ra shall be computed by the type:</p> $R_a = \frac{U}{I}$ <p>Ra ac impedance (Ω); Effective value of U ac voltage (V R.M.S); Effective value of I ac current (V R.M.S).</p>
<p>Leakage Current</p>	<p>DC leakage current measurement principle is as follows</p>  <ol style="list-style-type: none"> <li>1. Discharge: before the measurement begins, the capacitor should be fully discharged. The discharge process lasts from 1h to 24h.</li> <li>2. Leakage current shall be measured at rated temperature and rated voltage (UR). The charging voltage reached 95% after the maximum 30min charging time. The charging time was selected from 30min ,1h , 2h , 4h , 8h , 12h , 24h , 48h , 72h and shall be specified in the detail specification 3. Stable power supply, such as dc stabilized power supply, should be used.</li> <li>4. through the protection under 1000 Ω resistance to capacitor voltage</li> </ol>
<p>Self discharge</p>	<p>Before the measurement begins, the capacitor should be fully discharged. The discharge process lasts from 1h to 24h. The rated voltage U should be directly applied at both ends of the capacitor, without protection resistance. Capacitors should be placed at standard ambient temperature and pressure for 24 hours. DC voltmeter internal resistance should be greater than 1 MΩ.</p> 



## ❖ Soldering Condition

The welding condition of the proposed product is flow welding, as shown below:

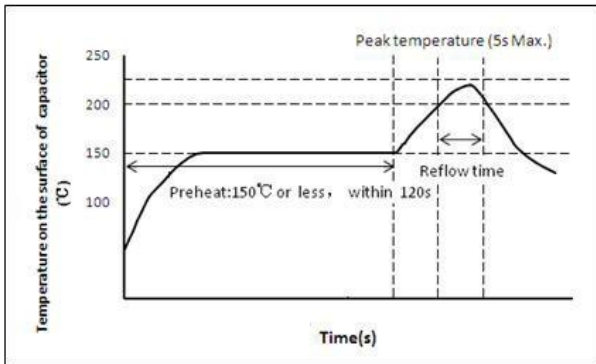

Care should be taken when welding:

1. Carry out low-temperature welding in accordance with the above welding conditions within a short time.
2. When the voltage is above 0.3V, do not backflow welding
3. Please consult us for more conditions of reflow soldering.
4. For the welding of lithium-ion capacitors, it is recommended to consult the manufacturer whether it can be soldered

## ❖ Cautions For Use

### 1. Polarity problem of supercapacitor

Unlike ordinary electrolytic capacitors or batteries, the anode and cathode of supercapacitors are made of the same material, so there is no polarity in theory. However, the polarity indicated by super capacitors is formulated by the manufacturer in the production process. When the capacitor is used carelessly in the short-term reverse operation, it will not cause substantial damage to the capacitor. If adjusted to a positive direction, it can be guaranteed to be used, but it cannot be used in the long-term reverse operation, which will result in the rapid attenuation of capacitor life characteristics.

### 2. On the issue of supercapacitor charging

Charging of supercapacitors requires dc voltage which does not exceed rated voltage, and various charging methods such as current limit, constant current, constant power and constant voltage can be adopted. Supercapacitors can be charged by lowering the voltage of the charging power supply until the capacitors are full enough to maintain voltage balance.

### 3. The problem of internal resistance and capacity of supercapacitors

In the process of charging and discharging, super capacitor resistance caused by the IR drop, lose efficiency of capacitor charging and discharging, so the size of capacitor resistance to a certain extent, determines the actor bad of character of capacitor, due to the internal resistance of the super capacitor than normal capacitors, in the process of communication charge and discharge circuit or high frequency, capacitor will fever, cause life decay quickly, which is the cause of the super capacitor only commonly used in dc.

Compared with ordinary capacitors, supercapacitors have a larger time constant, so the charge-discharge time is relatively long, and because of this, it is not suitable for continuous large current to work frequently, which will cause rapid attenuation of the heating performance. The frequency characteristic of supercapacitors is that the response time of positive and negative ions in the micro pores of carbon electrode is long at high frequency. Instead of measuring capacitors' ac capacity, the mAh method based on battery measurement is used.

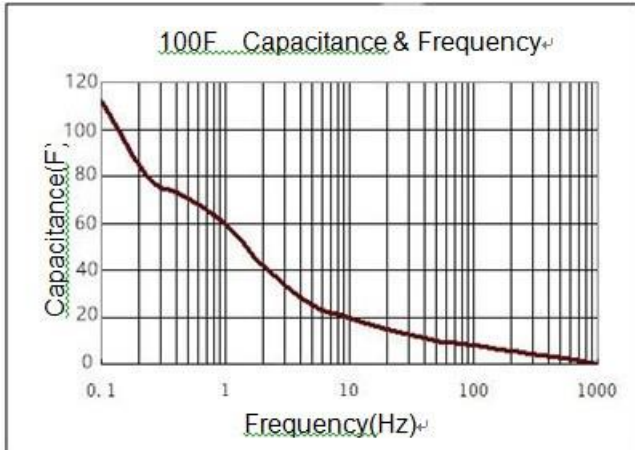

**Except Lithium Ion**

**4. Transport and storage**

Should prevent products be affected with damp be affected with damp in product transportation, storage temperature should be -30 °C to 50 °C, relative humidity less than 60%, the maximum humidity no more than 85%, otherwise it will cause capacitance performance degradation of be affected with damp be affected with damp or rust.

Lithium ion :The Super Capacitor should be stored at room temperature, charged to about 50% ~ 80% of capacity; We recommend that Asymmetry Super Capacitor be charged about once per half a year to prevent over discharge.

Should prevent products be affected with damp be affected with damp in product transportation, storage temperature should be -20 °C to 50 °C, relative humidity less than 65%, the maximum humidity no more than 65%, otherwise it will cause capacitance performance degradation of be affected with damp be affected with damp or rust.

**5. Installation and welding**

When the supercapacitor is used on the double-sided circuit board, it should be noted that the connection cannot pass through the reach of the capacitor, otherwise the product will be short circuit overvoltage and the capacitor will be damaged. During installation and after installation, do not twist or tilt the capacitor by force. Do not pull the lead by force.

Break the needle and weld after bending. In the welding process to avoid overheating of the capacitor (1.6 mm of printed circuit board, the welding should be 260 °C, when time is not more than 5 s), after welding, circuit board and the capacitor to clean in the net.

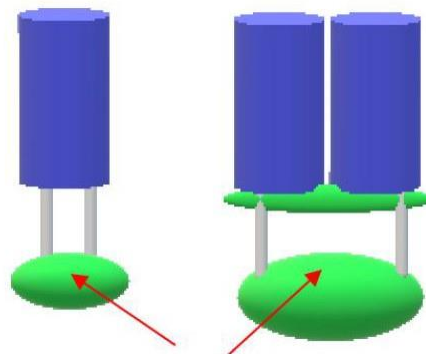

try not to wire here

#### **6.Short circuit judgment of supercapacitor**

The short circuit capacitance shall not be charged or discharged. The dc voltage shall be applied between the positive and negative terminals of the capacitance. The capacitance voltage shall not be increased When charging, it is normal to use ohm gauge (short circuit block) indicator as short circuit state. Capacitance is short circuit and it cannot be determined. It should be observed whether the resistance value increases or not.

#### **7.Series and parallel operation problem**

When the same super capacitor is used in series, the total voltage = series number \* monomer withstand voltage;  
Total capacity = unit capacity Total energy = series number x monomer capacity, total internal resistance = series number x monomer resistance.

There is a problem of voltage balancing between three or more monomers in series, so it is necessary to consider adopting equalizing circuit to ensure that the capacitance cannot be used over voltage during long-term use, thus causing capacitor life attenuation and damage.

Supercapacitors of different specifications cannot be used in series.

When the super capacitors are used in parallel, they can be connected in parallel with different capacitance values and charged by the same voltage. However, it is necessary to pay attention to the current balance between the capacitors and to isolate each other, so as to avoid reverse charging due to the potential difference after discharge.

**8.For other problems in use, please consult the manufacturer or refer to the relevant technical data of the instructions for the use of supercapacitors.**

#### **9.Handling of leakage situation**

Skin contact: rinse skin thoroughly with soap and water;

Eye contact: flush with flowing water or normal saline and seek medical advice; Absorb: immediately rinse with water and seek medical advice; If the supercapacitor is found to be overheating or smelling, the power supply and load connected to the supercapacitor should be disconnected immediately to cool it, and the supercapacitor should be treated properly so that no face or hand contact with the supercapacitor is allowed.

# Sales and Support

Infinex Headquarters  
12455-G Research Blvd.  
Austin, TX USA 78759

[sales@infinex.com](mailto:sales@infinex.com)  
[engineering@infinex.com](mailto:engineering@infinex.com)

Infinex, a Flex company (including its affiliates, employees, agents and other persons acting on Infinex's behalf), reserve the right to make modifications, improvements, corrections or other changes without further notice to any product herein. The product information is provided only for reference purposes and Infinex does not assume any liability arising out of an application or use of any product described herein and disclaims any warranties expressed or implied; neither does it convey any license under its patent rights, nor the right of others. The user of products in such applications shall assume all risks of such use and will agree to hold Infinex, and all the companies whose products are represented on our website, harmless against all damages.

© 2023 Flex Ltd. and its affiliates. All rights reserved. Infinex and the Infinex logo are trademarks of Flex Ltd. No part of this document can be reproduced in any form without the written permission of Infinex.

Document Revision Number: 2.0, 03/28/2023

Infinex, a Flex company, is a global components manufacturer that provides cost-effective, sustainable supply chain solutions. Specializing in high-quality passive and frequency management components, antennas, semiconductors, mechanicals, interconnect cables and connectors, Infinex core technologies enable design innovation in a broad range of end-use applications in every industry. By combining a differentiated, highly responsive supply chain with a global footprint, Infinex serves its customers everywhere they require. Recognized for global operational excellence and trusted strategic partnerships, Infinex empowers customers to improve efficiencies, speed time to market and build a significant competitive advantage that lasts. Learn more at [infinex.com](https://infinex.com).

For more information, visit  
[infinex.com](https://infinex.com)