

INFINETMX

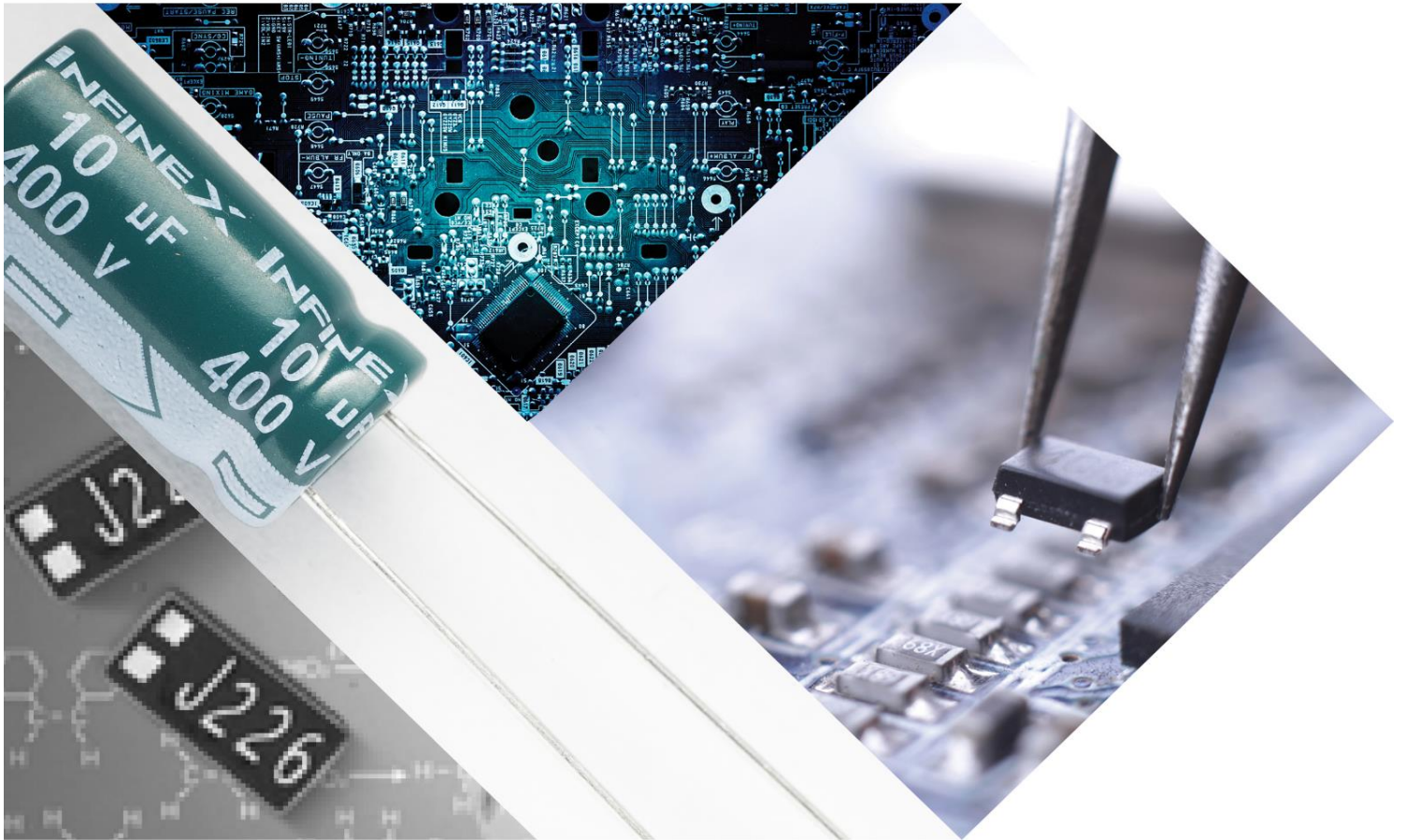

Multi Layer Ceramic Capacitor Catalogue

Table of Contents

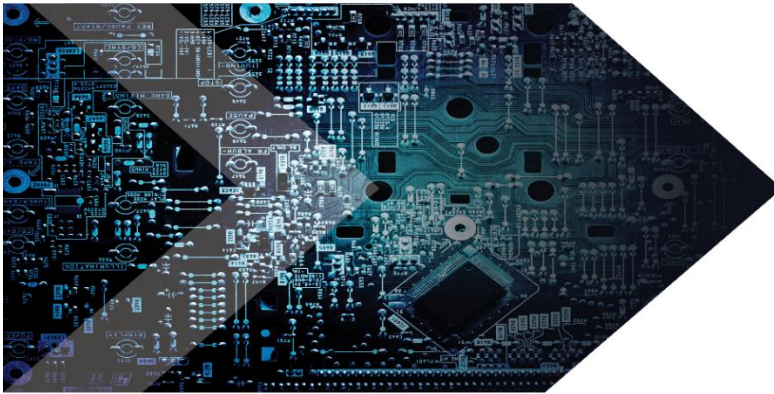

➤ MLCC Series Index	3
➤ Part Numbering System	4
➤ Standard & High capacitors	7
➤ Super Small Size Capacitors	29
➤ High-Q Capacitors	33
➤ Medium High Voltage Capacitors	35
➤ Array Type Capacitors	44
➤ Low ESL Type Capacitors	47
➤ Reliability Test Condition	50
➤ Automotive Type Capacitors	55
➤ Packaging Specification	67
➤ Application Manual for Surface Mounting	73
➤ Disclaimer	78

Multi Layer Ceramic Capacitor – Series Index

Series Type		Type
Multi Layer Ceramic Capacitors	XC	Standard & High Capacitors
		Super Small Size Capacitors
		High-Q Capacitors
		Medium-High Voltage Capacitors
		Array Type Capacitors
		Low ESL Type Capacitors
		Automotive Type capacitors

Part Numbering System:

XC	0201	A	106	M	P	8	C	N	N	-	S
1) Series Code	2) Case Size Code	3) Dielectric Code	4) Capacitance Code	5) Tolerance Code	6) Voltage Code	7) Thickness Code	8) Packaging Code	9) Product Code	10) Design Code		11) Control Code

➤ **Explanation of Part Numbers**

1) Series Code

XC – InfineX Chip Capacitors

2) Case Size Code: Inch (mm)

Size code Inch (mm)	01005 (0402)	0201 (0603)	0402 (1005)	0603 (1608)	0805 (2012)	1206 (3216)	1210 (3225)	1808 (4520)	1812 (4532)	2220 (5750)
---------------------	--------------	-------------	-------------	-------------	-------------	-------------	-------------	-------------	-------------	-------------

3) Dielectric Code:

Class I	Class II	
C=C0G	A=X5R	F=Y5V
	B=X7R	X=X6S
	Y=X7S	Z=X7T

Class I (Temperature Compensation)

Symbol	EIA Code	Operation Temperature Range(°C)	Temperature Coefficient Range(ppm/ °C)
C	C0G	-55 ~ +125	0+30

Class II (High Dielectric Constant)

Symbol	EIA Code	Operation Temperature Range(°C)	Capacitance Change (ΔC%)
A	X5R	-55 ~ + 85	±15
B	X7R	-55 ~ +125	±15
X	X6S	-55 ~ +105	±22
F	Y5V	-30 ~ + 85	-82 ~ +22
Y	X7S	-55 ~ +125	±22
Z	X7T	-55 ~ +125	-33 ~ +22

4) Capacitance Code:

Capacitance expressed in pF.
 2 significant digits plus number of zeros.
 Example) 10⁶=10x10⁶=1000000pF
 For Values < 10pF, Letter R denotes decimal point
 Example) 1R5=1.5pF

Series	TC	Capacitance Step																	
E 3	Y5V	1.0				2.2				4.7									
E 6	X5R	1.0	1.5	2.2	3.3	4.7	6.8												
	X7R																		
	X6S																		
	X7S																		
	X7T																		
E 12	COG	1.0	1.2	1.5	1.8	2.2	2.7	3.3	3.9	4.7	5.6	6.8	8.2						

5) Tolerance Code:

Code	B	C	D	F	G	J	K	M	Z
Tolerance (%)	±0.1pF	±0.25pF	±0.5pF	±1pF, ±1%*	±2%	±5%	±10%	±20%	+80/-20%

*For Values ≤ 10pF, F=±1pF & Values > 10pF, F=±1%

6) Rated Voltage Code:

Code	R	Q	P	O	A	L	B	C	D	E	F	G	H	I	J	K
Voltage (V)	4	6.3	10	16	25	35	50	100	200	250	350	500	630	1000	2000	3000

7) Thickness Code:

Code	2	3	5	8	9	A	C	D	E	F	H	I
(mm)	0.20	0.30	0.50	0.80	0.90	0.65	0.85	1.00	1.10	1.25	1.60	2.00
Code	J	L	M	P	Q	S	U	V	Y			
(mm)	2.50	3.20	1.15	1.15	1.25	1.35	1.80	2.50	1.25			

Size Inch (mm)	Code	Thickness(mm)	Spec(mm)	Size Inch (mm)	Code	Thickness(mm)	Spec(mm)
01005(0402)	2	0.20	±0.02	1210(3225)	C	0.85	±0.10*
0201(0603)	3	0.30	±0.03		9	0.90	±0.10*
0402(1005)	3	0.30	±0.03*		F	1.25	±0.20
	5	0.50	±0.05		S	1.35	±0.15
0603(1608)	5	0.50	+0.0/-0.1*		H	1.60	±0.20
	8	0.80	±0.10		U	1.80	±0.20*
0805(2012)	A	0.65	±0.10		I	2.00	±0.20
	C	0.85	±0.10		J	2.50	±0.20
	C	0.85	±0.10*		V	2.50	±0.30
	M	1.15	±0.10		1808(4520)	F	1.25
	F	1.25	±0.10	H		1.60	±0.20
	Q	1.25	±0.15	I		2.00	±0.20
	Y	1.25	±0.20	F		1.25	±0.20
1206(3216)	C	0.85	±0.15	1812(4532)	H	1.60	±0.20
	C	0.85	±0.10*		I	2.00	±0.20
	E	1.10	±0.15		J	2.50	±0.20
	E	1.10	±0.10*	2220(5750)	L	3.20	±0.30
	P	1.15	±0.10*		H	1.60	±0.20
	M	1.15	±0.15		I	2.00	±0.20
	F	1.25	±0.15		J	2.50	±0.20
	H	1.60	±0.20		L	3.00	±0.30

Note: (*) Mark is only applicable to Design Code "L", 16th digit in part number (17th digit if 01005 size).

8) Packaging Code

B = Bulk
 C = Cardboard Tape, 7"Reel
 D = Cardboard Tape, 13"Reel (10,000ea)
 E = Embossed Type, 7"Reel
 F = Embossed Type, 13"Reel
 O = Cardboard Tape, 10"Reel

G = Embossed Type, 7"Reel (3,000ea)
 H = Cardboard Tape, 7"Reel (15,000ea)
 L = Cardboard Tape, 13"Reel (15,000ea)
 P = Bulk Case
 S = Embossed Type, 10"Reel
 Y = Cardboard Tape, 7"Reel (Chip aligned for vertical SMT)
 Z = Cardboard Type, 7"Reel (Chip aligned for horizontal SMT)

9) Product Code:

N = Normal
 A = For Automotive use (Product meets AEC-Q-200 specs)
 4 = High Reliability Industrial
 L = LICC (Low Inductance Ceramic Capacitors)
 J = SLIC (Super Low Inductance Capacitors)

S, Q, R, U, Z, 9 = alternate size tolerance (see table)

Size Inch (mm)	01005(0402)	0201(0603)	0402(1005)	0603(1608)	0805(2012)	1206(3216)
Code						
S	±0.03	±0.05	±0.07	±0.07		±0.30
Q	±0.05	±0.07	±0.10	±0.15	±0.15	
R	±0.07	±0.09	±0.15	±0.20	±0.20	
U	±0.09		±0.20	±0.25	±0.30	
Z			±0.40	±0.30		
9			±0.30			

10) Design Code:

A = Normal Product Pd / Ag / Ni barrier / Sn 100%
 N = Normal Product Ni / Cu / Ni barrier / Sn 100%
 G = Normal Product Cu / Cu / Ni barrier / Sn 100%
 L = Low profile Ni / Cu / Ni barrier / Sn 100%
 S = Normal Product Ni/Cu/Soft termination /Ni barrier /Sn100%

1 = Ni/Cu/Ni Barrier/Sn 100%/Standard (for Automotive use)
 V = Ni/Cu+Soft termination/Ni Barrier/Sn 100%/Standard (for Automotive use)
 W = Ni/Cu+Soft termination/Ni Barrier/Sn 100%/Open Mode (for Automotive use)
 Z = Ni/Soft termination/Sn 100% (for High Reliability Industrial use)

11) Control Code

S= Standard
 I= Industrial

MultiLayer Ceramic Capacitors

Standard & High Capacitors

Features

- Wide capacitance range.
- Highly reliable tolerance and high speed automatic chip placement on PCBs.
- Wide selection of size: from 0402 to 2220.
- Wide temperature compensation and voltage range:
From C0G to Y5V and from 6.3V to 50V
- Highly reliable performance
- Highly resistant termination metal
- Tape & reel for surface mount assembly
- RoHS compliant.

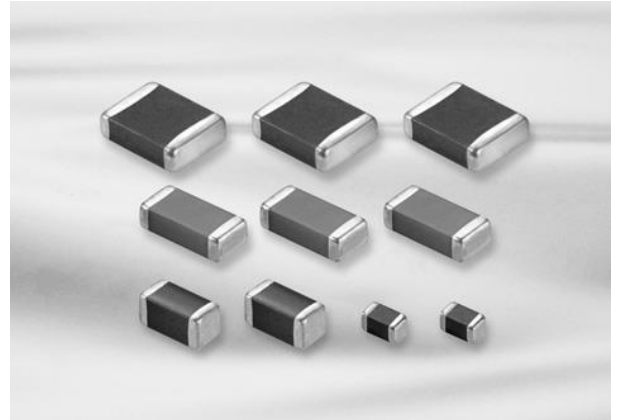

❖ Application

- HHP, DSC, DVC, LCD, TV, Memory Module, PDA, Game Machine.
- Desktop PC, Note PC, HHP, DC-DC Converter, DSC
- Tuner (Product code C is suitable.).

❖ Structure and Dimensions

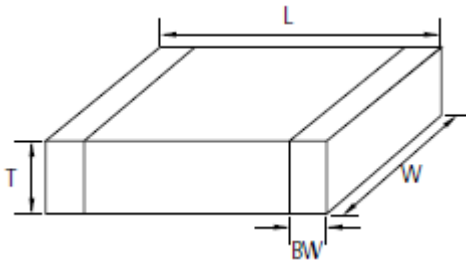

EIA Code (Inch)	Dimension(mm)				
	L	W	T	Thickness Code	BW
0402	1.00±0.05	0.50±0.05	0.50±0.05	5	0.25±0.10
0603	1.60±0.10	0.80±0.10	0.50±0.0/-0.1(*)	5	0.30±0.20
	1.60±0.10	0.80±0.10	0.80±0.10	8	

EIA Code (Inch)	Dimension(mm)				
	L	W	T	Thickness Code	BW
0805	2.00±0.10	1.25±0.10	0.85±0.10	C	0.5±0.2/ 0.3
	2.00±0.10	1.25±0.10	1.15±0.10	M	
	2.00±0.10	1.25±0.10	1.25±0.10	F	
	2.00±0.15	1.25±0.15	1.25±0.15	Q	
	2.00±0.20	1.25±0.20	1.25±0.20	Y	
1206	3.20±0.20	1.60±0.20	0.60±0.10(*)	6	0.50±0.30
	3.20±0.15	1.60±0.15	0.85±0.15	C	
	3.20±0.20	1.60±0.20	0.85±0.10(*)	C	
	3.20±0.20	1.60±0.20	1.15±0.10(*)	P	
	3.20±0.15	1.60±0.15	1.25±0.15	F	
1210	3.20±0.20	1.60±0.20	1.60±0.20	H	0.60±0.30
	3.20±0.30	2.50±0.20	0.85±0.10(*)	C	
	3.20±0.30	2.50±0.20	0.90±0.10(*)	9	
	3.20±0.30	2.50±0.20	1.60±0.20	H	
	3.20±0.30	2.50±0.20	1.80±0.20(*)	U	
	3.20±0.30	2.50±0.20	2.00±0.20	I	
	3.20±0.30	2.50±0.20	2.50±0.20	J	
3.20±0.40	2.50±0.30	2.50±0.30	V		
1808	4.50±0.40	2.00±0.20	1.25±0.20	F	0.80±0.30
	4.50±0.40	2.00±0.20	1.40±0.20	G	
	4.50±0.40	2.00±0.20	2.00±0.20	I	
1812	4.50±0.40	3.20±0.30	1.25±0.20	F	0.80±0.30
	4.50±0.40	3.20±0.30	2.50±0.20	J	
	4.50±0.40	3.20±0.30	3.20±0.30	L	
2220	5.70±0.40	5.00±0.40	2.50±0.20	J	1.00±0.30
	5.70±0.40	5.00±0.40	3.20±0.30	L	

Note: (*) Mark is only applicable to Design Code "L", 16th digit in part number (17th digit if 01005 size).

❖ Standard & High Capacitance (C0G)

Size Inch (mm)	Vr (V)	Capacitance																								
		p										nF														
		0.5	1	10	22	47	100	220	330	470	560	1	2.2	3.3	4.7	6.8	10	22	27	33	47	68	100	120	150	
0402 (1005)	25																									
	50																									
0603 (1608)	25																									
	50																									
0805 (2012)	25																									
	50																									
1206 (3216)	16																									
	25																									
1210	50																									
	50																									
1812	25																									
	50																									
2220 (5750)	50																									
	50																									

❖ Standard & High Capacitance (X5R)

Size Inch (mm)	Vr (V)	Capacitance(μF)										
		0.1	0.22	0.47	1	2.2	4.7	10	22	47	100	220
0402(1005)	4								15			
	6.3											
	10											
	16											
	25											
0603(1608)	4											
	6.3											
	10											
	16											
	25											
0805(2012)	4											
	6.3											
	10											
	16											
	25											
1206(3216)	50											
	6.3										150	
	10											
	16											
	25											
1210(3225)	50											
	6.3											
	10											
	16											
	25											

❖ Standard & High Capacitance-Low Profile (X5R)

Size Inch (mm)	Tmax (mm)	Vr (V)	Capacitance(μF)					
			1	2.2	4.7	10	22	47
0402(1005)	0.33	6.3	X6S		(Tmax=0.35)			
		10						
		16						
0603(1608)	0.5	6.3						
		10						
		16						
		25						
0805(2012)	0.7	10						
		16						
		25						
	0.85	25						
		4					(Tmax=1.0)	
		6.3					(Tmax=1.0)	
0.95	10							
	16							
	25				X6S			
	50							
1206(3216)	0.95	10						
		6.3						
		10						
		16						
		25						
1210(3225)	0.95	50		(Tmax=1.0)	(Tmax=1.0)			
		100		(Tmax=1.0)				
		16						
2.0	25							
	35							
	50							

❖ Standard & High Capacitance (X6S)

Size Inch (mm)	Vr (V)	Capacitance(μF)									
		0.1	0.22	0.47	1	2.2	4.7	10	22	47	100
0402(1005)	4										
	6.3										
	10										
0603(1608)	4										
	6.3										
	10										
	16										
0805(2012)	25										
	4										
	6.3										
	10										
1206(3216)	16										
	25										
	6.3										
	10										
1210(3225)	16										
	25										
	6.3										
	10										

❖ Standard & High Capacitance (X7R)

Size Inch (mm)	Vr (V)	Capacitance(μF)									
		0.1	0.22	0.47	1	2.2	4.7	10	22	47	100
0402(1005)	6.3										
	10			X7S							
	16										
0603(1608)	6.3										
	10										
	16										
	25										
0805(2012)	50										
	6.3										
	10										
	16										
	25						X7S				
1206(3216)	35										
	50										
	6.3										
	10										
	16										
1210(3225)	25										
	35										
	50										
	6.3										X7T
	10										

❖ Standard & High Capacitance (Y5V)

Size Inch (mm)	Vr (V)	Capacitance(uF)								
		0.1	0.22	0.47	1	2.2	4.7	10	22	47
0402(1005)	6.3									
	10									
	16									
	25									
0603(1608)	6.3									
	10									
	16									
	25									
0805(2012)	6.3									
	10									
	16									
	25									
1206(3216)	50									
	10									
	16									
	25									
1210(3225)	50				(Tmax=1.35)					
	6.3									
	10								(Tmax=2.7)	
	16							(Tmax=1.2)	(Tmax=2.0)	
	25							(Tmax=1.8)		
	35							(Tmax=1.5)		
1210(3225)	35							(Tmax=1.4)		
	50							(Tmax=1.6)		
	50				(Tmax=1.45)					

❖ Standard & High capacitance - Low Profile (Y5V)

Size Inch (mm)	Vr (V)	Capacitance(uF)					
		1	2.2	4.7	10	22	47
0805(2012)	6.3				(Tmax=0.95)		
	10				(Tmax=0.95)		

❖ Product Lineup (Standard & High capacitors - C0G)

Part Number	Size LxW (mm)	Capacitance	Rated Voltage (Vdc)	Capacitance Tolerance	Thickness Max. (mm)
XC0402C0R5CB5*NN-S	1.00x0.50	0.5pF	50	±0.25pF	0.55
XC0402CR75CB5*NN-S		0.75pF	50	±0.25pF	0.55
XC0402C010CB5*NN-S		1.0pF	50	±0.25pF	0.55
XC0402C1R2CB5*NN-S		1.2pF	50	±0.25pF	0.55
XC0402C1R5CB5*NN-S		1.5pF	50	±0.25pF	0.55
XC0402C1R8CB5*NN-S		1.8pF	50	±0.25pF	0.55
XC0402C020CB5*NN-S		2.0pF	50	±0.25pF	0.55
XC0402C2R2CB5*NN-S		2.2pF	50	±0.25pF	0.55
XC0402C2R4CB5*NN-S		2.4pF	50	±0.25pF	0.55
XC0402C2R5CB5*NN-S		2.5pF	50	±0.25pF	0.55
XC0402C2R7CB5*NN-S		2.7pF	50	±0.25pF	0.55
XC0402C030CB5*NN-S		3.0pF	50	±0.25pF	0.55
XC0402C3R3CB5*NN-S		3.3pF	50	±0.25pF	0.55
XC0402C3R5CB5*NN-S		3.5pF	50	±0.25pF	0.55
XC0402C3R6CB5*NN-S		3.6pF	50	±0.25pF	0.55
XC0402C3R9CB5*NN-S		3.9pF	50	±0.25pF	0.55
XC0402C040CB5*NN-S		4.0pF	50	±0.25pF	0.55
XC0402C4R3CB5*NN-S		4.3pF	50	±0.25pF	0.55
XC0402C4R7CB5*NN-S		4.7pF	50	±0.25pF	0.55
XC0402C050DB5*NN-S		5.0pF	50	±0.5pF	0.55
XC0402C5R6DB5*NN-S		5.6pF	50	±0.5pF	0.55
XC0402C060DB5*NN-S		6.0pF	50	±0.5pF	0.55
XC0402C6R2DB5*NN-S		6.2pF	50	±0.5pF	0.55
XC0402C6R8DB5*NN-S		6.8pF	50	±0.5pF	0.55
XC0402C070DB5*NN-S		7.0pF	50	±0.5pF	0.55
XC0402C080DB5*NN-S		8.0pF	50	±0.5pF	0.55
XC0402C8R2DB5*NN-S		8.2pF	50	±0.5pF	0.55
XC0402C090DB5*NN-S		9.0pF	50	±0.5pF	0.55
XC0402C9R1DB5*NN-S		9.1pF	50	±0.5pF	0.55
XC0402C100JB5*NN-S		10pF	50	±5%	0.55
XC0402C110JB5*NN-S		11pF	50	±5%	0.55
XC0402C120JB5*NN-S		12pF	50	±5%	0.55
XC0402C130JB5*NN-S		13pF	50	±5%	0.55
XC0402C150JB5*NN-S		15pF	50	±5%	0.55
XC0402C160JB5*NN-S		16pF	50	±5%	0.55
XC0402C180JB5*NN-S		18pF	50	±5%	0.55
XC0402C200JB5*NN-S		20pF	50	±5%	0.55
XC0402C220JA5*NN-S		22pF	25	±5%	0.55
XC0402C220JB5*NN-S		22pF	50	±5%	0.55
XC0402C240JB5*NN-S		24pF	50	±5%	0.55
XC0402C270JB5*NN-S		27pF	50	±5%	0.55
XC0402C270JA5*NN-S		27pF	25	±5%	0.55
XC0402C300JB5*NN-S		30pF	50	±5%	0.55
XC0402C330JB5*NN-S		33pF	50	±5%	0.55
XC0402C360JB5*NN-S		36pF	50	±5%	0.55
XC0402C390JB5*NN-S		39pF	50	±5%	0.55
XC0402C430JB5*NN-S		43pF	50	±5%	0.55
XC0402C470JB5*NN-S		47pF	50	±5%	0.55
XC0402C510JB5*NN-S		51pF	50	±5%	0.55
XC0402C560JB5*NN-S		56pF	50	±5%	0.55

Note: (*) Represents Packaging Code

Part Number	Size LxW (mm)	Capacitance	Rated Voltage (Vdc)	Capacitance Tolerance	Thickness Max. (mm)	
XC0402C620JB5*NN-S	1.00x0.50	62pF	50	±5%	0.55	
XC0402C680JB5*NN-S		68pF	50	±5%	0.55	
XC0402C750JB5*NN-S		75pF	50	±5%	0.55	
XC0402C820JB5*NN-S		82pF	50	±5%	0.55	
XC0402C910JB5*NN-S		91pF	50	±5%	0.55	
XC0402C101JB5*NN-S		100pF	50	±5%	0.55	
XC0402C121JB5*NN-S		120pF	50	±5%	0.55	
XC0402C151JB5*NN-S		150pF	50	±5%	0.55	
XC0402C181JB5*NN-S		180pF	50	±5%	0.55	
XC0402C201JB5*NN-S		200pF	50	±5%	0.55	
XC0402C221JB5*NN-S		220pF	50	±5%	0.55	
XC0402C271JB5*NN-S		270pF	50	±5%	0.55	
XC0402C331JB5*NN-S		330pF	50	±5%	0.55	
XC0402C391JB5*NN-S		390pF	50	±5%	0.55	
XC0402C471JB5*NN-S		470pF	50	±5%	0.55	
XC0402C471JO5*NN-S		470pF	16	±5%	0.55	
XC0402C681JB5*NN-S		680pF	50	±5%	0.55	
XC0402C821JB5*NN-S		820pF	50	±5%	0.55	
XC0402C102JB5*NN-S		1nF	50	±5%	0.55	
XC0402C102JA5*NN-S		1nF	25	±5%	0.55	
XC0402C102JO5*NN-S		1nF	16	±5%	0.55	
XC0603C0R3CB8*NN-S		1.60x0.80	0.3pF	50	±0.25pF	0.90
XC0603C0R5CB8*NN-S			0.5pF	50	±0.25pF	0.90
XC0603CR75CB8*NN-S			0.75pF	50	±0.25pF	0.90
XC0603C010CB8*NN-S			1.0pF	50	±0.25pF	0.90
XC0603C1R2CB8*NN-S			1.2pF	50	±0.25pF	0.90
XC0603C1R5CB8*NN-S			1.5pF	50	±0.25pF	0.90
XC0603C1R8CB8*NN-S			1.8pF	50	±0.25pF	0.90
XC0603C020CB8*NN-S	2.0pF		50	±0.25pF	0.90	
XC0603C2R2CB8*NN-S	2.2pF		50	±0.25pF	0.90	
XC0603C2R4CB8*NN-S	2.4pF		50	±0.25pF	0.90	
XC0603C2R5CB8*NN-S	2.5pF		50	±0.25pF	0.90	
XC0603C2R7CB8*NN-S	2.7pF		50	±0.25pF	0.90	
XC0603C030CB8*NN-S	3.0pF		50	±0.25pF	0.90	
XC0603C3R3CB8*NN-S	3.3pF		50	±0.25pF	0.90	
XC0603C3R5CB8*NN-S	3.5pF		50	±0.25pF	0.90	
XC0603C3R6CB8*NN-S	3.6pF		50	±0.25pF	0.90	
XC0603C3R9CB8*NN-S	3.9pF		50	±0.25pF	0.90	
XC0603C040CB8*NN-S	4.0pF		50	±0.25pF	0.90	
XC0603C4R3CB8*NN-S	4.3pF		50	±0.25pF	0.90	
XC0603C4R7CB8*NN-S	4.7pF		50	±0.25pF	0.90	
XC0603C050DB8*NN-S	5.0pF		50	±0.5pF	0.90	
XC0603C5R6DB8*NN-S	5.6pF		50	±0.5pF	0.90	
XC0603C060DB8*NN-S	6.0pF		50	±0.5pF	0.90	
XC0603C6R2DB8*NN-S	6.2pF		50	±0.5pF	0.90	
XC0603C6R8DB8*NN-S	6.8pF		50	±0.5pF	0.90	
XC0603C070DB8*NN-S	7.0pF		50	±0.5pF	0.90	
XC0603C7R5DB8*NN-S	7.5pF		50	±0.5pF	0.90	
XC0603C080DB8*NN-S	8.0pF		50	±0.5pF	0.90	
XC0603C8R2DB8*NN-S	8.2pF		50	±0.5pF	0.90	
XC0603C090DB8*NN-S	9.0pF		50	±0.5pF	0.90	
XC0603C9R1DB8*NN-S	9.1pF		50	±0.5pF	0.90	
XC0603C100JB8*NN-S	10pF		50	±5%	0.90	
XC0603C110JB8*NN-S	11pF		50	±5%	0.90	
XC0603C120JB8*NN-S	12pF		50	±5%	0.90	
XC0603C130JB8*NN-S	13pF		50	±5%	0.90	
XC0603C140JB8*NN-S	14pF		50	±5%	0.90	

Part Number	Size LxW (mm)	Capacitance	Rated Voltage (Vdc)	Capacitance Tolerance	Thickness Max. (mm)
XC0603C150JB8*NN-S	1.60x0.80	15pF	50	±5%	0.90
XC0603C160JB8*NN-S		16pF	50	±5%	0.90
XC0603C180JB8*NN-S		18pF	50	±5%	0.90
XC0603C200JB8*NN-S		20pF	50	±5%	0.90
XC0603C220JB8*NN-S		22pF	50	±5%	0.90
XC0603C240JB8*NN-S		24pF	50	±5%	0.90
XC0603C250JB8*NN-S		25pF	50	±5%	0.90
XC0603C270JB8*NN-S		27pF	50	±5%	0.90
XC0603C300JB8*NN-S		30pF	50	±5%	0.90
XC0603C330JB8*NN-S		33pF	50	±5%	0.90
XC0603C360JB8*NN-S		36pF	50	±5%	0.90
XC0603C390JB8*NN-S		39pF	50	±5%	0.90
XC0603C430JB8*NN-S		43pF	50	±5%	0.90
XC0603C470JB8*NN-S		47pF	50	±5%	0.90
XC0603C510JB8*NN-S		51pF	50	±5%	0.90
XC0603C560JB8*NN-S		56pF	50	±5%	0.90
XC0603C620JB8*NN-S		62pF	50	±5%	0.90
XC0603C680JB8*NN-S		68pF	50	±5%	0.90
XC0603C750JB8*NN-S		75pF	50	±5%	0.90
XC0603C820JB8*NN-S		82pF	50	±5%	0.90
XC0603C910JB8*NN-S		91pF	50	±5%	0.90
XC0603C101JB8*NN-S		100pF	50	±5%	0.90
XC0603C111JB8*NN-S		110pF	50	±5%	0.90
XC0603C121JB8*NN-S		120pF	50	±5%	0.90
XC0603C131JB8*NN-S		130pF	50	±5%	0.90
XC0603C151JB8*NN-S		150pF	50	±5%	0.90
XC0603C161JB8*NN-S		160pF	50	±5%	0.90
XC0603C181JB8*NN-S		180pF	50	±5%	0.90
XC0603C201JB8*NN-S		200pF	50	±5%	0.90
XC0603C221JB8*NN-S		220pF	50	±5%	0.90
XC0603C241JB8*NN-S		240pF	50	±5%	0.90
XC0603C271JB8*NN-S		270pF	50	±5%	0.90
XC0603C301JB8*NN-S		300pF	50	±5%	0.90
XC0603C331JB8*NN-S		330pF	50	±5%	0.90
XC0603C361JB8*NN-S		360pF	50	±5%	0.90
XC0603C391JB8*NN-S		390pF	50	±5%	0.90
XC0603C431JB8*NN-S		430pF	50	±5%	0.90
XC0603C471JB8*NN-S		470pF	50	±5%	0.90
XC0603C511JB8*NN-S		510pF	50	±5%	0.90
XC0603C561JB8*NN-S		560pF	50	±5%	0.90
XC0603C621JB8*NN-S	620pF	50	±5%	0.90	
XC0603C681JB8*NN-S	680pF	50	±5%	0.90	
XC0603C751JB8*NN-S	750pF	50	±5%	0.90	
XC0603C821JB8*NN-S	820pF	50	±5%	0.90	
XC0603C102JB8*NN-S	1nF	50	±5%	0.90	
XC0603C182JB8*NN-S	1.8nF	50	±5%	0.90	
XC0603C222JB8*NN-S	2.2nF	50	±5%	0.90	
XC0603C562JB8*NN-S	5.6nF	50	±5%	0.90	
XC0603C103JA8*NN-S	10nF	25	±5%	0.90	

Note: (*) Represents Packaging Code

Part Number	Size LxW (mm)	Capacitance	Rated Voltage (Vdc)	Capacitance Tolerance	Thickness Max. (mm)
XC0805CR47CBA*NN-S	2.00x1.25	0.47pF	50	±0.25pF	0.75
XC0805C0R5CBA*NN-S		0.5pF	50	±0.25pF	0.75
XC0805C010CBA*NN-S		1.0pF	50	±0.25pF	0.75
XC0805C1R2CBA*NN-S		1.2pF	50	±0.25pF	0.75
XC0805C1R5CBA*NN-S		1.5pF	50	±0.25pF	0.75
XC0805C1R8CBA*NN-S		1.8pF	50	±0.25pF	0.75
XC0805C020CBA*NN-S		2.0pF	50	±0.25pF	0.75
XC0805C2R2CBA*NN-S		2.2pF	50	±0.25pF	0.75
XC0805C2R4CBA*NN-S		2.4pF	50	±0.25pF	0.75
XC0805C2R5CBA*NN-S		2.5pF	50	±0.25pF	0.75
XC0805C2R7CBA*NN-S		2.7pF	50	±0.25pF	0.75
XC0805C030CBA*NN-S		3.0pF	50	±0.25pF	0.75
XC0805C3R2CBA*NN-S		3.2pF	50	±0.25pF	0.75
XC0805C3R3CBA*NN-S		3.3pF	50	±0.25pF	0.75
XC0805C3R6CBA*NN-S		3.6pF	50	±0.25pF	0.75
XC0805C3R9CBA*NN-S		3.9pF	50	±0.25pF	0.75
XC0805C040CBA*NN-S		4.0pF	50	±0.25pF	0.75
XC0805C4R7CBA*NN-S		4.7pF	50	±0.25pF	0.75
XC0805C5R6DBA*NN-S		5.6pF	50	±0.5pF	0.75
XC0805C060DBA*NN-S		6.0pF	50	±0.5pF	0.75
XC0805C6R8DBA*NN-S		6.8pF	50	±0.5pF	0.75
XC0805C070DBA*NN-S		7.0pF	50	±0.5pF	0.75
XC0805C7R5DBA*NN-S		7.5pF	50	±0.5pF	0.75
XC0805C080DBA*NN-S		8.0pF	50	±0.5pF	0.75
XC0805C8R2DBA*NN-S		8.2pF	50	±0.5pF	0.75
XC0805C090DBA*NN-S		9.0pF	50	±0.5pF	0.75
XC0805C100JBA*NN-S		10pF	50	±5%	0.75
XC0805C120JBA*NN-S		12pF	50	±5%	0.75
XC0805C130JBA*NN-S		13pF	50	±5%	0.75
XC0805C140JBA*NN-S		14pF	50	±5%	0.75
XC0805C150JBA*NN-S		15pF	50	±5%	0.75
XC0805C160JBA*NN-S		16pF	50	±5%	0.75
XC0805C180JBA*NN-S		18pF	50	±5%	0.75
XC0805C200JBA*NN-S		20pF	50	±5%	0.75
XC0805C220JBA*NN-S		22pF	50	±5%	0.75
XC0805C240JBA*NN-S		24pF	50	±5%	0.75
XC0805C250JBA*NN-S		25pF	50	±5%	0.75
XC0805C270JBA*NN-S		27pF	50	±5%	0.75
XC0805C300JBA*NN-S		30pF	50	±5%	0.75
XC0805C330JBA*NN-S		33pF	50	±5%	0.75
XC0805C360JBA*NN-S		36pF	50	±5%	0.75
XC0805C390JBA*NN-S		39pF	50	±5%	0.75
XC0805C430JBA*NN-S		43pF	50	±5%	0.75
XC0805C470JBA*NN-S		47pF	50	±5%	0.75
XC0805C510JBA*NN-S		51pF	50	±5%	0.75
XC0805C560JBA*NN-S		56pF	50	±5%	0.75
XC0805C620JBA*NN-S		62pF	50	±5%	0.75
XC0805C680JBA*NN-S		68pF	50	±5%	0.75
XC0805C750JBA*NN-S		75pF	50	±5%	0.75
XC0805C820JBA*NN-S		82pF	50	±5%	0.75
XC0805C910JBA*NN-S		91pF	50	±5%	0.75
XC0805C101JBA*NN-S		100pF	50	±5%	0.75
XC0805C111JBA*NN-S		110pF	50	±5%	0.75
XC0805C121JBA*NN-S		120pF	50	±5%	0.75
XC0805C131JBA*NN-S		130pF	50	±5%	0.75
XC0805C151JBA*NN-S		150pF	50	±5%	0.75
XC0805C161JBA*NN-S		160pF	50	±5%	0.75

Note: (*) Represents Packaging Code

Part Number	Size LxW (mm)	Capacitance	Rated Voltage (Vdc)	Capacitance Tolerance	Thickness Max. (mm)	
XC0805C181JBA*NN-S	2.00x1.25	180pF	50	+5%	0.75	
XC0805C201JBA*NN-S		200pF	50	+5%	0.75	
XC0805C221JBA*NN-S		220pF	50	+5%	0.75	
XC0805C241JBA*NN-S		240pF	50	+5%	0.75	
XC0805C271JBA*NN-S		270pF	50	+5%	0.75	
XC0805C301JBA*NN-S		300pF	50	+5%	0.75	
XC0805C331JBA*NN-S		330pF	50	+5%	0.75	
XC0805C361JBA*NN-S		360pF	50	+5%	0.75	
XC0805C391JBA*NN-S		390pF	50	+5%	0.75	
XC0805C431JBA*NN-S		430pF	50	+5%	0.75	
XC0805C471JBA*NN-S		470pF	50	+5%	0.75	
XC0805C511JBA*NN-S		510pF	50	+5%	0.75	
XC0805C561JBA*NN-S		560pF	50	+5%	0.75	
XC0805C621JBC*NN-S		620pF	50	+5%	0.95	
XC0805C681JBC*NN-S		680pF	50	+5%	0.95	
XC0805C751JBC*NN-S		750pF	50	+5%	0.95	
XC0805C821JBC*NN-S		820pF	50	+5%	0.95	
XC0805C102JBC*NN-S		1nF	50	+5%	0.95	
XC0805C122JBF*NN-S		1.2nF	50	+5%	1.35	
XC0805C152JBF*NN-S		1.5nF	50	+5%	1.35	
XC0805C182JBF*NN-S		1.8nF	50	+5%	1.35	
XC0805C222JBF*NN-S		2.2nF	50	+5%	1.35	
XC0805C332JAF*NN-S		3.3nF	25	+5%	1.35	
XC0805C332JBF*NN-S		3.3nF	50	+5%	1.35	
XC0805C392JAA*NN-S		3.9nF	25	+5%	0.75	
XC0805C392JBF*NN-S		3.9nF	50	+5%	1.35	
XC0805C472JBF*NN-S		4.7nF	50	+5%	1.35	
XC0805C562JBF*NN-S		5.6nF	50	+5%	1.35	
XC0805C822JAF*NN-S		8.2nF	25	+5%	1.35	
XC0805C103JBF*NN-S		10nF	50	+5%	1.35	
XC0805C333JAF*NN-S		33nF	25	+5%	1.35	
XC1206C0R5CBC*NN-S		3.20x1.60	0.5pF	50	+0.25pF	1.0
XC1206C010CBC*NN-S			1.0pF	50	+0.25pF	1.0
XC1206C1R5CBC*NN-S	1.5pF		50	+0.25pF	1.0	
XC1206C1R8CBC*NN-S	1.8pF		50	+0.25pF	1.0	
XC1206C020CBC*NN-S	2.0pF		50	+0.25pF	1.0	
XC1206C2R2CBC*NN-S	2.2pF		50	+0.25pF	1.0	
XC1206C2R7CBC*NN-S	2.7pF		50	+0.25pF	1.0	
XC1206C030CBC*NN-S	3.0pF		50	+0.25pF	1.0	
XC1206C3R3CBC*NN-S	3.3pF		50	+0.25pF	1.0	
XC1206C040CBC*NN-S	4.0pF		50	+0.25pF	1.0	
XC1206C4R7CBC*NN-S	4.7pF		50	+0.25pF	1.0	
XC1206C100JBC*NN-S	10pF		50	+5%	1.0	
XC1206C120JBC*NN-S	12pF		50	+5%	1.0	
XC1206C150JBC*NN-S	15pF		50	+5%	1.0	
XC1206C180JBC*NN-S	18pF		50	+5%	1.0	
XC1206C200JBC*NN-S	20pF		50	+5%	1.0	
XC1206C220JBC*NN-S	22pF		50	+5%	1.0	
XC1206C270JBC*NN-S	27pF		50	+5%	1.0	
XC1206C300JBC*NN-S	30pF		50	+5%	1.0	
XC1206C330JBC*NN-S	33pF		50	+5%	1.0	
XC1206C390JBC*NN-S	39pF		50	+5%	1.0	
XC1206C470JBC*NN-S	47pF		50	+5%	1.0	

Note: (*) Represents Packaging Code

Part Number	Size LxW (mm)	Capacitance	Rated Voltage (Vdc)	Capacitance Tolerance	Thickness Max. (mm)
XC1206C510JBC*NN-S	3.20x1.60	51pF	50	±5%	1.0
XC1206C560JBC*NN-S		56pF	50	±5%	1.0
XC1206C680JBC*NN-S		68pF	50	±5%	1.0
XC1206C750JBC*NN-S		75pF	50	±5%	1.0
XC1206C820JBC*NN-S		82pF	50	±5%	1.0
XC1206C101JBC*NN-S		100pF	50	±5%	1.0
XC1206C121JBC*NN-S		120pF	50	±5%	1.0
XC1206C151JBC*NN-S		150pF	50	±5%	1.0
XC1206C181JBC*NN-S		180pF	50	±5%	1.0
XC1206C221JBC*NN-S		220pF	50	±5%	1.0
XC1206C271JBC*NN-S		270pF	50	±5%	1.0
XC1206C331JBC*NN-S		330pF	50	±5%	1.0
XC1206C391JBC*NN-S		390pF	50	±5%	1.0
XC1206C471JBC*NN-S		470pF	50	±5%	1.0
XC1206C561JBC*NN-S		560pF	50	±5%	1.0
XC1206C681JBC*NN-S		680pF	50	±5%	1.0
XC1206C821JBC*NN-S		820pF	50	±5%	1.0
XC1206C102JBC*NN-S		1nF	50	±5%	1.0
XC1206C122JBC*NN-S		1.2nF	50	±5%	1.0
XC1206C152JBC*NN-S		1.5nF	50	±5%	1.0
XC1206C182JBC*NN-S		1.8nF	50	±5%	1.0
XC1206C222JBC*NN-S		2.2nF	50	±5%	1.0
XC1206C272JBF*NN-S		2.7nF	50	±5%	1.4
XC1206C332JBF*NN-S		3.3nF	50	±5%	1.4
XC1206C472JBF*NN-S		4.7nF	50	±5%	1.4
XC1206C682JBH*NN-S		6.8nF	50	±5%	1.8
XC1206C103JAF*NN-S		10nF	25	±5%	1.4
XC1206C223JBH*NN-S		22nF	50	±5%	1.8
XC1206C333JBH*NN-S		33nF	50	±5%	1.8
XC1206C473JBH*NN-S		47nF	50	±5%	1.8
XC1206C683JAH*NN-S		68nF	25	±5%	1.8
XC1206C104JAH*NN-S		100nF	25	±5%	1.8
XC1210C472JBF*NN-S		3.20x2.50	4.7nF	50	±5%
XC1210C103JBF*NN-S	10nF		50	±5%	1.45
XC1210C223JBH*NN-S	22nF		50	±5%	1.80
XC1210C333JBH*NN-S	33nF		50	±5%	1.8
XC1210C473JBH*NN-S	47nF		50	±5%	1.8

Note: (*) Represents Packaging Code

❖ Product Lineup (Standard & High Capacitors-X5R)

Part Number	Size LxW (mm)	Capacitance	Rated Voltage (Vdc)	Capacitance Tolerance	Thickness Max. (mm)
XC0402A223KO5*NN-S	1.00x0.50	22nF	16	±10%	0.55
XC0402A104KA5*NN-S		0.1uF	25	±10%	0.55
XC0402A104KO5*NN-S		0.1uF	16	±10%	0.55
XC0402A104KP5*NN-S		0.1uF	10	±10%	0.55
XC0402A224KA5*NN-S		0.22uF	25	±10%	0.55
XC0402A224KP5*NN-S		0.22uF	10	±10%	0.55
XC0402A334KA5*NN-S		0.33uF	25	±10%	0.55
XC0402A334KP5*NN-S		0.33uF	10	±10%	0.55
XC0402A474KA5*NN-S		0.47uF	25	±10%	0.55
XC0402A474KO5*NN-S		0.47uF	16	±10%	0.55
XC0402A474KP5*NN-S		0.47uF	10	±10%	0.55
XC0402A474KQ5*NN-S		0.47uF	6.3	±10%	0.55
XC0402A474KR5*NN-S		0.47uF	4	±10%	0.55
XC0402A105KA5*QN-S		1uF	25	±10%	0.60
XC0402A105KO5*NN-S		1uF	16	±10%	0.55
XC0402A105KO3*QL-S		1uF	16	±10%	0.33
XC0402A105KP5*NN-S		1uF	10	±10%	0.55
XC0402A105KP3*NL-S		1uF	10	±10%	0.33
XC0402A105KQ5*NN-S		1uF	6.3	±10%	0.55
XC0402A105KQ3*NL-S		1uF	6.3	±10%	0.33
XC0402A105KR5*NN-S		1uF	4	±10%	0.55
XC0402A105KR3*NL-S		1uF	4	±10%	0.33
XC0402A225MA5*UN-S		2.2uF	25	±20%	0.70
XC0402A225KO5*QN-S		2.2uF	16	±10%	0.60
XC0402A225MP5*SN-S		2.2uF	10	±20%	0.57
XC0402A225KP3*RL-S		2.2uF	10	±10%	0.33
XC0402A225MQ5*NN-S		2.2uF	6.3	±20%	0.55
XC0402A225KQ3*RL-S		2.2uF	6.3	±10%	0.33
XC0402A225MR5*NN-S		2.2uF	4	±20%	0.55
XC0402A225KR3*RL-S		2.2uF	4	±10%	0.33
XC0402A475MO5*UN-S		4.7uF	16	±20%	0.70
XC0402A475MP5*RN-S		4.7uF	10	±20%	0.65
XC0402A475MQ5*RN-S		4.7uF	6.3	±20%	0.65
XC0402A475MQ3*UL-S		4.7uF	6.3	±20%	0.35
XC0402A106MP5*UN-S		10uF	10	±20%	0.70
XC0402A106MQ5*UN-S		10uF	6.3	±20%	0.70
XC0402A106MR5*RN-S		10uF	4	±20%	0.65
XC0402A156MR5*UN-S		15uF	4	±20%	0.70
XC0402A226MR5*ZN-S		22uF	4	±20%	0.90
XC0603A474KB8*NN-S		1.60x0.80	0.47uF	50	±10%
XC0603A474KA8*NN-S	0.47uF		25	±10%	0.90
XC0603A474KP8*NN-S	0.47uF		10	±10%	0.90
XC0603A474KQ8*NN-S	0.47uF		6.3	±10%	0.90
XC0603A474KR8*NN-S	0.47uF		4	±10%	0.90
XC0603A105KB8*NN-S	1uF		50	±10%	0.90
XC0603A105KA5*NL-S	1uF		25	±10%	0.50
XC0603A105KA8*NN-S	1uF		25	±10%	0.90
XC0603A105KO8*NN-S	1uF		16	±10%	0.90
XC0603A105KO5*NL-S	1uF		16	±10%	0.50
XC0603A105KP8*NN-S	1uF		10	±10%	0.90
XC0603A105KP5*NL-S	1uF		10	±10%	0.50
XC0603A105KQ8*NN-S	1uF		6.3	±10%	0.90
XC0603A105KQ5*NL-S	1uF		6.3	±10%	0.50

❖ Product Lineup (Standard & High Capacitors-X5R)

Part Number	Size LxW (mm)	Capacitance	Rated Voltage (Vdc)	Capacitance Tolerance	Thickness Max. (mm)	
XC0603A105KR8*NN-S	1.60x0.80	1uF	4	±10%	0.90	
XC0603A105KR5*NL-S		1uF	4	±10%	0.50	
XC0603A105KA5*NL-S		1uF	25	±10%	0.50	
XC0603A225KA8*NN-S		2.2uF	25	±10%	0.90	
XC0603A225KA5*NL-S		2.2uF	25	±10%	0.50	
XC0603A225KO8*NN-S		2.2uF	16	±10%	0.90	
XC0603A225KO5*NL-S		2.2uF	16	±10%	0.50	
XC0603A225KP8*NN-S		2.2uF	10	±10%	0.90	
XC0603A225KP5*NL-S		2.2uF	10	±10%	0.50	
XC0603A225KQ8*NN-S		2.2uF	6.3	±10%	0.90	
XC0603A225KQ5*NL-S		2.2uF	6.3	±10%	0.50	
XC0603A225KR8*NN-S		2.2uF	4	±10%	0.90	
XC0603A225KR5*NL-S		2.2uF	4	±10%	0.50	
XC0603A335KQ8*NN-S		3.3uF	6.3	±10%	0.90	
XC0603A335KR8*NN-S		3.3uF	4	±10%	0.90	
XC0603A475KA8*QN-S		4.7uF	25	±10%	0.95	
XC0603A475KO8*NN-S		4.7uF	16	±10%	0.90	
XC0603A475KP8*NN-S		4.7uF	10	±10%	0.90	
XC0603A475KP5*NL-S		4.7uF	10	±10%	0.50	
XC0603A475KQ5*NL-S		4.7uF	6.3	±10%	0.50	
XC0603A475KQ8*NN-S		4.7uF	6.3	±10%	0.90	
XC0603A475KR5*NL-S		4.7uF	4	±10%	0.50	
XC0603A475KR8*NN-S		4.7uF	4	±10%	0.90	
XC0603A106KR8*NN-S		10uF	4	±10%	0.90	
XC0603A106MR5*RL-S		10uF	4	±20%	0.50	
XC0603A106KQ8*NN-S		10uF	6.3	±10%	0.90	
XC0603A106MQ5*RL-S		10uF	6.3	±20%	0.50	
XC0603A106MP8*NN-S		10uF	10	±20%	0.90	
XC0603A106MO8*QN-S		10uF	16	±20%	0.95	
XC0603A106MA8*RN-S		10uF	25	±20%	1.00	
XC0603A226MR8*RN-S		22uF	4	±20%	1.00	
XC0603A226MQ8*RN-S		22uF	6.3	±20%	1.00	
XC0603A226MP8*RN-S		22uF	10	±20%	1.00	
XC0603A226MP8*UN-S		22uF	10	±20%	1.05	
XC0603A476MR8*ZN-S		47uF	4	±20%	1.10	
XC0603A476MQ8*ZC-S		47uF	6.3	±20%	1.10	
XC0805A105KBQ*NN-S		2.00x1.25	1uF	50	±10%	1.40
XC0805A105KAF*NN-S			1uF	25	±10%	1.35
XC0805A105KA6*NL-S			1uF	25	±10%	0.70
XC0805A105KOF*NN-S			1uF	16	±10%	1.35
XC0805A105KO6*NL-S	1uF		16	±10%	0.70	
XC0805A105KQF*NN-S	1uF		6.3	±10%	1.35	
XC0805A105KRF*NN-S	1uF		4	±10%	1.35	
XC0805A225KBQ*NN-S	2.2uF		50	±10%	1.40	
XC0805A225KAF*NN-S	2.2uF		25	±10%	1.35	
XC0805A225KO6*NL-S	2.2uF		16	±10%	0.70	
XC0805A225KOF*NN-S	2.2uF		16	±10%	1.35	
XC0805A225KPF*NN-S	2.2uF		10	±10%	1.35	
XC0805A225KQF*NN-S	2.2uF		6.3	±10%	1.35	
XC0805A225KRF*NN-S	2.2uF		4	±10%	1.35	
XC0805A475KBQ*NN-S	4.7uF		50	±10%	1.40	

Note: (*) Represents Packaging Code

❖ Product Lineup (Standard & High Capacitors-X5R)

Part Number	Size LxW (mm)	Capacitance	Rated Voltage (Vdc)	Capacitance Tolerance	Thickness Max. (mm)	
XC0805A475KAQ*NN-S	2.00x1.25	4.7uF	25	±10%	1.40	
XC0805A475KAC*RL-S		4.7uF	25	±10%	0.95	
XC0805A475KOF*NN-S		4.7uF	16	±10%	1.35	
XC0805A475KOC*NL-S		4.7uF	16	±10%	0.95	
XC0805A475KPF*NN-S		4.7uF	10	±10%	1.35	
XC0805A475KPC*NL-S		4.7uF	10	±10%	0.95	
XC0805A475KQF*NN-S		4.7uF	6.3	±10%	1.35	
XC0805A475KQC*NL-S		4.7uF	6.3	±10%	0.95	
XC0805A475KRF*NN-S		4.7uF	4	±10%	1.35	
XC0805A475KRC*NL-S		4.7uF	4	±10%	0.95	
XC0805A106KAY*NN-S		10uF	25	±10%	1.45	
XC0805A106KAC*RL-S		10uF	25	±10%	0.95	
XC0805A106KA7*QL-S		10uF	25	±10%	0.80	
XC0805A106KOF*NN-S		10uF	16	±10%	1.35	
XC0805A106KOQ*NN-S		10uF	16	±10%	1.40	
XC0805A106KOC*RL-S		10uF	16	±10%	0.95	
XC0805A106KOC*3L-S		10uF	16	±10%	0.95	
XC0805A106KPF*NN-S		10uF	10	±10%	1.35	
XC0805A106KPC*QL-S		10uF	10	±10%	0.95	
XC0805A106KQF*NN-S		10uF	6.3	±10%	1.35	
XC0805A106KQC*NL-S		10uF	6.3	±10%	0.95	
XC0805A106KRF*NN-S		10uF	4	±10%	1.35	
XC0805A106KRC*NL-S		10uF	4	±10%	0.95	
XC0805A226MAQ*NN-S		22uF	25	±20%	1.40	
XC0805A226MPQ*NN-S		22uF	10	±20%	1.40	
XC0805A226MPC*RL-S		22uF	10	±20%	0.95	
XC0805A226MQQ*NN-S		22uF	6.3	±20%	1.40	
XC0805A226MQC*RL-S		22uF	6.3	±20%	0.95	
XC0805A226MRQ*NN-S		22uF	4	±20%	1.40	
XC0805A226MRC*RL-S		22uF	4	±20%	0.95	
XC0805A336MQE*NL-S		33uF	6.3	±20%	1.20	
XC0805A336MQ9*NL-S		33uF	6.3	±20%	1.00	
XC0805A336MRE*NL-S		33uF	4	±20%	1.20	
XC0805A336MR9*NL-S		33uF	4	±20%	1.00	
XC0805A476MQY*NN-S		47uF	6.3	±20%	1.45	
XC0805A476MR9*NN-S		47uF	4	±20%	1.45	
XC0805A476MQ9*RL-S		47uF	6.3	±20%	1.00	
XC1206A225KC9*NL-S		3.20x1.60	2.2uF	100	±10%	1.00
XC1206A475KBH*NN-S			4.7uF	50	±10%	1.80
XC1206A475KB9*NL-S			4.7uF	50	±10%	1.00
XC1206A475KAH*NN-S	4.7uF		25	±10%	1.80	
XC1206A475KAC*NL-S	4.7uF		25	±10%	0.95	
XC1206A475KOH*NN-S	4.7uF		16	±10%	1.80	
XC1206A475KOC*NL-S	4.7uF		16	±10%	0.95	
XC1206A475KPH*NN-S	4.7uF		10	±10%	1.80	
XC1206A475KQH*NN-S	4.7uF		6.3	±10%	1.80	
XC1206A475KRH*NN-S	4.7uF		4	±10%	1.80	
XC1206A106KBH*NN-S	10uF		50	±10%	1.80	
XC1206A106KAH*NN-S	10uF		25	±10%	1.80	
XC1206A106KAC*NL-S	10uF		25	±10%	0.95	
XC1206A106KOH*NN-S	10uF		16	±10%	1.80	

Note: (*) Represents Packaging Code

❖ Product Lineup (Standard & High Capacitors-X5R)

Part Number	Size LxW (mm)	Capacitance	Rated Voltage (Vdc)	Capacitance Tolerance	Thickness Max. (mm)	
XC1206A106KOC*NL-S	3.20x1.60	10uF	16	±10%	0.95	
XC1206A106KPH*NN-S		10uF	10	±10%	1.80	
XC1206A106KPC*NL-S		10uF	10	±10%	0.95	
XC1206A106KQH*NN-S		10uF	6.3	±10%	1.80	
XC1206A106KRH*NN-S		10uF	4	±10%	1.80	
XC1206A156KQH*NN-S		15uF	6.3	±10%	1.80	
XC1206A156KRH*NN-S		15uF	4	±10%	1.80	
XC1206A226KAH*NN-S		22uF	25	±10%	1.80	
XC1206A226KOH*NN-S		22uF	16	±10%	1.80	
XC1206A226KOC*NL-S		22uF	16	±10%	0.95	
XC1206A226KPH*NN-S		22uF	10	±10%	1.80	
XC1206A226KPC*NL-S		22uF	10	±10%	0.95	
XC1206A226KQH*NN-S		22uF	6.3	±10%	1.80	
XC1206A476KPH*NN-S		47uF	10	±10%	1.80	
XC1206A476MQH*NN-S		47uF	6.3	±20%	1.80	
XC1206A476MRH*NN-S		47uF	4	±20%	1.80	
XC1206A107MQH*NN-S		100uF	6.3	±20%	1.80	
XC1206A107MRH*NN-S		100uF	4	±20%	1.80	
XC1206A107MPH*NN-S		100uF	10	±20%	1.80	
XC1210A107MQV*NN-S		100uF	6.3	±20%	2.80	
XC1210A106KQC*NL-S		3.20x2.50	10uF	6.3	±10%	0.95
XC1210A106KRC*NL-S			10uF	4	±10%	0.95
XC1210A106KBU*NL-S			10uF	50	±10%	2.00
XC1210A106KAJ*NN-S			10uF	25	±10%	2.70
XC1210A106KAU*NL-S	10uF		25	±10%	2.00	
XC1210A106KOJ*NN-S	10uF		16	±10%	2.70	
XC1210A106KPJ*NN-S	10uF		10	±10%	2.70	
XC1210A226KAJ*NN-S	22uF		25	±10%	2.70	
XC1210A226KOJ*NN-S	22uF		16	±10%	2.70	
XC1210A226KOC*NL-S	22uF		16	±10%	0.95	
XC1210A226KPJ*NN-S	22uF		10	±10%	2.70	
XC1210A226KQJ*NN-S	22uF		6.3	±10%	2.70	
XC1210A226MQC*NL-S	22uF		6.3	±20%	0.95	
XC1210A226KRJ*NN-S	22uF		4	±10%	2.70	
XC1210A226MRC*NL-S	22uF		4	±20%	0.95	
XC1210A476KOJ*NN-S	47uF		16	±10%	2.70	
XC1210A476KPJ*NN-S	47uF		10	±10%	2.70	
XC1210A476MQJ*NN-S	47uF		6.3	±20%	2.70	
XC1210A476MRJ*NN-S	47uF		4	±20%	2.70	
XC1210A107MPV*NN-S	100uF		10	±20%	2.80	
XC1210A107MRV*NN-S	100uF		4	±20%	2.80	
XC1210A157MQV*NN-S	150uF		6.3	±20%	2.80	
XC1210A227MQV*NN-S	220uF		6.3	±20%	2.80	
XC1812A476MQJ*NN-S	4.50x3.20		47uF	6.3	±20%	2.70
XC1812A476MRJ*NN-S			47uF	4	±20%	2.70
XC1812A107KQL*NN-S			100uF	6.3	±10%	3.50
XC1812A107KRL*NN-S			100uF	4	±10%	3.50

Note: (*) Represents Packaging Code

❖ Product Lineup (Standard & High Capacitors-X6S)

Part Number	Size LxW (mm)	Capacitance	Rated Voltage (Vdc)	Capacitance Tolerance	Thickness Max. (mm)	
XC0402X224KP5*NN-S	1.00x0.50	0.22uF	10	±10%	0.55	
XC0402X224KQ5*NN-S		0.22uF	6.3	±10%	0.55	
XC0402X474KP5*NN-S		0.47uF	10	±10%	0.55	
XC0402X474KQ5*NN-S		0.47uF	6.3	±10%	0.55	
XC0402X474MR5*NN-S		0.47uF	4	+20%	0.55	
XC0402X684JQ5*NN-S		0.68uF	6.3	+5%	0.55	
XC0402X105KA5*QN-S		1uF	25	±10%	0.60	
XC0402X105KP5*NN-S		1uF	10	±10%	0.55	
XC0402X105MQ3*NL-S		1uF	6.3	+20%	0.33	
XC0402X225MP5*UN-S		2.2uF	10	+20%	0.70	
XC0402X475MQ5*UN-S		4.7uF	6.3	+20%	0.70	
XC0402X106MR5*UN-S		10uF	4	+20%	0.70	
XC0603X474KA8*NN-S		1.60x0.80	0.47uF	25	±10%	0.90
XC0603X474KO8*NN-S			0.47uF	16	±10%	0.90
XC0603X474KP8*NN-S	0.47uF		10	±10%	0.90	
XC0603X474KQ8*NN-S	0.47uF		6.3	±10%	0.90	
XC0603X474KR8*NN-S	0.47uF		4	±10%	0.90	
XC0603X105KA8*NN-S	1uF		25	±10%	0.90	
XC0603X105KO8*NN-S	1uF		16	±10%	0.90	
XC0603X105KP8*NN-S	1uF		10	±10%	0.90	
XC0603X105KQ8*NN-S	1uF		6.3	±10%	0.90	
XC0603X105KR8*NN-S	1uF		4	±10%	0.90	
XC0603X225KO8*NN-S	2.2uF		16	±10%	0.90	
XC0603X225KP8*NN-S	2.2uF		10	±10%	0.90	
XC0603X225KQ8*NN-S	2.2uF		6.3	±10%	0.90	
XC0603X225KR8*NN-S	2.2uF		4	±10%	0.90	
XC0603X475KA8*QN-S	4.7uF		25	±10%	0.95	
XC0603X475KO8*QN-S	4.7uF		16	±10%	0.95	
XC0603X475KP5*NN-S	4.7uF		10	±10%	0.90	
XC0603X475KQ8*NN-S	4.7uF		6.3	±10%	0.90	
XC0603X475KR8*NN-S	4.7uF		4	±10%	0.90	
XC0603X106MP8*NN-S	10uF		10	+20%	0.90	
XC0603X106KQ8*NN-S	10uF		6.3	±10%	0.90	
XC0603X106KR8*NN-S	10uF		4	±10%	0.90	
XC0805X105KAF*NN-S	2.00x1.25		1uF	25	±10%	1.35
XC0805X105KOF*NN-S			1uF	16	±10%	1.35
XC0805X105KPF*NN-S			1uF	10	±10%	1.35
XC0805X105KQF*NN-S			1uF	6.3	±10%	1.35
XC0805X105KRF*NN-S			1uF	4	±10%	1.35
XC0805X225KAF*NN-S			2.2uF	25	±10%	1.35
XC0805X225KOF*NN-S			2.2uF	16	±10%	1.35
XC0805X225KPF*NN-S			2.2uF	10	±10%	1.35
XC0805X225KQF*NN-S			2.2uF	6.3	±10%	1.35
XC0805X225KRF*NN-S			2.2uF	4	±10%	1.35
XC0805X475KAQ*NN-S			4.7uF	25	±10%	1.40
XC0805X475KOF*NN-S			4.7uF	16	±10%	1.35
XC0805X475KPF*NN-S		4.7uF	10	±10%	1.35	
XC0805X475KQF*NN-S		4.7uF	6.3	±10%	1.35	

Note: (*) Represents Packaging Code

❖ Product Lineup (Standard & High Capacitors-X6S)

Part Number	Size LxW (mm)	Capacitance	Rated Voltage (Vdc)	Capacitance Tolerance	Thickness Max. (mm)	
XC0805X475KRF*NN-S	2.00x1.25	4.7uF	4	±10%	1.35	
XC0805X106KAC*RL-S		10uF	25	±10%	0.95	
XC0805X106KAY*NN-S		10uF	25	±10%	1.45	
XC0805X106KOY*NN-S		10uF	16	±10%	1.45	
XC0805X106KPC*NL-S		10uF	10	±10%	0.95	
XC0805X106KPY*NN-S		10uF	10	±10%	1.45	
XC0805X106KQQ*NN-S		10uF	6.3	±10%	1.40	
XC0805X106KRQ*NN-S		10uF	4	±10%	1.40	
XC0805X106KRC*NL-S		10uF	4	±10%	0.95	
XC0805X226MQQ*NN-S		22uF	6.3	±20%	1.40	
XC0805X226MRQ*NN-S		22uF	4	±20%	1.40	
XC0805X476MRY*NN-S		47uF	4	±20%	1.45	
XC1206X475KAH*NN-S		3.20x1.60	4.7uF	25	±10%	1.80
XC1206X475KAC*NL-S			4.7uF	25	±10%	0.95
XC1206X475KOH*NN-S	4.7uF		16	±10%	1.80	
XC1206X475KPH*NN-S	4.7uF		10	±10%	1.80	
XC1206X475MQH*NN-S	4.7uF		6.3	±20%	1.80	
XC1206X475KRH*NN-S	4.7uF		4	±10%	1.80	
XC1206X106KAC*NL-S	10uF		25	±10%	0.95	
XC1206X106KAH*NN-S	10uF		25	±10%	1.80	
XC1206X106KOH*NN-S	10uF		16	±10%	1.80	
XC1206X106KPH*NN-S	10uF		10	±10%	1.80	
XC1206X106QH*NN-S	10uF		6.3	±10%	1.80	
XC1206X106KRH*NN-S	10uF		4	±10%	1.80	
XC1206X226KOH*NN-S	22uF		16	±10%	1.80	
XC1206X226KPH*NN-S	22uF		10	±10%	1.80	
XC1206X226QH*NN-S	22uF		6.3	±10%	1.80	
XC1206X226KRH*NN-S	22uF		4	±10%	1.80	
XC1206X107MQH*NN-S	100uF		6.3	±20%	1.80	
XC1206X107MRH*NN-S	100uF		4	±20%	1.80	
XC1210X106KAU*NN-S	3.20x2.50		10uF	25	±10%	2.00
XC1210X106KOJ*NN-S			10uF	16	±10%	2.70
XC1210X106KPJ*NN-S			10uF	10	±10%	2.70
XC1210X106KQJ*NN-S			10uF	6.3	±10%	2.70
XC1210X106KRJ*NN-S			10uF	4	±10%	2.70
XC1210X226KAJ*NN-S			22uF	25	±10%	2.70
XC1210X226KOJ*NN-S			22uF	16	±10%	2.70
XC1210X226KPJ*NN-S			22uF	10	±10%	2.70
XC1210X226KQJ*NN-S			22uF	6.3	±10%	2.70
XC1210X226KRJ*NN-S			22uF	4	±10%	2.70
XC1210X476MPJ*NN-S		47uF	10	±20%	2.70	
XC1210X476KQJ*NN-S		47uF	6.3	±10%	2.70	
XC1210X476KRJ*NN-S		47uF	4	±10%	2.70	
XC1210X107MQV*NN-S		100uF	6.3	±20%	2.80	
XC1210X107MRV*NN-S		100uF	4	±20%	2.80	

Note: (*) Represents Packaging Code

❖ Product Lineup (Standard & High Capacitors-X7R, X7S)

Part Number	Size LxW (mm)	Capacitance	Rated Voltage (Vdc)	Capacitance Tolerance	Thickness Max. (mm)	
XC0402B151KB5*NN-S	1.00x0.50	150pF	50	±10%	0.55	
XC0402B181KB5*NN-S		180pF	50	±10%	0.55	
XC0402B221KB5*NN-S		220pF	50	±10%	0.55	
XC0402B271KB5*NN-S		270pF	50	±10%	0.55	
XC0402B331KB5*NN-S		330pF	50	±10%	0.55	
XC0402B391KB5*NN-S		390nF	50	±10%	0.55	
XC0402B471KB5*NN-S		470pF	50	±10%	0.55	
XC0402B561KB5*NN-S		560pF	50	±10%	0.55	
XC0402B681KB5*NN-S		680pF	50	±10%	0.55	
XC0402B102KB5*NN-S		1nF	50	±10%	0.55	
XC0402B122KB5*NN-S		1.2nF	50	±10%	0.55	
XC0402B152KB5*NN-S		1.5nF	50	±10%	0.55	
XC0402B182KB5*NN-S		1.8nF	50	±10%	0.55	
XC0402B222KB5*NN-S		2.2nF	50	±10%	0.55	
XC0402B272KB5*NN-S		2.7nF	50	±10%	0.55	
XC0402B332KB5*NN-S		3.3nF	50	±10%	0.55	
XC0402B472KB5*NN-S		4.7nF	50	±10%	0.55	
XC0402B562KB5*NN-S		5.6nF	50	±10%	0.55	
XC0402B682KB5*NN-S		6.8nF	50	±10%	0.55	
XC0402B822KB5*NN-S		8.2nF	50	±10%	0.55	
XC0402B103KB5*NN-S		10nF	50	±10%	0.55	
XC0402B123KA5*NN-S		12nF	25	±10%	0.55	
XC0402B153KA5*NN-S		15nF	25	±10%	0.55	
XC0402B223KA5*NN-S		22nF	25	±10%	0.55	
XC0402B273KO5*NN-S		27nF	16	±10%	0.55	
XC0402B333KO5*NN-S		33nF	16	±10%	0.55	
XC0402B393KO5*NN-S		39nF	16	±10%	0.55	
XC0402B473KO5*NN-S		47nF	16	±10%	0.55	
XC0402B563KO5*NN-S		56nF	16	±10%	0.55	
XC0402B683KO5*NN-S		68nF	16	±10%	0.55	
XC0402B823KO5*NN-S		82nF	16	±10%	0.55	
XC0402B104KO5*NN-S		100nF	16	±10%	0.55	
XC0402B224KO5*NN-S		220nF	16	±10%	0.55	
XC0402B474KP5*NN-S		470nF	10	±10%	0.55	
XC0402B105KQ5*QN-S		1uF	6.3	±10%	0.60	
XC0402Y474KP5*NN-S		470nF	10	±10%	0.55	
XC0603B101KB8*NN-S		1.60x0.80	100pF	50	±10%	0.90
XC0603B121KB8*NN-S			120pF	50	±10%	0.90
XC0603B151KB8*NN-S			150pF	50	±10%	0.90
XC0603B181KB8*NN-S			180pF	50	±10%	0.90
XC0603B201KB8*NN-S	200pF		50	±10%	0.90	
XC0603B221KB8*NN-S	220pF		50	±10%	0.90	
XC0603B271KB8*NN-S	270pF		50	±10%	0.90	
XC0603B331KB8*NN-S	330pF		50	±10%	0.90	
XC0603B391KB8*NN-S	390pF		50	±10%	0.90	
XC0603B471KB8*NN-S	470pF		50	±10%	0.90	
XC0603B561KB8*NN-S	560pF		50	±10%	0.90	
XC0603B681KB8*NN-S	680pF		50	±10%	0.90	
XC0603B751KB8*NN-S	750pF		50	±10%	0.90	
XC0603B821KB8*NN-S	820pF		50	±10%	0.90	
XC0603B102KB8*NN-S	1nF		50	±10%	0.90	
XC0603B122KB8*NN-S	1.2nF		50	±10%	0.90	

Note: (*) Represents Packaging Code

❖ Product Lineup (Standard & High Capacitors-X7R)

Part Number	Size LxW (mm)	Capacitance	Rated Voltage (Vdc)	Capacitance Tolerance	Thickness Max. (mm)	
XC0603B152KB8*NN-S	1.60x0.80	1.5nF	50	±10%	0.90	
XC0603B182KB8*NN-S		1.8nF	50	±10%	0.90	
XC0603B202KB8*NN-S		2nF	50	±10%	0.90	
XC0603B222KB8*NN-S		2.2nF	50	±10%	0.90	
XC0603B332KB8*NN-S		3.3nF	50	±10%	0.90	
XC0603B392KB8*NN-S		3.9nF	50	±10%	0.90	
XC0603B472KB8*NN-S		4.7nF	50	±10%	0.90	
XC0603B562KB8*NN-S		5.6nF	50	±10%	0.90	
XC0603B682KB8*NN-S		6.8nF	50	±10%	0.90	
XC0603B822KB8*NN-S		8.2nF	50	±10%	0.90	
XC0603B103JB8*NN-S		10nF	50	±5%	0.90	
XC0603B123KB8*NN-S		12nF	50	±10%	0.90	
XC0603B153KB8*NN-S		15nF	50	±10%	0.90	
XC0603B183KB8*NN-S		18nF	50	±10%	0.90	
XC0603B223KB8*NN-S		22nF	50	±10%	0.90	
XC0603B273KB8*NN-S		27nF	50	±10%	0.90	
XC0603B333JB8*NN-S		33nF	50	±5%	0.90	
XC0603B393KB8*NN-S		39nF	50	±10%	0.90	
XC0603B473KB8*NN-S		47nF	50	±10%	0.90	
XC0603B563KB8*NN-S		56nF	50	±10%	0.90	
XC0603B683KB8*NN-S		68nF	50	±10%	0.90	
XC0603B823KB8*NN-S		82nF	50	±10%	0.90	
XC0603B104KB8*NN-S		100nF	50	±10%	0.90	
XC0603B124KO8*NN-S		120nF	16	±10%	0.90	
XC0603B154KA8*NN-S		150nF	25	±10%	0.90	
XC0603B224KA8*NN-S		220nF	25	±10%	0.90	
XC0603B474KA8*NN-S		470nF	25	±10%	0.90	
XC0603B684KO8*NN-S		680nF	16	±10%	0.90	
XC0603B105KA8*NN-S		1µF	25	±10%	0.90	
XC0603B225KP8*NN-S		2.2µF	10	±10%	0.90	
XC0805B151KBA*NN-S		2.00x1.25	150pF	50	±10%	0.75
XC0805B181KBA*NN-S			180pF	50	±10%	0.75
XC0805B221KBA*NN-S			220pF	50	±10%	0.75
XC0805B331KBA*NN-S	330pF		50	±10%	0.75	
XC0805B391KBA*NN-S	390pF		50	±10%	0.75	
XC0805B471KBA*NN-S	470pF		50	±10%	0.75	
XC0805B511KBA*NN-S	510pF		50	±10%	0.75	
XC0805B561KBA*NN-S	560pF		50	±10%	0.75	
XC0805B681KBA*NN-S	680pF		50	±10%	0.75	
XC0805B821KBA*NN-S	820pF		50	±10%	0.75	
XC0805B102KBA*NN-S	1nF		50	±10%	0.75	
XC0805B122KBA*NN-S	1.2nF		50	±10%	0.75	
XC0805B152KBA*NN-S	1.5nF		50	±10%	0.75	
XC0805B182KBA*NN-S	1.8nF		50	±10%	0.75	
XC0805B202KBA*NN-S	2nF		50	±10%	0.75	
XC0805B222KBA*NN-S	2.2nF		50	±10%	0.75	
XC0805B272KBA*NN-S	2.7nF		50	±10%	0.75	
XC0805B332KBA*NN-S	3.3nF		50	±10%	0.75	
XC0805B472KBA*NN-S	4.7nF		50	±10%	0.75	
XC0805B562KBA*NN-S	5.6nF		50	±10%	0.75	
XC0805B682KBA*NN-S	6.8nF		50	±10%	0.75	

Note: (*) Represents Packaging Code

❖ Product Lineup (Standard & High Capacitors-X7R)

Part Number	Size LxW (mm)	Capacitance	Rated Voltage (Vdc)	Capacitance Tolerance	Thickness Max. (mm)	
XC0805B103KBA*NN-S	2.00x1.25	10nF	50	±10%	0.75	
XC0805B123KBA*NN-S		12nF	50	±10%	0.75	
XC0805B153KBA*NN-S		15nF	50	±10%	0.75	
XC0805B333KBA*NN-S		33nF	50	±10%	0.75	
XC0805B393KBA*NN-S		39nF	50	±10%	0.75	
XC0805B473KBA*NN-S		47nF	50	±10%	0.75	
XC0805B563KBC*NN-S		56nF	50	±10%	0.95	
XC0805B683KAA*NN-S		68nF	25	±10%	0.75	
XC0805B683JBC*NN-S		68nF	50	±5%	0.95	
XC0805B683KBF*NN-S		68nF	50	±10%	1.35	
XC0805B823KBC*NN-S		82nF	50	±10%	0.95	
XC0805B823KBF*NN-S		82nF	50	±10%	1.35	
XC0805B104KAC*NN-S		100nF	25	±10%	0.95	
XC0805B104KBC*NN-S		100nF	50	±10%	0.95	
XC0805B104KBF*NN-S		100nF	50	±10%	1.35	
XC0805B124KBF*NN-S		120nF	50	±10%	1.35	
XC0805B124KAC*NN-S		120nF	25	±10%	0.95	
XC0805B154KOA*NN-S		150nF	16	±10%	0.75	
XC0805B154KBF*NN-S		150nF	50	±10%	1.35	
XC0805B224KBF*NN-S		220nF	50	±10%	1.35	
XC0805B334KAF*NN-S		330nF	25	±10%	1.35	
XC0805B474KAF*NN-S		470nF	25	±10%	1.35	
XC0805B684KOF*NN-S		680nF	16	±10%	1.35	
XC0805B105KBF*NN-S		1µF	50	±10%	1.35	
XC0805B155KAF*NN-S		1.5µF	25	±10%	1.35	
XC0805B225KAF*NN-S		2.2µF	25	±10%	1.35	
XC0805B475KQQ*NN-S		4.7µF	6.3	±10%	1.40	
XC0805B475KAF*NN-S		4.7µF	25	±10%	1.35	
XC0805B106KOO*NN-S		10µF	16	±10%	1.40	
XC1206B221KBC*NN-S		3.20x1.60	220pF	50	±10%	1.00
XC1206B331KBC*NN-S			330pF	50	±10%	1.00
XC1206B471KBC*NN-S			470pF	50	±10%	1.00
XC1206B561KBC*NN-S			560pF	50	±10%	1.00
XC1206B152KBC*NN-S	1.5nF		50	±10%	1.00	
XC1206B222KBC*NN-S	2.2nF		50	±10%	1.00	
XC1206B332KBC*NN-S	3.3nF		50	±10%	1.00	
XC1206B472KBC*NN-S	4.7nF		50	±10%	1.00	
XC1206B473KBC*NN-S	47nF		50	±10%	1.00	
XC1206B562KBC*NN-S	5.6nF		50	±10%	1.00	
XC1206B682KBC*NN-S	6.8nF		50	±10%	1.00	
XC1206B822KBC*NN-S	8.2nF		50	±10%	1.00	
XC1206B103KBC*NN-S	10nF		50	±10%	1.00	
XC1206B123KBC*NN-S	12nF		50	±10%	1.00	
XC1206B153KBC*NN-S	15nF		50	±10%	1.00	
XC1206B223KBC*NN-S	22nF		50	±10%	1.00	
XC1206B333KBC*NN-S	33nF		50	±10%	1.00	
XC1206B683KBC*NN-S	68nF		50	±10%	1.00	
XC1206B104KBC*NN-S	100nF		50	±10%	1.00	
XC1206B154KBC*NN-S	150nF		50	±10%	1.00	
XC1206B224KBF*NN-S	220nF		50	±10%	1.40	
XC1206B334KBF*NN-S	330nF		50	±10%	1.40	

Note: (*) Represents Packaging Code

❖ Product Lineup (Standard & High Capacitors-X7R)

Part Number	Size LxW (mm)	Capacitance	Rated Voltage (Vdc)	Capacitance Tolerance	Thickness Max. (mm)	
XC1206B334KAC*NN-S	3.20x1.60	330nF	25	±10%	1.00	
XC1206B474KBH*NN-S		470nF	50	±10%	1.80	
XC1206B474MAF*NN-S		470nF	25	±20%	1.40	
XC1206B684KOC*NN-S		680nF	16	±10%	1.00	
XC1206B684KBH*NN-S		680nF	50	±10%	1.80	
XC1206B105KBH*NN-S		1uF	50	±10%	1.80	
XC1206B225KAH*NN-S		2.2uF	25	±10%	1.80	
XC1206B335KAH*NN-S		3.3uF	25	±10%	1.80	
XC1206B475KBH*NN-S		4.7uF	50	±10%	1.80	
XC1206B106KBH*NN-S		10uF	50	±10%	1.80	
XC1206B226KPH*NN-S		22uF	10	±10%	1.80	
XC1210B104KBF*NN-S		3.20x2.50	100nF	50	±10%	1.45
XC1210B154KBF*NN-S			150nF	50	±10%	1.45
XC1210B224KBF*NN-S	220nF		50	±10%	1.45	
XC1210B334KBF*NN-S	330nF		50	±10%	1.45	
XC1210B474KBF*NN-S	470nF		50	±10%	1.45	
XC1210B105KBH*NN-S	1uF		50	±10%	1.80	
XC1210B225KBJ*NN-S	2.2uF		50	±10%	2.70	
XC1210B225KAI*NN-S	2.2uF		25	±10%	2.20	
XC1210B475KBJ*NN-S	4.7uF		50	±10%	2.70	
XC1210B475KBU*NY-S	4.7uF		50	±10%	2.00	
XC1210B475KOI*NN-S	4.7uF		16	±10%	2.20	
XC1210B106KLJ*NN-S	10uF		35	±10%	2.70	
XC1210B106KAU*NL-S	10uF		25	±10%	2.00	
XC1210B106KPI*NN-S	10uF		10	±10%	2.20	
XC1210B226KAJ*NN-S	22uF		25	±10%	2.70	
XC1210B476MQJ*NN-S	47uF		6.3	±20%	2.70	

Note: (*) Represents Packaging Code

❖ Product Lineup (Standard & High Capacitors-Y5V)

Part Number	Size LxW (mm)	Capacitance	Rated Voltage (Vdc)	Capacitance Tolerance	Thickness Max. (mm)	
XC0402F224ZO5*NN-S	1.00x0.50	0.22uF	16	+80/-20%	0.55	
XC0402F224ZP5*NN-S		0.22uF	10	+80/-20%	0.55	
XC0402F224ZQ5*NN-S		0.22uF	6.3	+80/-20%	0.55	
XC0402F474ZP5*NN-S		0.47uF	10	+80/-20%	0.55	
XC0402F474ZQ5*NN-S		0.47uF	6.3	+80/-20%	0.55	
XC0402F105ZQ5*NN-S		1uF	6.3	+80/-20%	0.55	
XC0603F474ZB8*NN-S	1.60x0.80	0.47uF	50	+80/-20%	0.90	
XC0603F474ZA8*NN-S		0.47uF	25	+80/-20%	0.90	
XC0603F474ZO8*NN-S		0.47uF	16	+80/-20%	0.90	
XC0603F474ZP8*NN-S		0.47uF	10	+80/-20%	0.90	
XC0603F105ZO8*NN-S		1uF	16	+80/-20%	0.90	
XC0603F105ZP8*NN-S		1uF	10	+80/-20%	0.90	
XC0603F225ZP8*NN-S		2.2uF	10	+80/-20%	0.90	
XC0603F225ZQ8*NN-S		2.2uF	6.3	+80/-20%	0.90	
XC0603F475ZQ8*NN-S		4.7uF	6.3	+80/-20%	0.90	
XC0805F105ZBF*NN-S		2.00x1.25	1uF	50	+80/-20%	1.35
XC0805F105ZAF*NN-S	1uF		25	+80/-20%	1.35	
XC0805F105ZOF*NN-S	1uF		16	+80/-20%	1.35	
XC0805F225ZAF*NN-S	2.2uF		25	+80/-20%	1.35	
XC0805F225ZOF*NN-S	2.2uF		16	+80/-20%	1.35	
XC0805F475ZQF*NN-S	4.7uF		6.3	+80/-20%	1.35	
XC0805F475ZOF*NN-S	4.7uF		16	+80/-20%	1.35	
XC0805F475ZPF*NN-S	4.7uF		10	+80/-20%	1.35	
XC0805F106ZPF*NN-S	10uF		10	+80/-20%	1.35	
XC0805F106ZPC*NL-S	10uF		10	+80/-20%	0.95	
XC0805F106ZQF*NN-S	10uF		6.3	+80/-20%	1.35	
XC0805F106ZQC*NL-S	10uF		6.3	+80/-20%	0.95	
XC1206F475ZOF*NN-S	3.20x1.60		4.7uF	16	+80/-20%	1.40
XC1206F475ZPF*NN-S			4.7uF	10	+80/-20%	1.40
XC1206F475ZQF*NN-S			4.7uF	6.3	+80/-20%	1.40
XC1206F106ZOH*NN-S			10uF	16	+80/-20%	1.80
XC1206F106ZPH*NN-S		10uF	10	+80/-20%	1.80	
XC1206F106ZQH*NN-S		10uF	6.3	+80/-20%	1.80	
XC1206F226ZPH*NN-S		22uF	10	+80/-20%	1.80	
XC1206F226ZQH*NN-S		22uF	6.3	+80/-20%	1.80	
XC1210F106ZAH*NN-S		3.20x2.50	10uF	25	+80/-20%	1.80
XC1210F106ZOE*NL-S			10uF	16	+80/-20%	1.20
XC1210F226ZPJ*NN-S	22uF		10	+80/-20%	2.70	
XC1210F226ZPJ*NL-S	22uF		10	+80/-20%	2.70	
XC1210F476ZQI*NN-S	47uF		6.3	+80/-20%	2.20	
XC1210F107ZQJ*NN-S	100uF		6.3	+80/-20%	2.70	

Note: (*) Represents Packaging Code

MultiLayer Ceramic Capacitors

Super Small Size Capacitors

❖ Features

- Wide Small chip size.
- 01005 and 0201 Series (High Q) MLCC shows very low ESR value.
- 01005 and 0201 Series are suited to only reflow soldering
- 01005 and 0201 Series are suited to miniature RF module, Portable equipment and high frequency circuit.
- RoHS Compliant.

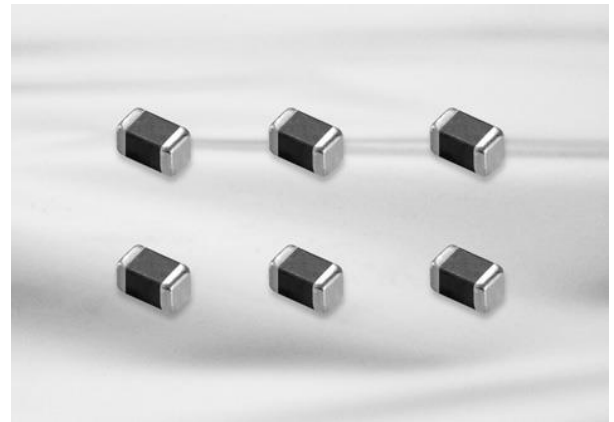

❖ Application

- VCO, Tuner, RF Module
- MCM Module
- Mobile phone, Wireless LAN, Note PC.

❖ Structure and Dimensions

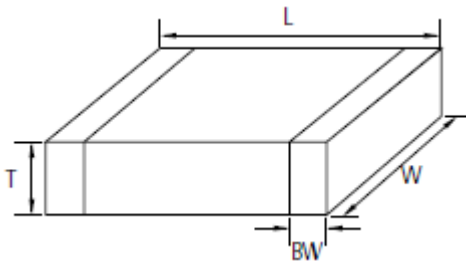

EIA Code (Inch)	Dimension(mm)			
	L	W	T	BW
01005	0.4±0.02	0.2±0.02	0.2±0.02	0.10±0.03
0201	0.6±0.03	0.3±0.03	0.3±0.03	0.15±0.05

❖ Super Small Size Capacitance Table (C0G)

TC	Size Inch (mm)	Vr (V)	Capacitance(µF)							
			0.5	1	10	22	47	100	220	330
C0G	01005(0402)	6.3								
		16								
	0201(0603)	25								
		50								

❖ Super Small Size Capacitance Table (High-Q)

TC	Size Inch (mm)	Vr (V)	Capacitance(µF)							
			0.2	1	10	15	27	33	47	100
C0G	01005(0402)	25								
		25								
	0201(0603)	50								

❖ Super Small Size Capacitance Table (X7R,X6S)

TC	Size Inch (mm)	Vr (V)	Capacitance(nF)							
			0.1	0.22	0.47	1	2.2	3.3	4.7	10
X7R	01005(0402)	10								
		10								
	0201(0603)	16								
		25								
		50								
X6S	0201(0603)	4								

❖ Super Small Size Capacitance Table (X5R, Y5V)

TC	Size Inch (mm)	Vr (V)	Capacitance(µF)							
			0.01	0.1	0.22	0.47	1	2.2	4.7	10
X5R	01005(0402)	6.3								
		10								
		16								
	0201(0603)	4		X5R or X6S						
		6.3								
		10								
		16								
		25								
Y5V	0201(0603)	6.3								

❖ Product Lineup (Super Small Size Capacitors C0G)

Part Number	Size LxW (mm)	Capacitance	Rated Voltage (Vdc)	Capacitance Tolerance	Thickness Max. (mm)	
XC01005C0R5CO2*NA-S	0.40x0.20	0.5pF	16	+0.25pF	0.22	
XC01005C010CO2*NA-S		1.0pF	16	+0.25pF	0.22	
XC01005C1R2CO2*NA-S		1.2pF	16	+0.25pF	0.22	
XC01005C1R5CO2*NA-S		1.5pF	16	+0.25pF	0.22	
XC01005C1R8CO2*NA-S		1.8pF	16	+0.25pF	0.22	
XC01005C020CO2*NA-S		2.0pF	16	+0.25pF	0.22	
XC01005C2R2CO2*NA-S		2.2pF	16	+0.25pF	0.22	
XC01005C2R7CO2*NA-S		2.7pF	16	+0.25pF	0.22	
XC01005C030CO2*NA-S		3.0pF	16	+0.25pF	0.22	
XC01005C3R3CO2*NA-S		3.3pF	16	+0.25pF	0.22	
XC01005C3R9CO2*NA-S		3.9pF	16	+0.25pF	0.22	
XC01005C4R7CO2*NA-S		4.7pF	16	+0.25pF	0.22	
XC01005C5R6DO2*NA-S		5.6pF	16	+0.5pF	0.22	
XC01005C6R8DO2*NA-S		6.8pF	16	+0.5pF	0.22	
XC01005C8R2DO2*NA-S		8.2pF	16	+0.5pF	0.22	
XC01005C090DO2*NA-S		9.0pF	16	+0.5pF	0.22	
XC01005C100JO2*NA-S		10pF	16	+5%	0.22	
XC01005C150JO2*NA-S		15pF	16	+5%	0.22	
XC01005C180JO2*NA-S		18pF	16	+5%	0.22	
XC01005C220JO2*NA-S		22pF	16	+5%	0.22	
XC01005C270JO2*NA-S		27pF	16	+5%	0.22	
XC01005C330JO2*NA-S		33pF	16	+5%	0.22	
XC01005C390JO2*NA-S		39pF	16	+5%	0.22	
XC01005C470JO2*NA-S		47pF	16	+5%	0.22	
XC01005C560JQ2*NA-S		56pF	6.3	+5%	0.22	
XC01005C680JQ2*NA-S		68pF	6.3	+5%	0.22	
XC01005C820JQ2*NA-S		82pF	6.3	+5%	0.22	
XC01005C101JO2*NA-S		100pF	16	+5%	0.22	
XC01005C101JQ2*NA-S		100pF	6.3	+5%	0.22	
XC0201C0R5CA3*NG-S		0.60x0.30	0.5pF	25	+0.25pF	0.33
XC0201C010CA3*NG-S			1.0pF	25	+0.25pF	0.33
XC0201C1R2CA3*NG-S			1.2pF	25	+0.25pF	0.33
XC0201C1R5CA3*NG-S			1.5pF	25	+0.25pF	0.33
XC0201C1R8CA3*NG-S	1.8pF		25	+0.25pF	0.33	
XC0201C020CA3*NG-S	2.0pF		25	+0.25pF	0.33	
XC0201C2R2CA3*NG-S	2.2pF		25	+0.25pF	0.33	
XC0201C2R7CA3*NG-S	2.7pF		25	+0.25pF	0.33	
XC0201C030CA3*NG-S	3.0pF		25	+0.25pF	0.33	
XC0201C3R3CA3*NG-S	3.3pF		25	+0.25pF	0.33	
XC0201C3R9CA3*NG-S	3.9pF		25	+0.25pF	0.33	
XC0201C4R7CA3*NG-S	4.7pF		25	+0.25pF	0.33	
XC0201C5R6DA3*NG-S	5.6pF		25	+0.5pF	0.33	
XC0201C6R8DA3*NG-S	6.8pF		25	+0.5pF	0.33	
XC0201C8R2DA3*NG-S	8.2pF		25	+0.5pF	0.33	
XC0201C090DA3*NG-S	9.0pF		25	+0.5pF	0.33	
XC0201C100JA3*NG-S	10pF		25	+5%	0.33	
XC0201C150JA3*NA-S	15pF		25	+5%	0.33	
XC0201C180JA3*NA-S	18pF		25	+5%	0.33	
XC0201C220JA3*NA-S	22pF		25	+5%	0.33	
XC0201C270JA3*NA-S	27pF		25	+5%	0.33	
XC0201C330JA3*NA-S	33pF		25	+5%	0.33	
XC0201C390JA3*NA-S	39pF		25	+5%	0.33	
XC0201C470JA3*NA-S	47pF		25	+5%	0.33	
XC0201C101JB3*NA-S	100pF		50	+5%	0.33	
XC0201C101JA3*NA-S	100pF		25	+5%	0.33	

Note: (*) Represents Packaging Code

❖ Product Lineup (Super Small Size Capacitors X7R,X6S)

Part Number	Size LxW (mm)	Capacitance	Rated Voltage (Vdc)	Capacitance Tolerance	Thickness Max. (mm)
XC01005B101KP2*NN-S	0.40x0.20	100pF	10	±10%	0.22
XC01005B151KP2*NN-S		150pF	10	±10%	0.22
XC01005B221KP2*NN-S		220pF	10	±10%	0.22
XC01005B331KP2*NN-S		330pF	10	±10%	0.22
XC01005B471KP2*NN-S		470pF	10	±10%	0.22
XC01005B681KP2*NN-S		680pF	10	±10%	0.22
XC01005B102KP2*NN-S		1nF	10	±10%	0.22
XC0201B331KO3*NN-S		0.60x0.30	330pF	16	±10%
XC0201B102KB3*NN-S	1nF		50	±10%	0.33
XC0201B102KO3*NN-S	1nF		16	±10%	0.33
XC0201B332KO3*NN-S	3.3nF		16	±10%	0.33
XC0201B472KQ3*NN-S	4.7nF		6.3	±10%	0.33
XC0201B103KP3*NN-S	10nF		10	±10%	0.33
XC0201X104KR3*NN-S	100nF		4	±10%	0.33

❖ Product Lineup (Super Small Size Capacitors X5R)

Part Number	Size LxW (mm)	Capacitance	Rated Voltage (Vdc)	Capacitance Tolerance	Thickness Max. (mm)
XC01005A151KQ2*NN-S	0.40x0.20	150pF	6.3	±10%	0.22
XC01005A221KQ2*NN-S		220pF	6.3	±10%	0.22
XC01005A331KQ2*NN-S		330pF	6.3	±10%	0.22
XC01005A471KQ2*NN-S		470pF	6.3	±10%	0.22
XC01005A681KQ2*NN-S		680pF	6.3	±10%	0.22
XC01005A102KQ2*NN-S		1nF	6.3	±10%	0.22
XC01005A152KQ2*NN-S		1.5nF	6.3	±10%	0.22
XC01005A222KQ2*NN-S		2.2nF	6.3	±10%	0.22
XC01005A332KQ2*NN-S		3.2nF	6.3	±10%	0.22
XC01005A472KQ2*NN-S		4.7nF	6.3	±10%	0.22
XC01005A682KQ2*NN-S		6.8nF	6.3	±10%	0.22
XC01005A103KQ2*NN-S		10nF	6.3	±10%	0.22
XC01005A104KQ2*NN-S		100nF	6.3	±10%	0.22
XC01005A224MR2*NN-S		220nF	4	±20%	0.22
XC01005A224MQ2*NN-S		220nF	6.3	±20%	0.22
XC0201A103KP3*NN-S	0.60x0.30	10nF	10	±10%	0.33
XC0201A223KQ3*NN-S		22nF	6.3	±10%	0.33
XC0201A473KQ3*NN-S		47nF	6.3	±10%	0.33
XC0201A104MA3*NN-S		100nF	25	±20%	0.33
XC0201A104KO3*NN-S		100nF	16	±10%	0.33
XC0201A104KP3*NN-S		100nF	10	±10%	0.33
XC0201A104KQ3*NN-S		100nF	6.3	±10%	0.33
XC0201A224KQ3*NN-S		220nF	6.3	±10%	0.33
XC0201A224KP3*NN-S		220nF	10	±10%	0.33
XC0201A105MO3*RN-S		1nF	16	±20%	0.39
XC0201A105MQ3*NC-S		1uF	6.3	±20%	0.35
XC0201A105MP3*NN-S		1uF	10	±20%	0.35
XC0201A225MR3*RC-S		2.2uF	4	±20%	0.39
XC0201A225MQ3*RC-S		2.2uF	6.3	±20%	0.39

Note: (*) Represents Packaging Code

MultiLayer Ceramic Capacitors

High-Q Capacitors

Features

- High Q and low ESR in high frequency range
- Tight tolerance available
- High efficiency and low power consumption in RF circuit
- Can be applied to power amplifier module for base-station and GHz range communications.
- RoHS Compliant.



❖ Application

- Base Station
- Set Top Box
- Wireless Equipment
- GPS, Bluetooth

❖ Structure and Dimensions

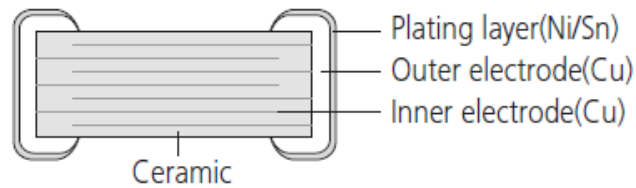
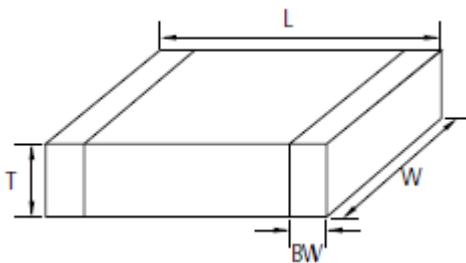

EIA Code (Inch)	Rated Voltage (V)	Dimension(mm)			
		L	W	T	BW
0402	50	1.00+0.05	0.50+0.05	0.50+0.05	0.25+0.10
0603	50/100	1.60+0.10	0.80+0.10	0.80+0.10	0.30+0.20
	250	1.60+0.15	0.80+0.15	0.65+0.10	0.30+0.20
0805	250	2.00+0.15	1.25+0.15	0.85+0.15	0.50+0.20/-0.30

❖ Capacitance Table (High-Q capacitor)

TC	Size Inch (mm)	Vr (V)	Capacitance(pF)											
			0.2	0.5	1	10	15	27	33	47	68	100	150	220
COG	0402(1005)	50												
	0603(1608)	50												
		100												
		250												
	0805(2012)	250												

MultiLayer Ceramic Capacitors

Medium High Voltage Capacitors

❖ Features

- Highly reliable performance.
- Operating at high voltage level.
- Wide voltage level: from 100V to 3000V.
- High withstanding voltage.
- Tape & reel surface mount assembly.
- RoHS compliant.

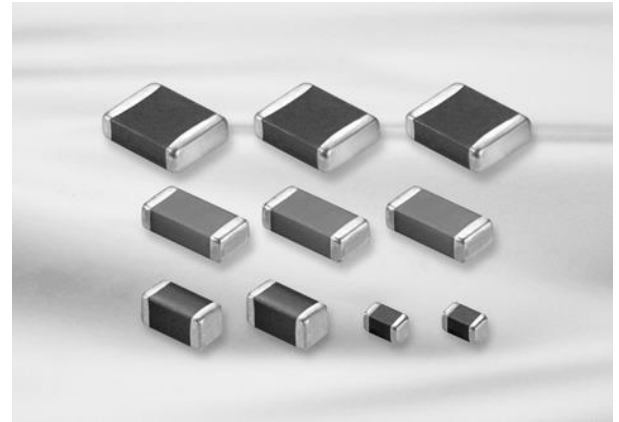

❖ Application

- Switching Power Circuit (SMPS).
- Lighting Ballast, LCD back lighting inverter.
- DC-DC converter input filter, snubber circuit.
- Phone, Fax, Modem.
- Network (IEEE802.3).

❖ Structure and Dimensions

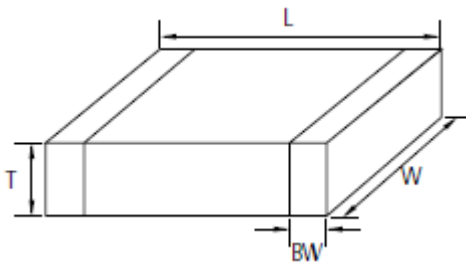

EIA Code (Inch)	Dimension(mm)				
	L	W	T	Thickness Code	BW
0603	1.60±0.10	0.80±0.10	0.80±0.10	8	0.30±0.20
0805	2.00±0.10	1.25±0.10	1.25±0.10	F	0.5+0.2/-0.3
	2.00±0.10	1.25±0.10	0.85±0.10	C	
	2.00±0.10	1.25±0.10	0.65±0.10	A	
1206	3.20±0.20	1.60±0.20	1.60±0.20	H	0.50±0.30
	3.20±0.15	1.60±0.15	1.25±0.15	F	
	3.20±0.15	1.60±0.15	0.85±0.15	C	
1210	3.20±0.30	2.50±0.20	2.50±0.20	J	0.60±0.30
	3.20±0.30	2.50±0.20	1.60±0.20	H	
	3.20±0.30	2.50±0.20	1.25±0.20	F	
1808	4.50±0.40	2.00±0.20	2.00±0.20	I	0.80±0.30
	4.50±0.40	2.00±0.20	1.60±0.20	H	
	4.50±0.40	2.00±0.20	1.25±0.20	F	
1812	4.50±0.40	3.20±0.30	2.50±0.20	J	0.80±0.30
	4.50±0.40	3.20±0.30	1.60±0.20	H	
	4.50±0.40	3.20±0.30	1.25±0.20	F	
2220	5.70±0.40	5.00±0.40	2.50±0.20	J	1.00±0.30
	5.70±0.40	5.00±0.40	1.60±0.20	H	

❖ Medium High Voltage Capacitors Table (C0G)

Vr (V)	Size Inch (mm)	Capacitance																											
		pF						nF																					
		330	390	470	560	680	820	1	1.2	1.5	1.8	2.8	2.7	3.3	3.9	4.7	5.6	6.8	8.2	10	12	15	18	22	27	33	47	56	68
100V	0603(1608)																												
	0805(2012)																												
	1206(3216)																												
	1210(3225)																												
	1812(4532)																												
	2220(5750)																												
200V	0603(1608)																												
	0805(2012)																												
	1206(3216)																												
	1210(3225)																												
	1812(4532)																												
	2220(5750)																												
250V	0603(1608)																												
	0805(2012)																												
	1206(3216)																												
	1210(3225)																												
	1812(4532)																												
	2220(5750)																												
500V	1206(3216)																												
	1210(3225)																												
	1812(4532)																												
	2220(5750)																												
630V	0805(2012)																												
	1206(3216)																												
	1210(3225)																												
	1812(4532)																												
2220(5750)																													

❖ Medium High Voltage Capacitors Table (C0G)

Vr (V)	Size Inch (mm)	Capacitance																									
		pF												nF													
		47	56	68	82	100	120	150	180	220	270	330	390	470	560	680	820	1	1.2	1.5	1.8	2.2	2.7	3.3	3.9	4.7	5.6
1kV	1206(3216)																										
	1210(3225)																										
	1812(4532)																										
	2220(5750)																										
2kV	1206(3216)																										
	1210(3225)																										
	1808(4520)																										
	1812(4532)																										
3kV	2220(5750)																										
	1808(4520)																										
	1812(4532)																										
	2220(5750)																										

❖ Medium High Voltage Capacitors Table (X7R)

Vr (V)	Size Inch (mm)	Capacitance(nF)																									
		4.7	10	15	22	33	47	68	100	150	220	330	470	680	1000	1500	2200	4700									
100V	0603(1608)																										
	0805(2012)																										
	1206(3216)																										
	1210(3225)																										
	1812(4532)																										
	2220(5750)																										
200V	0805(2012)																										
	1206(3216)																										
	1210(3225)																										
	1812(4532)																										
	2220(5750)																										
250V	0805(2012)																										
	1206(3216)																										
	1210(3225)																										
	1812(4532)																										
	2220(5750)																										
350V	1206(3216)		(Tmax=1.0)			(Tmax=1.25)			(Tmax=1.8)																		
500V	1206(3216)																										
	1210(3225)																										
	1812(4532)																										
	2220(5750)																										
630V	1206(3216)																										
	1210(3225)																										
	1812(4532)																										
	2220(5750)																										

❖ Medium High Voltage Capacitors Table (X7R)

Vr (V)	Size Inch (mm)	Capacitance(nF)															
		1	1.5	2.2	3.3	4.7	6.8	10	15	22	33	47	68	100	150	220	330
1KV	1206(3216)																
	1210(3225)																
	1812(4532)																
	2220(5750)																
2KV	1206(3216)																
	1210(3225)																
	1808(4520)																
	1812(4532)																
	2220(5750)																
3KV	1808(4520)																

❖ Product Lineup (Medium High Voltage Capacitors C0G)

Part Number	Size LxW (mm)	Capacitance	Rated Voltage (Vdc)	Capacitance Tolerance	Thickness Max. (mm)	
XC0603C100JC8*NN-S	1.60x0.80	10pF	100	±5%	0.90	
XC0603C150JC8*NN-S		15pF	100	±5%	0.90	
XC0603C330JC8*NN-S		33pF	100	±5%	0.90	
XC0603C390JC8*NN-S		39pF	100	±5%	0.90	
XC0603C470JC8*NN-S		47pF	100	±5%	0.90	
XC0603C560JC8*NN-S		56pF	100	±5%	0.90	
XC0603C101JC8*NN-S		100pF	100	±5%	0.90	
XC0603C121JC8*NN-S		120pF	100	±5%	0.90	
XC0603C151JC8*NN-S		150pF	100	±5%	0.90	
XC0603C331JC8*NN-S		330pF	100	±5%	0.90	
XC0603C331JD8*NN-S		330pF	200	±5%	0.90	
XC0603C331JE8*NN-S		330pF	250	±5%	0.90	
XC0603C391JD8*NN-S		390pF	200	±5%	0.90	
XC0603C391JE8*NN-S		390pF	250	±5%	0.90	
XC0603C471JC8*NN-S		470pF	100	±5%	0.90	
XC0603C471JD8*NN-S		470pF	200	±5%	0.90	
XC0603C471JE8*NN-S		470pF	250	±5%	0.90	
XC0603C561JD8*NN-S		560pF	200	±5%	0.90	
XC0603C561JE8*NN-S		560pF	250	±5%	0.90	
XC0603C681JC8*NN-S		680pF	100	±5%	0.90	
XC0603C681JD8*NN-S		680pF	200	±5%	0.90	
XC0603C681JE8*NN-S		680pF	250	±5%	0.90	
XC0603C821JC8*NN-S		820pF	100	±5%	0.90	
XC0603C102JC8*NN-S		1nF	100	±5%	0.90	
XC0603C122JC8*NN-S		1.2nF	100	±5%	0.90	
XC0805C100JCA*NN-S		2.00x1.25	10pF	100	±5%	0.75
XC0805C120JCA*NN-S			12pF	100	±5%	0.75
XC0805C150JCA*NN-S			15pF	100	±5%	0.75
XC0805C150JDC*NN-S			15pF	200	±5%	0.95
XC0805C180JCA*NN-S			18pF	100	±5%	0.75
XC0805C180JDC*NN-S			18pF	200	±5%	0.95
XC0805C220JCA*NN-S			22pF	100	±5%	0.75
XC0805C270JCA*NN-S			27pF	100	±5%	0.75
XC0805C270JHF*NN-S	27pF		630	±5%	1.35	
XC0805C330JCA*NN-S	33pF		100	±5%	0.75	
XC0805C330JDC*NN-S	33pF		200	±5%	0.95	
XC0805C330JHF*NN-S	33pF		630	±5%	1.35	
XC0805C390JDC*NN-S	39pF		200	±5%	0.95	
XC0805C470JCA*NN-S	47pF		100	±5%	0.75	
XC0805C470JDC*NN-S	47pF		200	±5%	0.95	
XC0805C470JHF*NN-S	47pF		630	±5%	1.35	
XC0805C560JCC*NN-S	56pF		100	±5%	0.95	
XC0805C560JDC*NN-S	56pF		200	±5%	0.95	
XC0805C680JCA*NN-S	68pF		100	±5%	0.75	
XC0805C680JDC*NN-S	68pF		200	±5%	0.95	
XC0805C680JHF*NN-S	68pF		630	±5%	1.35	
XC0805C820JCC*NN-S	82pF		100	±5%	0.95	
XC0805C101JCA*NN-S	100pF		100	±5%	0.75	
XC0805C101JDC*NN-S	100pF		200	±5%	0.95	
XC0805C101JEC*NN-S	100pF		250	±5%	0.95	
XC0805C121JDC*NN-S	120pF		200	±5%	0.95	
XC0805C151JCA*NN-S	150pF		100	±5%	0.75	
XC0805C151JHF*NN-S	150pF		630	±5%	1.35	
XC0805C221JCA*NN-S	220pF		100	±5%	0.75	
XC0805C221JDC*NN-S	220pF		200	±5%	0.95	

Note: (*) Represents Packaging Code

Part Number	Size LxW (mm)	Capacitance	Rated Voltage (Vdc)	Capacitance Tolerance	Thickness Max. (mm)
XC0805C331JCA*NN-S	2.00x1.25	330pF	100	±5%	0.75
XC0805C471JCC*NN-S		470pF	100	±5%	0.95
XC0805C561JCC*NN-S		560pF	100	±5%	0.95
XC0805C561JHF*NN-S		560pF	630	±5%	1.35
XC0805C681JCC*NN-S		680pF	100	±5%	0.95
XC0805C102JCF*NN-S		1nF	100	±5%	1.35
XC0805C102JDF*NN-S		1nF	200	±5%	1.35
XC0805C272JDF*NN-S		2.7nF	200	±5%	1.35
XC0805C272JEF*NN-S		2.7nF	250	±5%	1.35
XC0805C472JCF*NN-S		4.7nF	100	±5%	1.35
XC1206C150JGF*NN-S		15pF	500	±5%	1.40
XC1206C180JGF*NN-S		18pF	500	±5%	1.40
XC1206C220JGF*NN-S		22pF	500	±5%	1.40
XC1206C220JH*NN-S		22pF	2000	±5%	1.80
XC1206C270JGF*NN-S		27pF	500	±5%	1.40
XC1206C330JGF*NN-S		33pF	500	±5%	1.40
XC1206C390JGF*NN-S		39pF	500	±5%	1.40
XC1206C470JGF*NN-S		47pF	500	±5%	1.40
XC1206C470JHF*NN-S		47pF	630	±5%	1.40
XC1206C470JIF*NN-S		47uF	1000	±5%	1.40
XC1206C470JH*NN-S	47pF	2000	±5%	1.80	
XC1206C560JGF*NN-S	3.20x1.60	56pF	500	±5%	1.40
XC1206C680JCC*NN-S		68pF	100	±5%	1.00
XC1206C680JGF*NN-S		68pF	500	±5%	1.40
XC1206C680JHF*NN-S		68pF	630	±5%	1.40
XC1206C680JIF*NN-S		68pF	1000	±5%	1.40
XC1206C820JGF*CN-S		82pF	500	±5%	1.40
XC1206C101JGF*NN-S		100pF	500	±5%	1.40
XC1206C101JHF*NN-S		100pF	630	±5%	1.40
XC1206C101JIF*NN-S		100pF	1000	±5%	1.40
XC1206C101JH*NN-S		100pF	2000	±5%	1.80
XC1206C121JGF*NN-S		120pF	500	±5%	1.40
XC1206C151JGF*NN-S		150pF	500	±5%	1.40
XC1206C181JGF*NN-S		180pF	500	±5%	1.40
XC1206C221JGF*NN-S		220pF	500	±5%	1.40
XC1206C271JGF*NN-S		270pF	500	±5%	1.40
XC1206C271JCC*NN-S		270pF	100	±5%	1.00
XC1206C331JGF*NN-S		330pF	500	±5%	1.40
XC1206C331JH*NN-S		330pF	1000	±5%	1.80
XC1206C391JCC*NN-S		390pF	100	±5%	1.00
XC1206C471JGF*NN-S		470pF	500	±5%	1.40
XC1206C471JHF*NN-S		470pF	630	±5%	1.40
XC1206C471JIF*NN-S		470pF	1000	±5%	1.40
XC1206C561JCC*NN-S		560pF	100	±5%	1.00
XC1206C561JGF*NN-S		560pF	500	±5%	1.40
XC1206C681JGF*NN-S		680pF	500	±5%	1.80
XC1206C821JH*NN-S		820pF	630	5%	1.80
XC1206C102JCC*NN-S		1nF	100	±5%	1.00
XC1206C102JGH*NN-S		1nF	500	±5%	1.80
XC1206C152JCC*NN-S		1.5nF	100	±5%	1.00
XC1206C222JCC*NN-S		2.2nF	100	±5%	1.00
XC1206C332JGH*NN-S		3.3nF	500	±5%	1.80
XC1206C332JH*NN-S		3.3nF	630	±5%	1.80
XC1206C392JCH*NN-S		3.9nF	100	±5%	1.80
XC1206C822JDH*NN-S		8.2nF	200	±5%	1.80
XC1206C822JEH*NN-S		8.2nF	250	±5%	1.80
XC1206C183JCH*NN-S		18nF	100	±5%	1.80

Part Number	Size LxW (mm)	Capacitance	Rated Voltage (Vdc)	Capacitance Tolerance	Thickness Max. (mm)	
XC1210C101JJF*NN-S	3.20x2.50	100pF	2000	±5%	1.45	
XC1210C471JJ*NN-S		470pF	2000	±5%	2.70	
XC1210C821JJ*NN-S		820pF	1000	±5%	2.70	
XC1210C103JGJ*NN-S		10nF	500	±5%	2.70	
XC1210C103JHJ*NN-S		10nF	630	±5%	2.70	
XC1210C273JDJ*NN-S		27nF	200	±5%	2.70	
XC1210C273JEJ*NN-S		27nF	250	±5%	2.70	
XC1210C563JCJ*NN-S		56nF	100	±5%	2.70	
XC1808C100JF*NN-S	4.50x2.00	10pF	3000	±5%	1.45	
XC1808C151JKI*NN-S		150pF	3000	±5%	2.20	
XC1808C221JJH*NN-S		220pF	2000	±5%	1.80	
XC1812C391JKJ*NN-S	4.50x3.20	390pF	3000	±5%	2.70	
XC1812C102JIH*NN-S		1nF	1000	±5%	1.80	
XC1812C122JII*NN-S		1.2nF	1000	±5%	2.20	
XC1812C182JII*NN-S		1.8nF	1000	±5%	2.70	
XC1812C182JII*NN-S		1.8nF	2000	±5%	2.70	
XC1812C223JGJ*NN-S		22nF	500	±5%	2.70	
XC1812C223JHJ*NN-S		22nF	630	±5%	2.70	
XC1812C473JDJ*NN-S		47nF	200	±5%	2.70	
XC1812C473JEJ*NN-S		47nF	250	±5%	2.70	
XC1812C563JCJ*NN-S		56nF	100	±5%	2.70	
XC2220C102JJJ*NN-S		5.70x5.00	1nF	2000	±5%	2.70
XC2220C102JKJ*NN-S			1nF	3000	±5%	2.70
XC2220C362JJJ*NN-S	3.6nF		1000	±5%	2.70	
XC2220C223JGJ*NN-S	22nF		500	±5%	2.70	
XC2220C223JHJ*NN-S	22nF		630	±5%	2.70	
XC2220C473JDJ*NN-S	47nF		200	±5%	2.70	
XC2220C473JEJ*NN-S	47nF		250	±5%	2.70	
XC2220C683JCJ*NN-S	68nF		100	±5%	2.70	

❖ Product Lineup (Medium High Voltage Capacitors X7R)

Part Number	Size LxW (mm)	Capacitance	Rated Voltage (Vdc)	Capacitance Tolerance	Thickness Max. (mm)
XC0603B102KC8*NN-S	1.60x0.80	1nF	100	±10%	0.90
XC0603B472KC8*NN-S		4.7nF	100	±10%	0.90
XC0603B103KC8*NN-S		10nF	100	±10%	0.90
XC0603B104KC8*NN-S		100nF	100	±10%	0.90
XC0805B221KDC*NN-S	2.00x1.25	220pF	200	±10%	0.95
XC0805B221KCA*NN-S		220pF	100	±10%	0.75
XC0805B331KDC*NN-S		330pF	200	±10%	0.95
XC0805B471KCA*NN-S		470pF	100	±10%	0.75
XC0805B102KDC*NN-S		1nF	200	±10%	0.95
XC0805B102KCA*NN-S		1nF	100	±10%	0.75
XC0805B222KDC*NN-S		2.2nF	200	±10%	0.95
XC0805B222KCA*NN-S		2.2nF	100	±10%	0.75
XC0805B332KCA*NN-S		3.3nF	100	±10%	0.75
XC0805B472KDC*NN-S		4.7nF	200	±10%	0.95
XC0805B472KCA*NN-S		4.7nF	100	±10%	0.75
XC0805B682KCA*NN-S		6.8nF	100	±10%	0.75
XC0805B103KDC*NN-S		10nF	200	±10%	0.95
XC0805B103KCA*NN-S		10nF	100	±10%	0.75
XC0805B153KEF*NN-S		15nF	250	±10%	1.35

Part Number	Size LxW (mm)	Capacitance	Rated Voltage (Vdc)	Capacitance Tolerance	Thickness Max. (mm)	
XC0805B153KDF*NN-S	2.00x1.25	15nF	200	+10%	1.35	
XC0805B153KCC*NN-S		15nF	100	+10%	0.95	
XC0805B223KCF*NN-S		22nF	100	+10%	1.35	
XC0805B473KCF*NN-S		47nF	100	+10%	1.35	
XC0805B683KCF*NN-S		68nF	100	+10%	1.35	
XC0805B154KCF*NN-S		150nF	100	+10%	1.35	
XC0805B224KCF*NN-S		220nF	100	+10%	1.35	
XC1206B221KGF*NN-S	3.20x1.60	220pF	500	+10%	1.40	
XC1206B471KGF*NN-S		470pF	500	+10%	1.40	
XC1206B471KDC*NN-S		470pF	200	+10%	1.00	
XC1206B102KJH*NN-S		1nF	2000	+10%	1.80	
XC1206B102KI F*NN-S		1nF	1000	+10%	1.40	
XC1206B102KGF*NN-S		1nF	500	+10%	1.40	
XC1206B102KHF*NN-S		1nF	630	+10%	1.40	
XC1206B152KGF*NN-S		1.5nF	500	+10%	1.40	
XC1206B152KJH*NN-S		1.5nF	2000	+10%	1.80	
XC1206B222KI F*NN-S		2.2nF	1000	+10%	1.40	
XC1206B222KDC*NN-S		2.2nF	200	+10%	1.00	
XC1206B222KGF*NN-S		2.2nF	500	+10%	1.40	
XC1206B222KJH*NN-S		2.2nF	2000	+10%	1.80	
XC1206B332KGF*NN-S		3.3nF	500	+10%	1.40	
XC1206B332KIF*NN-S		3.3nF	1000	+10%	1.40	
XC1206B472KGF*NN-S		4.7nF	500	+10%	1.40	
XC1206B472KDC*NN-S		4.7nF	200	+10%	1.00	
XC1206B682KGF*NN-S		6.8nF	500	+10%	1.40	
XC1206B103KHF*NN-S		10nF	630	+10%	1.40	
XC1206B103KGF*NN-S		10nF	500	+10%	1.40	
XC1206B103KFC*NS-S		10nF	350	+10%	1.00	
XC1206B153KDC*NN-S		15nF	200	+10%	1.00	
XC1206B153KFC*NS-S		15nF	350	+10%	1.00	
XC1206B153KCC*NN-S		15nF	100	+10%	1.00	
XC1206B153KGF*NN-S		15nF	500	+10%	1.40	
XC1206B153KHF*NN-S		15nF	630	+10%	1.40	
XC1206B223KDC*NN-S		22nF	200	+10%	1.00	
XC1206B223KCC*NN-S		22nF	100	+10%	1.00	
XC1206B223KFC*NS-S		22nF	350	+10%	1.00	
XC1206B223KGF*NN-S		22nF	500	+10%	1.80	
XC1206B223KHH*NN-S		22nF	630	+10%	1.80	
XC1206B333KDF*NN-S		33nF	200	+10%	1.40	
XC1206B333KFE*NS-S		33nF	350	+10%	1.25	
XC1206B333KCC*NN-S		33nF	100	+10%	1.00	
XC1206B333KGF*NN-S		33nF	500	+10%	1.80	
XC1206B333KHH*NN-S		33nF	630	+10%	1.80	
XC1206B473KDF*NN-S		47nF	200	+10%	1.40	
XC1206B473KFH*NS-S		47nF	350	+10%	1.80	
XC1206B473KCC*NN-S		47nF	100	+10%	1.00	
XC1206B473KEH*NN-S		47nF	250	+10%	1.80	
XC1206B683KEH*NN-S		68nF	250	+10%	1.80	
XC1206B104KDH*NN-S		100nF	200	+10%	1.80	
XC1206B104KCF*NN-S		100nF	100	+10%	1.40	
XC1206B104KEH*NN-S		100nF	250	+10%	1.80	
XC1206B154KCH*NN-S		150nF	100	+10%	1.80	
XC1206B105KCH*NN-S		1uF	100	+10%	1.80	
XC1206B155KCH*NN-S		1.5uF	100	+10%	1.80	
XC1206B225KCH*NN-S		2.2uF	100	+10%	1.80	
XC1210B102KJF*NN-S		3.20x2.50	1nF	2000	+10%	1.45
XC1210B472KHF*NN-S			4.7nF	630	+10%	1.45

Note: (*) Represents Packaging Code

Part Number	Size LxW (mm)	Capacitance	Rated Voltage (Vdc)	Capacitance Tolerance	Thickness Max. (mm)	
XC1210B472KIF*NN-S	3.20x2.50	4.7nF	1000	±10%	1.45	
XC1210B682KIF*NN-S		6.8nF	1000	±10%	1.45	
XC1210B103KCF*NN-S		10nF	100	±10%	1.45	
XC1210B153KGF*NN-S		15nF	500	±10%	1.45	
XC1210B223KGF*NN-S		22nF	500	±10%	1.45	
XC1210B333KHH*NN-S		33nF	630	±10%	1.80	
XC1210B333KGH*NN-S		33nF	500	±10%	1.80	
XC1210B473KHH*NN-S		47nF	630	±10%	1.80	
XC1210B473KDH*NN-S		47nF	200	±10%	1.80	
XC1210B473KGH*NN-S		47nF	500	±10%	1.80	
XC1210B683KDI*NN-S		68nF	200	±10%	2.20	
XC1210B104KEJ*NN-S		100nF	250	±10%	2.70	
XC1210B104KDI*NN-S		100nF	200	±10%	2.20	
XC1210B154KCF*NN-S		150nF	100	±10%	1.45	
XC1210B154KDJ*NN-S		150nF	200	±10%	2.70	
XC1210B154KEJ*NN-S		150nF	250	±10%	2.70	
XC1210B224KCH*NN-S		220nF	100	±10%	1.80	
XC1210B224KDJ*NN-S		220nF	200	±10%	2.70	
XC1210B224KEJ*NN-S		220nF	250	±10%	2.70	
XC1210B334KCH*NN-S		330nF	100	±10%	1.80	
XC1210B474KCI*NN-S		470nF	100	±10%	2.20	
XC1210B105KCJ*NN-S		1uF	100	±10%	2.70	
XC1210B155KCH*NN-S		1.5uF	100	±10%	1.80	
XC1210B225KCJ*NN-S		2.2uF	100	±10%	2.70	
XC1812B102KJF*NN-S		4.50x3.20	1nF	2000	±10%	1.45
XC1812B152KJF*NN-S			1.5nF	2000	±10%	1.45
XC1812B222KIF*NN-S			2.2nF	1000	±10%	1.45
XC1812B222KJF*NN-S			2.2nF	2000	±10%	1.45
XC1812B332KJF*NN-S			3.3nF	2000	±10%	1.45
XC1812B103KIF*NN-S			10nF	1000	±10%	1.45
XC1812B333KIJ*NN-S	33nF		1000	±10%	2.70	
XC1812B473KGF*NN-S	47nF		500	±10%	1.45	
XC1812B473KHF*NN-S	47nF		630	±10%	1.45	
XC1812B104KGI*NN-S	100nF		500	±10%	2.20	
XC1812B104KDF*NN-S	100nF		200	±10%	1.45	
XC1812B104KHI*NN-S	100nF		630	±10%	2.20	
XC1812B224KCF*NN-S	220nF		100	±10%	1.45	
XC1812B334KCF*NN-S	330nF		100	±10%	1.45	
XC1812B474KEJ*NN-S	470nF		250	±10%	2.70	
XC1812B474KCH*NN-S	470nF		100	±10%	1.80	
XC1812B474KDJ*NN-S	470nF		200	±10%	2.70	
XC1812B105KCJ*NN-S	1uF		100	±10%	2.70	
XC2220B103KJH*NN-S	5.70x5.00		10nF	2000	±10%	1.80
XC2220B473KII*NN-S			47nF	1000	±10%	2.20
XC2220B224KGJ*NN-S			220nF	500	±10%	2.70
XC2220B224KHJ*NN-S			220nF	630	±10%	2.70
XC2220B105KCH*NN-S			1uF	100	±10%	1.80
XC2220B105KDJ*NN-S			1uF	200	±10%	2.70
XC2220B105KEJ*NN-S			1uF	250	±10%	2.70
XC2220B475KCJ*NN-S			4.7uF	100	±10%	2.70

Note: (*) Represents Packaging Code

MultiLayer Ceramic Capacitors

Array Type Capacitors

❖ Features

- Reduction in required space (more than 50%)
- Reduction in cost and time for replacement of PCB.
- Reduction in amount of solder joints.
- Simple PCB design.
- Reduced waste from tape and reel packaging process.
- It protect EMI bypassing digital signal line noise.
- RoHS Compliant.

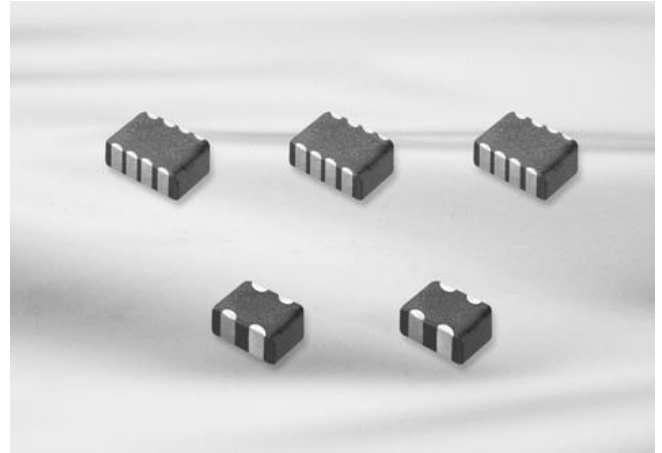

❖ Application

- A bypass for digital and analog signal line noise generated by telecommunication equipment and other common electronic.

❖ Structure, Control Code and Dimensions

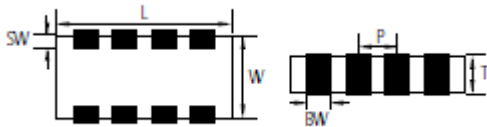

A: ARRAY (2 element)

B: ARRAY (4 element)

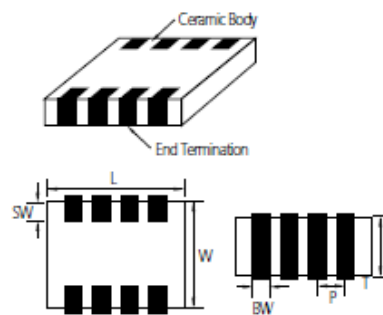
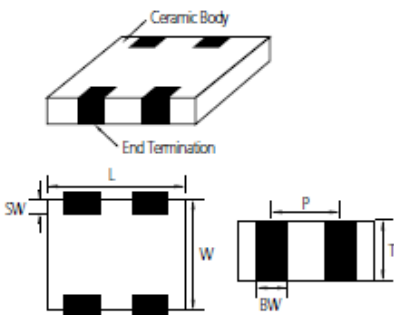

EIA Code (Inch)	Size (mm)	Dimension(mm)					
		L	W	T	BW	SW	P
0302	0906	0.90±0.05	0.60±0.05	0.45±0.05	0.25±0.05	0.15±0.1	0.45±0.05
0504	1410	1.37±0.15	1.0±0.15	0.35±0.05	0.36±0.1	0.2±0.1	0.64±0.1
				0.50±0.05			
				0.60±0.06			
				0.80±0.08			
0805	2012	2.0±0.15	1.25±0.15	0.85±0.1	0.5±0.2	0.25±0.15	1.0±0.1
0805	2012	2.0±0.15	1.25±0.15	0.85±0.1	0.25±0.1	0.25±0.15	0.5±0.1
1206	3216	3.2±0.15	1.6±0.15	0.85±0.15	0.4±0.2	0.3±0.15	0.8±0.2

❖ Array Type Capacitors Table (C0G, X5R, X7R, Y5V)

TC	Size Inch (mm)	Type	Vr (V)	Tmax (mm)	Capacitance(µF)						
					10	22	27	47	100	470	
C0G	01005(0402)	2 element	25	0.88							
	0201(0603)	4 element	50	1.00							

TC	Size Inch (mm)	Type	Vr (V)	Tmax (mm)	Capacitance(µF)													
					1	2.2	4.7	10	22	47	100	220	470	1000	2200			
X5R	0302(0906)	2 element	4	0.50														
				6.3														
	0504(1410)	2 element	10	0.88														
				6.3														
				0.66														
				0.55														
				0.40														
				0.88														
				0.66														
				0.55														
				0.40														
				0.88														
				0.66														
				0.55														
	0805(2012)	2 element	10	0.95														
				16														
X7R	0805(2012)	4 element	10	0.95														
			16															
Y5V	1206(3216)	4 element	25	1.00														
			50															
Y5V	1206(3216)	4 element	25	1.00														
			50															

❖ Product Lineup (Array Type Capacitors)

Part Number	Element Type	Size LxW (mm)	Capacitance	Rated Voltage (Vdc)	Capacitance Tolerance	Thickness Max. (mm)		
XC0504C270KA6*2N-S	2 Array	1.40x1.00	27pF	25	+10%	0.66		
XC1206C100JBC*4N-S	4 Array	3.20x1.60	10pF	50	+5%	1.00		
XC1206C150JBC*4N-S			15pF	50	+5%	1.00		
XC1206C220JBC*4N-S			22pF	50	+5%	1.00		
XC1206C270JBC*4N-S			27pF	50	+5%	1.00		
XC1206C330KBC*4N-S			33pF	50	+10%	1.00		
XC1206C390KBC*4N-S			39pF	50	+10%	1.00		
XC1206C680JBC*4N-S			68pF	50	+5%	1.00		
XC1206C820JBC*4N-S			82pF	50	+5%	1.00		
XC1206C101JBC*4N-S			100pF	50	+5%	1.00		
XC1206C151KBC*4N-S			150pF	50	+10%	1.00		
XC1206C181JBC*4N-S			180pF	50	+5%	1.00		
XC1206C331JBC*4N-S			330pF	50	+5%	1.00		
XC1206C471JBC*4N-S			470pF	50	+5%	1.00		
XC0805B471KBC*4N-S			4 Array	2.00x1.25	470pF	50	+10%	0.95
XC0805B104KOC*4N-S	100nF	16			+10%	0.95		
XC0805B104MPC*4N-S	100nF	10			+20%	0.95		
XC1206B102MBC*4N-S	4 Array	3.20x1.60	1nF	50	+20%	1.00		
XC1206B103MBC*4N-S			10nF	50	+20%	1.00		
XC1206B153KBC*4N-S			15nF	50	+10%	1.00		
XC1206B473KAC*4N-S			47nF	25	+10%	1.00		
XC1206B104KAC*4N-S			100nF	25	+10%	1.00		
XC1206B104KOC*4N-S			100nF	16	+10%	1.00		
XC0302A104KP4*2S-S	2 Array	0.90x0.60	100nF	10	+10%	0.50		
XC0302A104KQ4*2S-S			100nF	6.3	+10%	0.50		
XC0302A105MQ4*2N-S			1uF	6.3	+20%	0.50		
XC0302A105MR4*2N-S			1uF	4	+20%	0.50		
XC0504A104KA6*2N-S	2 Array	1.40x1.00	100nF	25	+10%	0.66		
XC0504A104KO6*2N-S			100nF	16	+10%	0.66		
XC0504A104KP6*2N-S			100nF	10	+10%	0.66		
XC0504A105MA5*2N-S			1uF	25	+20%	0.55		
XC0504A105KP8*2N-S			1uF	10	+10%	0.88		
XC0504A105MO3*2N-S			1uF	16	+20%	0.40		
XC0504A105MO8*2N-S			1uF	16	+20%	0.88		
XC0504A105MO5*2N-S			1uF	16	+20%	0.55		
XC0504A105MP3*2N-S			1uF	10	+20%	0.40		
XC0504A105MP5*2N-S			1uF	10	+20%	0.55		
XC0504A225KP8*2N-S			2.2uF	10	+10%	0.88		
XC0504A225KQ8*2N-S			2.2uF	6.3	+10%	0.88		
XC0805A105KOC*2N-S			2 Array	2.00x1.25	1uF	16	+10%	0.95
XC0805A105MPC*2N-S					1uF	10	+20%	0.95
XC1206F473ZBC*4N-S	4 Array	3.20x1.60	47nF	50	+80/-20%	1.00		
XC1206F104ZAC*4N-S			100nF	25	+80/-20%	1.00		

Note: (*) Represents Packaging Code

MultiLayer Ceramic Capacitors

Low ESL Type Capacitors

❖ Features

- Low ESL, good for noise reduction for high frequency.
- Highly reliable tolerance and high speed automatic chip placement on PCBs.
- Highly reliable performance.
- Highly resistant termination metal.
- Tape & reel for surface mount assembly.
- RoHS Compliant.

❖ Application

- High Speed Microprocessor
- High Frequency Digital Equipment.

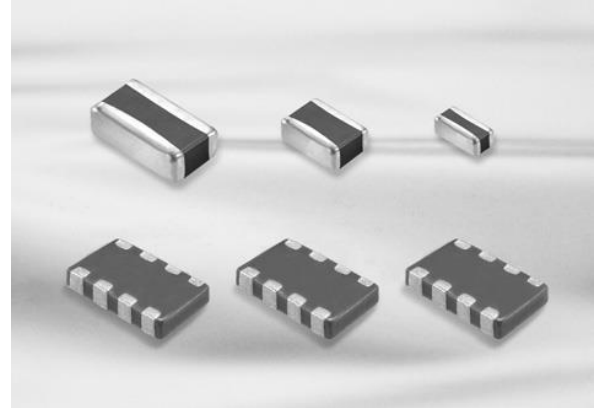

❖ LICC(Low Inductance Ceramic Capacitors)

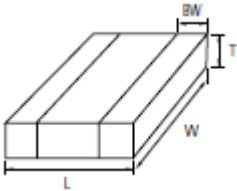

EIA Code (Inch)	Size (mm)	Dimension(mm)			
		L	W	T	BW
0204	0510	0.52±0.05	1.0±0.05	0.3±0.05	0.18±0.06s
0306	0816	0.8±0.15	1.6±0.2	0.5±0.05/-0.1	0.25±0.15

❖ SLIC(Super Low Inductance Capacitors)

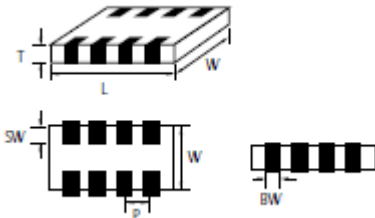

EIA Code (Inch)	Size (mm)	Dimension(mm)					
		L	W	T	BW	SW	P
0603	1608	1.6±0.1	0.8±0.1	0.5/+0.05 0.1	0.25±0.1	0.15±0.1	0.4±0.1
0805	2012	2.0±0.1	1.25±0.1	0.5/+0.05 0.1	0.25±0.15 0.1	0.2±0.15 0.1	0.5±0.1

❖ Low ESL Capacitors Table (LICC)

TC	Size Inch (mm)	Tmax (mm)	Vr (V)	Capacitance(µF)										
				0.01	0.022	0.047	0.1	0.22	0.47	1	2.2	4.7	10	
X6S /X7S /X7T	0204(0510)	0.35	2.5								X7T			
			4				X7S		X6S					
			6.3				X7S							
	0306(0816)	0.55	4								X7S			

TC	Size Inch (mm)	Tmax (mm)	Vr (V)	Capacitance(µF)										
				0.01	0.022	0.047	0.1	0.22	0.47	1	2.2	4.7	10	
X7R /X5R	0306(0816)	0.55	6.3			X7R				X5R				
			10			X7R								
			16			X7R								
			25		X7R									
			50	X7R										

❖ Low ESL Capacitors Table (SLIC)

TC	Size Inch (mm)	Tmax (mm)	Vr (V)	Capacitance(µF)								
				0.1	0.47	0.68	1	2.2	4.7	10	22	
X7R /X7S /X7T	0603(1608)	0.55	2.5									
			4				X7S					
	0805(2012)	0.55	4		X7R			X7S				
			6.3		X7R							
			16		X7R							

❖ Product Lineup (Low ESL Capacitors X7R, X6S, X7S, X7T)

Part Number	Size LxW (mm)	Capacitance	Rated Voltage (Vdc)	Capacitance Tolerance	Thickness Max. (mm)
XC0805B104MO5*JN-S	2.00x1.25	100nF	16	±20%	0.55
XC0805B684MO5*JN-S		680nF	16	±20%	0.55
XC0805B684MQ5*JN-S		680nF	6.3	±20%	0.55
XC0204X224MR3*LN-S	0.50x1.00	220nF	4	±20%	0.35
XC0204X474MR3*LN-S		470nF	4	±20%	0.35
XC0204X105MR3*LN-S		1uF	4	±20%	0.35
XC0204Y104MQ3*LN-S	0.50x1.00	100nF	6.3	±20%	0.35
XC0306Y105MR5*LN-S	0.80x1.60	1uF	4	±20%	0.55
XC0306Y225MR5*LN-S		2.2uF	4	±20%	0.55
XC0603Y474MR5*JN-S	1.60x0.80	470nF	4	±20%	0.55
XC0603Y105MR5*JN-S		1uF	4	±20%	0.55
XC0603Y225MR5*JN-S		2.2uF	4	±20%	0.55
XC0805Y105MR5*JN-S	2.00x1.25	1uF	4	±20%	0.55
XC0805Y225MR5*JN-S		2.2uF	4	±20%	0.55
XC0204Z105MS3*LN-S	0.50x1.00	1uF	2.5	±20%	0.35

Note: (*) Represents Packaging Code

MLCC Reliability Test Condition

NO	Item	Performance	Test condition				
1	Appearance	No abnormal exterior appearance	Visual Inspection through Microscope(x10)				
2	Insulation Resistance	10,000MΩ min. or 500MΩ,uF min.(or*100MΩ,uF) product whichever is smaller (Rated voltage≤16V:10,000MΩmin. or100MΩ,uF min. product whichever is smaller)	Apply the rated voltage for 60~120 sec. Rated voltage>500V: Insulation Resistance shall be measured with 500±50Vdc				
3	Capacitance	CLASS I	Within the specified tolerance				
			Capacitance	Frequency	Voltage		
			≤1,000pF	1MHz±10%	0.5 ~ 5 Vrms		
			>1,000pF	1KHz±10%			
		CLASS II	Within the specified tolerance				
			Capacitance	Frequency	Voltage		
	≤10uF	1KHz±10%	1.0±0.2Vrms				
	>10uF	120Hz±20%	0.5±0.1Vrms				
	*	1KHz±10%	0.5±0.1Vrms				
4	Q	CLASS I	Capacitance ≥ 30pF : Q ≥1,000 <30pF:Q≥400 +20xC (C : Capacitance)				
			Capacitance	Frequency	Voltage		
			≤1,000pF	1MHz±10%	0.5 ~ 5 Vrms		
			>1,000pF	1KHz±10%			
	Tan δ	CLASS II	1. Characteristic:A(X5R)				
			Rated Voltage	Spec			
			50V /35V	0.025 max / 0.05	≤10uF	1KHz±10%	1.0±0.2Vrms
			25V	0.025 max /0.05max* / 0.10 max*	>10uF	120Hz±20%	0.5±0.1Vrms
			16V	0.035 max /0.05max* / 0.10 max*	*	1KHz±10%	0.5±0.1Vrms
			≤10V	0.05 max /0.10 max*			
			2. Characteristic:B(X7R), X(X6S), Y(X7S)				
			Rated Voltage	Spec			
			50V≥/ 35V / 25V	0.025 max /0.05max* / 0.10 max*max*			
			16V	0.035 max / 0.10max*			
	≤10V	0.05 max /0.10 max*					
	3. Characteristic:F(Y5V)						
	Rated Voltage	Spec					
	50V / 35V / 25V	0.025 max / 0.05					
	16V	0.07 max /0.09 max* / 0.125 max*					
	10V	0.125 max /0.16					
	≤6.3V	0.16 max					

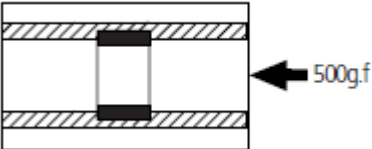
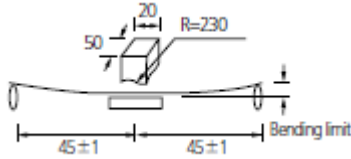
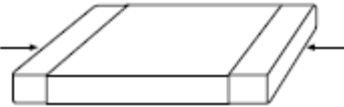
NO	Item	Performance	Test condition																
5	Withstanding Voltage	No dielectric breakdown or mechanical breakdown	Apply the specified voltage* for 1~5 sec. Charge/Discharge current limit: 50mA max. *CLASS I(Rated Voltage<100V): 300% of the rated Voltage CLASS II(Rated Voltage<100V): 250% of the rated Voltage In the case of Vr ≥100V products, following condition should be applied. 100V≤Rated Voltage<500V: 200% of the rated Voltage 500V≤Rated Voltage<1000V: 150% of the rated Voltage Rated Voltage≥1000V: 120% of the rated Voltage																
6	Temperature Characteristics of Capacitance	CLASS I <table border="1"> <thead> <tr> <th>Characteristic</th> <th>Temp.Coefficient (PPM/°C)</th> </tr> </thead> <tbody> <tr> <td>C</td> <td>0 ± 30</td> </tr> </tbody> </table>	Characteristic	Temp.Coefficient (PPM/°C)	C	0 ± 30	Capacitance shall be measured by the steps shown in the <table border="1"> <thead> <tr> <th>Step</th> <th>Temperature(°C)</th> </tr> </thead> <tbody> <tr> <td>1</td> <td>25 ± 2</td> </tr> <tr> <td>2</td> <td>Min. Operating Temp. ±2</td> </tr> <tr> <td>3</td> <td>25 ± 2</td> </tr> <tr> <td>4</td> <td>Max. Operating Temp. ±2</td> </tr> <tr> <td>5</td> <td>25 ± 2</td> </tr> </tbody> </table> (1) CLASS I Temperature Coefficient shall be calculated from the formula as below $\frac{C2 - C1}{C1 \times \Delta T} \times 10^6 [\text{ppm}/^\circ\text{C}]$ Temp. Coefficient= C1: Capacitance at step 3 C2: Capacitance at 125°C ΔT: 100°C (=125°C - 25°C) (2) CLASS II Capacitance Change shall be calculated from the formula as below $\frac{C2 - C1}{C1} \times 100(\%)$ ΔC = C1: Capacitance at step 3 C2: Capacitance at step 2 or 4	Step	Temperature(°C)	1	25 ± 2	2	Min. Operating Temp. ±2	3	25 ± 2	4	Max. Operating Temp. ±2	5	25 ± 2
Characteristic		Temp.Coefficient (PPM/°C)																	
C	0 ± 30																		
Step	Temperature(°C)																		
1	25 ± 2																		
2	Min. Operating Temp. ±2																		
3	25 ± 2																		
4	Max. Operating Temp. ±2																		
5	25 ± 2																		
	CLASS II <table border="1"> <thead> <tr> <th>Characteristic</th> <th>Capacitance Change(%) with No bias</th> </tr> </thead> <tbody> <tr> <td>A(X5R) / B(X7R)</td> <td>±15%</td> </tr> <tr> <td>X(X6S), Y(X7S)</td> <td>+22%</td> </tr> <tr> <td>Z(X7T)</td> <td>+22%~ -33%</td> </tr> <tr> <td>F(Y5V)</td> <td>+22%~ -82%</td> </tr> </tbody> </table>	Characteristic	Capacitance Change(%) with No bias	A(X5R) / B(X7R)	±15%	X(X6S), Y(X7S)	+22%	Z(X7T)	+22%~ -33%	F(Y5V)	+22%~ -82%								
Characteristic	Capacitance Change(%) with No bias																		
A(X5R) / B(X7R)	±15%																		
X(X6S), Y(X7S)	+22%																		
Z(X7T)	+22%~ -33%																		
F(Y5V)	+22%~ -82%																		
7	Adhesive Strength of Termination	No indication of peeling shall occur on the terminal electrode.	Apply 500g.f* pressure for 10±1 sec. *200g.f for 0201 *100g.f for 01005 																
8	Bending Strength	Appearance No indication of peeling shall occur	<ul style="list-style-type: none"> Bending Limit: 1mm Test Speed: 1.0mm/sec. Keep the test board at the limit point in 5 sec. Then Measure Capacitance. 																
		Capacitance <table border="1"> <thead> <tr> <th>CLASS I</th> <th>Capacitance Change</th> </tr> </thead> <tbody> <tr> <td></td> <td>CLASS I ±5% or ± 0.5 pF whichever is</td> </tr> <tr> <th>CLASS II</th> <th>Capacitance Change</th> </tr> <tr> <td>A(X5R), B(X7R), X(X6S), Y(X7S), Z(X7T)</td> <td>±12.5%</td> </tr> <tr> <td>F(Y5V)</td> <td>±30%</td> </tr> </tbody> </table>		CLASS I	Capacitance Change		CLASS I ±5% or ± 0.5 pF whichever is	CLASS II	Capacitance Change	A(X5R), B(X7R), X(X6S), Y(X7S), Z(X7T)	±12.5%	F(Y5V)	±30%						
CLASS I	Capacitance Change																		
	CLASS I ±5% or ± 0.5 pF whichever is																		
CLASS II	Capacitance Change																		
A(X5R), B(X7R), X(X6S), Y(X7S), Z(X7T)	±12.5%																		
F(Y5V)	±30%																		
9	Solderability	More than 75% of the terminal surface is to be soldered newly, so metal part does not come out or dissolve 	<table border="1"> <tbody> <tr> <td>Solder</td> <td>Sn 3Ag 0.5Cu</td> </tr> <tr> <td>Solder Temp.</td> <td>245±5°C</td> </tr> <tr> <td>Flux</td> <td>RMA Type</td> </tr> <tr> <td>Dip time</td> <td>3±0.3 sec.</td> </tr> <tr> <td>Pre heating</td> <td>At 80~120°C for 10~30 sec.</td> </tr> </tbody> </table>	Solder	Sn 3Ag 0.5Cu	Solder Temp.	245±5°C	Flux	RMA Type	Dip time	3±0.3 sec.	Pre heating	At 80~120°C for 10~30 sec.						
Solder	Sn 3Ag 0.5Cu																		
Solder Temp.	245±5°C																		
Flux	RMA Type																		
Dip time	3±0.3 sec.																		
Pre heating	At 80~120°C for 10~30 sec.																		

NO	Item	Performance	Test condition										
10	Resistance to Soldering Heat	Appearance	No mechanical damage shall occur										
		Capacitance	Characteristic	Capacitance Change									
			CLASS I	$\pm 2.5\%$ or ± 0.25 pF whichever is larger									
			CLASS II	$\pm 7.5\%$									
			F(Y5V)	$\pm 20\%$									
		Q (CLASS I)	Within the specified initial value	Solder temperature: $270 \pm 5^\circ\text{C}$ DIP TIME: 10 ± 1 sec. Each termination shall be fully immersed and preheated as below: <table border="1" style="margin: 10px auto;"> <thead> <tr> <th>Step</th> <th>Temperature($^\circ\text{C}$)</th> <th>Time (sec.)</th> </tr> </thead> <tbody> <tr> <td>1</td> <td>80~100</td> <td>60</td> </tr> <tr> <td>2</td> <td>150~180</td> <td>60</td> </tr> </tbody> </table>	Step	Temperature($^\circ\text{C}$)	Time (sec.)	1	80~100	60	2	150~180	60
		Step	Temperature($^\circ\text{C}$)		Time (sec.)								
		1	80~100		60								
2	150~180	60											
Tan δ (CLASS II)	Within the specified initial value	Leave the capacitor in ambient condition for specified time* before measurement * 24 ± 2 hours(CLASS I) 24 ± 2 hours(CLASS II)											
Insulation resistance	Within the specified initial value												
Withstanding voltage	Within the specified initial value												
11	Vibration Test		Appearance	No mechanical damage shall occur									
Capacitance		Characteristic	Capacitance Change										
		CLASS I	$\pm 2.5\%$ or ± 0.25 pF whichever is larger										
		CLASS II	$\pm 5\%$										
		F(Y5V)	$\pm 20\%$										
Q (CLASS I)		Within the specified initial value	The capacitor shall be subjected to a harmonic motion having a total amplitude of 1.5mm changing frequency from 10Hz to 55Hz and back to 10Hz in about 1 min. Repeat this for 2hours each in 3 mutually perpendicular directions.										
Tan δ CLASS II)		Within the specified initial value											
Insulation resistance		Within the specified initial value											
12	Moisture Resistance	Appearance		No mechanical damage shall occur									
Capacitance		Characteristic	Capacitance Change										
		CLASS I	$\pm 7.5\%$ or ± 0.75 pF whichever is larger										
		CLASS II	$\pm 12.5\%$										
		F(Y5V)	$\pm 30\%$										
Q (CLASS I)		Capacitance $\geq 30\text{pF}$: $Q \geq 200$ $< 30\text{pF}$: $Q \geq 100 + 10/3 \times C$ (C: Capacitance)	Applied Voltage: rated voltage Temperature: $40 \pm 2^\circ\text{C}$ Humidity: 90~95% RH Duration Time: 500+12/ 0 Hr. Charge/Discharge Current: 50mA max. Perform the initial measurement according to Note1. Perform the final measurement according to Note2.										
Tan δ (CLASS II)		1.Capacitance: A(X5R) 0.05 max / 0.075 max* (35V / 50V) 0.05 max / 0.075 max* / 0.125 max*(16V / 25V) 0.075 max / 0.125 max* ($\leq 10\text{V}$) 2.Capacitance: B(X7R), X(X6S) 0.05 max / 0.125 max* (16V / 25V / 35V / 50V \geq) 0.075 max / 0.125 max* ($\leq 10\text{V}$) 3.Capacitance: F(Y5V) 0.09 max (50V) 0.09 max / 0.125 max* (25V / 35V) 0.09 max / 0.125 max* / 0.16 max* (16V) 0.16 max / 0.195 max* (10V) 0.195 max (4V / 6.3V)											
Insulation resistance		500M Ω min. or 25M Ω ,uF min. product whichever is smaller / 12.5M Ω ,uF or over*		This test is only applied to $V_r \leq 500\text{V}$ products									

NO	Item	Performance	Test condition															
13	High Temperature Resistance	Appearance	No mechanical damage shall occur															
		Capacitance	Characteristic	Capacitance Change														
			CLASS I	$\pm 3\%$ or ± 0.3 pF whichever is larger														
			CLASS II	A(X5R), B(X7R), X(X6S), Y(X7S), Z(X7T)	$\pm 12\%$													
			F(Y5V)	$\pm 30\%$														
		Q (CLASS I)	Capacitance ≥ 30 pF : $Q \geq 350$ $10 \leq \text{Capacitance} < 30$ pF : $Q \geq 275 + 2.5 \times C$ Capacitance < 10 pF : $Q \geq 200 + 10 \times C$ (C: Capacitance)															
		Tan δ (CLASS II)	1.Capacitance: A(X5R) 0.05 max / 0.075 max* (35V / 50V) 0.05 max / 0.075 max* / 0.125 max* (16V / 25V) 0.075 max / 0.125 max* (≤ 10 V) 2.Capacitance: B(X7R), X(X6S) 0.05 max / 0.125 max* (16V / 25V / 35V / 50V \geq) 0.075 max / 0.125 max* (≤ 10 V) 3.Capacitance: F(Y5V) 0.09 max (50V) 0.09 max / 0.125 max* (25V / 35V) 0.09 max / 0.125 max* / 0.16 max* (16V) 0.16 max / 0.195 max* (10V) 0.195 max (4V / 6.3V)															
Insulation resistance	1,000M Ω min. or 50M Ω ,uF min. product whichever is smaller / 25M Ω ,uFor over*																	
14	Temperature Cycle	Appearance	No mechanical damage shall occur															
		Capacitance	Characteristic	Capacitance Change														
			CLASS I	$\pm 2.5\%$ or ± 0.25 pF whichever is larger														
			CLASS II	A(X5R), B(X7R), X(X6S), Y(X7S), Z(X7T)	$\pm 7.5\%$													
			F(Y5V)	$\pm 20\%$														
		Q (CLASS I)	Within the specified initial value															
		Tan δ (CLASS II)	Within the specified initial value															
Insulation resistance	Within the specified initial value																	
			Capacitor shall be subjected to 5 cycles. Condition for 1 cycle: <table border="1" style="margin-left: 20px;"> <thead> <tr> <th>Step</th> <th>Temperature(°C)</th> <th>Time(min.)</th> </tr> </thead> <tbody> <tr> <td>1</td> <td>min. operating temperature +0/ 3</td> <td>30</td> </tr> <tr> <td>2</td> <td>25</td> <td>2~3</td> </tr> <tr> <td>3</td> <td>Max. operating temperature +0/ 3</td> <td>30</td> </tr> <tr> <td>4</td> <td>25</td> <td>2~3</td> </tr> </tbody> </table> Leave the capacitor in ambient condition for specified time* before measurement 24 \pm 2 hours(CLASS I) 24 \pm 2 hours(CLASS II)	Step	Temperature(°C)	Time(min.)	1	min. operating temperature +0/ 3	30	2	25	2~3	3	Max. operating temperature +0/ 3	30	4	25	2~3
Step	Temperature(°C)	Time(min.)																
1	min. operating temperature +0/ 3	30																
2	25	2~3																
3	Max. operating temperature +0/ 3	30																
4	25	2~3																

NO	Recommended Soldering Method					
		Size inch(mm)	Temperature Characteristic	Capacitance	Condition	
					Flow	Reflow
15	Recommended Soldering Method By Size & Capacitance	01005(0402)				0
		0201 (0603)				
		0402 (1005)				
		0603(1608)	Class I		0	0
			Class II	C < 1uF	0	0
				C ≥ 1uF		0
		0805 (2012)	Class I		0	0
			Class II	C < 4.7uF	0	0
				C ≥ 4.7uF		0
			Array			0
		1206 (3216)	Class I		0	0
			Class II	C < 10uF	0	0
				C ≥ 10uF		0
			Array			0
		1210 (3225)				0
		1808 (4520)				0
1812 (4532)				0		
2220 (5750)				0		

Note1. Initial Measurement for Class II

Perform the heat treatment at 150°C +0/ -10°C for 1 hour. Then Leave the capacitor in ambient condition for 24±2 hours before measurement. Then perform the measurement.

Note2. Latter Measurement

1. CLASS I

Leave the capacitor in ambient condition for 24±2 hours before measurement. Then perform the measurement.

2. CLASS II

Perform the heat treatment at 150 °C +0/ -10°C for 1 hour. Then Leave the capacitor in ambient condition for 24±2 hours before measurement. Then perform the measurement.

Note3. All Size in Reliability Test Condition Section is “inch”

Note4. Camera Strobe Circuit Capacitors Should be Following a Special Reliability Test Condition.

MultiLayer Ceramic Capacitors

Automotive Type Capacitors

❖ Features

- Automotive products are manufactured in state of the art facilities Certified under ISO/TS 16949:2002.
- Automotive products meet AEC Q 200 requirements.
- Automotive products are RoHS compliant.
- InfineX terminations are suitable for all flow and reflow soldering Systems. (10/21/31 size type only)
- Automotive products meet JEDEC 020 D requirements.
- COG dielectric components contain BME and copper terminations with a Ni/Sn plated overcoat.
- X7R dielectric components have BME and soft terminations with a Ni/Sn plated overcoat.

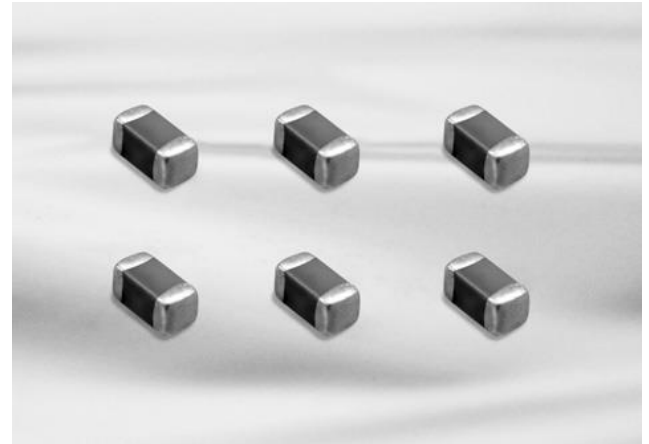

• Application

- Automotive Electronic Equipment
(Powertrain, Safety, Body & Chassis, Convenience, Infotainment)

❖ Structure and Dimensions

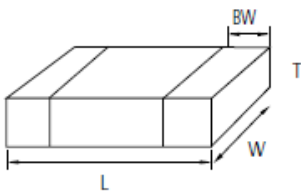

EIA Code (Inch)	Dimension(mm)			
	L	W	T	BW
0402	1.00±0.05	0.50±0.05	0.50(±0.05)	0.25±0.10
0603	1.60±0.10	0.80±0.10	0.80(±0.10)	0.3±0.2
0805	2.00±0.10	1.25±0.10	0.60(±0.10)	0.5±0.2/-0.3
			0.85(±0.10)	
			1.25(±0.10)	
1206	3.20±0.20	1.60±0.20	1.25(±0.15)	0.5±0.3
			0.85(±0.15)	
			1.15(±0.10)	
1210	3.20±0.30	2.50±0.20	1.60(±0.20)	0.60±0.30
			2.00(±0.20)	
			2.50(±0.20)	

❖ Automotive Capacitors Table (C0G, X7R)

TC	Size Inch (mm)	Thickness (mm)	Vr (V)	Capacitance(pF)			Capacitance(nF)							
				100	220	470	1	2.2	4.7	10	22	47	100	
COG	0402(1005)	0.50	50											
			100											
	0603(1608)	0.80	50											
			100											
	0805(2012)	0.60 0.85	50		271									
			100											

TC	Size Inch (mm)	Thickness (mm)	Vr (V)	Capacitance(nF)						Capacitance(uF)					
				10	22	47	100	220	470	1	2.2	4.7	10	22	
X7R	0402(1005)	0.50	10												
			16												
			25												
			50												
	0603(1608)	0.80	10												
			16												
			25												
			50												
	0805(2012)	1.25	0.85	10											
				1.25											
				0.60	25										
				0.85											
		0.60	0.85	50	1.25										
					0.60										
					0.85										
					1.25										
		0.60	0.85	100	0.60										
					0.85										
					1.25										
					1.25										
	1206(3216)	1.60	1.15	10											
				16											
		1.60	0.85	25	0.85										
					1.15										
		1.60	0.85	50	1.60										
					1.15										
		1.60	0.85	100	1.60										
					1.15										
	1210(3225)	2.70	16												

❖ Product Lineup (Automotive Capacitors COG)

Part Number	Size LxW (mm)	Capacitance	Rated Voltage (Vdc)	Capacitance Tolerance	Thickness Max. (mm)
XC0402C4R7CB5*A1-S	1.00x0.50	4.7pF	50	±0.25pF	0.55
XC0402C4R7CC5*A1-S		4.7pF	100	±0.25pF	0.55
XC0402C6R8DB5*A1-S		6.8pF	50	±0.5pF	0.55
XC0402C6R8DC5*A1-S		6.8pF	100	±0.5pF	0.55
XC0402C100JB5*A1-S		10pF	50	±5%	0.55
XC0402C100JC5*A1-S		10pF	100	±5%	0.55
XC0402C120JB5*A1-S		12pF	50	±5%	0.55
XC0402C120JC5*A1-S		12pF	100	±5%	0.55
XC0402C150JB5*A1-S		15pF	50	±5%	0.55
XC0402C150JC5*A1-S		15pF	100	±5%	0.55
XC0402C180JB5*A1-S		18pF	50	±5%	0.55
XC0402C180JC5*A1-S		18pF	100	±5%	0.55
XC0402C220JB5*A1-S		22pF	50	±5%	0.55
XC0402C220JC5*A1-S		22pF	100	±5%	0.55
XC0402C270JB5*A1-S		27pF	50	±5%	0.55
XC0402C270JC5*A1-S		27pF	100	±5%	0.55
XC0402C330JB5*A1-S		33pF	50	±5%	0.55
XC0402C330JC5*A1-S		33pF	100	±5%	0.55
XC0402C390JB5*A1-S		39pF	50	±5%	0.55
XC0402C390JC5*A1-S		39pF	100	±5%	0.55
XC0402C470JB5*A1-S		47pF	50	±5%	0.55
XC0402C470JC5*A1-S		47pF	100	±5%	0.55
XC0402C560JB5*A1-S		56pF	50	±5%	0.55
XC0402C560JC5*A1-S		56pF	100	±5%	0.55
XC0402C680JB5*A1-S		68pF	50	±5%	0.55
XC0402C680JC5*A1-S		68pF	100	±5%	0.55
XC0402C820JB5*A1-S		82pF	50	±5%	0.55
XC0402C820JC5*A1-S		82pF	100	±5%	0.55
XC0402C101JB5*A1-S		100pF	50	±5%	0.55
XC0402C101JC5*A1-S		100pF	100	±5%	0.55
XC0402C121JB5*A1-S		120pF	50	±5%	0.55
XC0402C151JB5*A1-S		150pF	50	±5%	0.55
XC0402C221JB5*A1-S		220pF	50	±5%	0.55
XC0603C4R7CB8*A1-S	1.60x0.80	4.7pF	50	±0.25pF	0.90
XC0603C4R7CC8*A1-S		4.7pF	100	±0.25pF	0.90
XC0603C6R8DB8*A1-S		6.8pF	50	±0.5pF	0.90
XC0603C6R8DC8*A1-S		6.8pF	100	±0.5pF	0.90
XC0603C100JB8*A1-S		10pF	50	±5%	0.90
XC0603C100JC8*A1-S		10pF	100	±5%	0.90
XC0603C120JB8*A1-S		12pF	50	±5%	0.90
XC0603C120JC8*A1-S		12pF	100	±5%	0.90
XC0603C150JB8*A1-S		15pF	50	±5%	0.90
XC0603C150JC8*A1-S		15pF	100	±5%	0.90
XC0603C180JB8*A1-S		18pF	50	±5%	0.90
XC0603C180JC8*A1-S		18pF	100	±5%	0.90
XC0603C220JB8*A1-S		22pF	50	±5%	0.90
XC0603C220JC8*A1-S		22pF	100	±5%	0.90
XC0603C270JB8*A1-S		27pF	50	±5%	0.90
XC0603C270JC8*A1-S		27pF	100	±5%	0.90
XC0603C330JB8*A1-S		33pF	50	±5%	0.90
XC0603C330JC8*A1-S		33pF	100	±5%	0.90
XC0603C390JB8*A1-S		39pF	50	±5%	0.90
XC0603C390JC8*A1-S		39pF	100	±5%	0.90

Part Number	Size LxW (mm)	Capacitance	Rated Voltage (Vdc)	Capacitance Tolerance	Thickness Max. (mm)	
XC0603C470JB8*A1-S	1.60x0.80	47pF	50	±5%	0.90	
XC0603C470JC8*A1-S		47pF	100	±5%	0.90	
XC0603C560JB8*A1-S		56pF	50	±5%	0.90	
XC0603C560JC8*A1-S		56pF	100	±5%	0.90	
XC0603C680JB8*A1-S		68pF	50	±5%	0.90	
XC0603C680JC8*A1-S		68pF	100	±5%	0.90	
XC0603C820JB8*A1-S		82pF	50	±5%	0.90	
XC0603C820JC8*A1-S		82pF	100	±5%	0.90	
XC0603C101JB8*A1-S		100pF	50	±5%	0.90	
XC0603C101JC8*A1-S		100pF	100	±5%	0.90	
XC0603C121JB8*A1-S		120pF	50	±5%	0.90	
XC0603C151JB8*A1-S		150pF	50	±5%	0.90	
XC0603C221JB8*A1-S		220pF	50	±5%	0.90	
XC0603C221JC8*A1-S		220pF	100	±5%	0.90	
XC0603C271JB8*A1-S		270pF	50	±5%	0.90	
XC0603C331JB8*A1-S		330pF	50	±5%	0.90	
XC0603C391JB8*A1-S		390pF	50	±5%	0.90	
XC0603C471JB8*A1-S		470pF	50	±5%	0.90	
XC0603C561JB8*A1-S		560pF	50	±5%	0.90	
XC0603C681JB8*A1-S		680pF	50	±5%	0.90	
XC0603C821JB8*A1-S		820pF	50	±5%	0.90	
XC0603C102JB8*A1-S		1.0nF	50	±5%	0.90	
XC0805C100JB6*A1-S		2.00x1.25	10pF	50	±5%	0.70
XC0805C100JC6*A1-S			10pF	100	±5%	0.70
XC0805C120JB6*A1-S			12pF	50	±5%	0.70
XC0805C120JC6*A1-S			12pF	100	±5%	0.70
XC0805C150JB6*A1-S			15pF	50	±5%	0.70
XC0805C150JC6*A1-S			15pF	100	±5%	0.70
XC0805C180JB6*A1-S			18pF	50	±5%	0.70
XC0805C180JC6*A1-S			18pF	100	±5%	0.70
XC0805C220JB6*A1-S	22pF		50	±5%	0.70	
XC0805C220JC6*A1-S	22pF		100	±5%	0.70	
XC0805C270JC6*A1-S	27pF		100	±5%	0.70	
XC0805C330JB6*A1-S	33pF		50	±5%	0.70	
XC0805C330JC6*A1-S	33pF		100	±5%	0.70	
XC0805C390JB6*A1-S	39pF		50	±5%	0.70	
XC0805C390JC6*A1-S	39pF		100	±5%	0.70	
XC0805C470JB6*A1-S	47pF		50	±5%	0.70	
XC0805C470JC6*A1-S	47pF		100	±5%	0.70	
XC0805C560JB6*A1-S	56pF		50	±5%	0.70	
XC0805C560JC6*A1-S	56pF		100	±5%	0.70	
XC0805C680JB6*A1-S	68pF		50	±5%	0.70	
XC0805C680JC6*A1-S	68pF		100	±5%	0.70	
XC0805C820JB6*A1-S	82pF		50	±5%	0.70	
XC0805C820JC6*A1-S	82pF		100	±5%	0.70	
XC0805C101JB6*A1-S	100pF		50	±5%	0.70	
XC0805C101JC6*A1-S	100pF		100	±5%	0.70	
XC0805C121JB6*A1-S	120pF		50	±5%	0.70	
XC0805C121JC6*A1-S	120pF		100	±5%	0.70	
XC0805C151JB6*A1-S	150pF		50	±5%	0.70	
XC0805C151JC6*A1-S	150pF		100	±5%	0.70	
XC0805C221JB6*A1-S	220pF		50	±5%	0.70	
XC0805C221JC6*A1-S	220pF	100	±5%	0.70		
XC0805C271JB6*A1-S	270pF	50	±5%	0.70		

Note: (*) Represents Packaging Code

Part Number	Size LxW (mm)	Capacitance	Rated Voltage (Vdc)	Capacitance Tolerance	Thickness Max. (mm)
XC0805C271JC6*A1-S	2.00x1.25	270pF	100	±0.25pF	0.70
XC0805C331JB6*A1-S		330pF	50	±0.25pF	0.70
XC0805C331JC6*A1-S		330pF	100	±0.25pF	0.70
XC0805C471JBC*A1-S		470pF	50	±0.25pF	0.95
XC0805C471JCC*A1-S		470pF	100	±0.25pF	0.95
XC0805C561JBC*A1-S		560pF	50	±0.25pF	0.95
XC0805C561JCC*A1-S		560pF	100	±0.25pF	0.95
XC0805C681JBC*A1-S		680pF	50	±0.25pF	0.95
XC0805C681JCC*A1-S		680pF	100	±0.25pF	0.95
XC0805C821JBC*A1-S		820pF	50	±0.25pF	0.95
XC0805C821JCC*A1-S		820pF	100	±0.25pF	0.95
XC0805C102JBF*A1-S		1.0nF	50	±0.25pF	1.35
XC0805C102JBC*A1-S		1.0nF	50	±0.25pF	0.95
XC0805C102JCF*A1-S		1.0nF	100	±0.25pF	1.35
XC0805C102JCC*A1-S		1.0nF	100	±0.25pF	0.95
XC0805C122JBF*A1-S		1.2nF	50	±0.25pF	1.35
XC0805C122JBC*A1-S		1.2nF	50	±0.25pF	0.95
XC0805C152JBF*A1-S		1.5nF	50	±0.25pF	1.35
XC0805C152JBC*A1-S		1.5nF	50	±0.5pF	0.95
XC0805C182JBF*A1-S		1.8nF	50	±0.5pF	1.35
XC0805C182JBC*A1-S		1.8nF	50	±0.5pF	0.95
XC0805C222JBF*A1-S		2.2nF	50	±0.5pF	1.35
XC0805C222JBC*A1-S		2.2nF	50	±0.5pF	0.95
XC0805C272JBF*A1-S		2.7nF	50	±0.5pF	1.35
XC0805C272JBC*A1-S		2.7nF	50	±0.5pF	0.95
XC0805C332JBF*A1-S		3.3nF	50	±0.5pF	1.35
XC0805C332JBC*A1-S		3.3nF	50	±5%	0.95
XC0805C392JBF*A1-S		3.9nF	50	±5%	1.35
XC0805C392JBC*A1-S		3.9nF	50	±5%	0.95
XC0805C472JBF*A1-S		4.7nF	50	±5%	1.35
XC0805C472JBC*A1-S		4.7nF	50	±5%	0.95
XC0805C562JBF*A1-S		5.6nF	50	±5%	1.35
XC0805C562JBC*A1-S		5.6nF	50	±5%	0.95
XC0805C682JBF*A1-S	6.8nF	50	±5%	1.35	
XC0805C822JBF*A1-S	8.2nF	50	±5%	1.35	
XC0805C103JBF*A1-S	10nF	50	±5%	1.35	

Note: (*) Represents Packaging Code

❖ Product Lineup (Automotive Capacitors X7R)

Part Number	Size LxW (mm)	Capacitance	Rated Voltage (Vdc)	Capacitance Tolerance	Thickness Max. (mm)
XC0402B331KB5*AV-S	1.00x0.50	330pF	50	±10%	0.55
XC0402B471KB5*AV-S		470pF	50	±10%	0.55
XC0402B681KB5*AV-S		680pF	50	±10%	0.55
XC0402B102KA5*AV-S		1.0nF	25	±10%	0.55
XC0402B102KB5*AV-S		1.0nF	50	±10%	0.55
XC0402B152KA5*AV-S		1.5nF	25	±10%	0.55
XC0402B152KB5*AV-S		1.5nF	50	±10%	0.55
XC0402B222KA5*AV-S		2.2nF	25	±10%	0.55
XC0402B222KB5*AV-S		2.2nF	50	±10%	0.55
XC0402B332KA5*AV-S		3.3nF	25	±10%	0.55
XC0402B332KB5*AV-S		3.3nF	50	±10%	0.55
XC0402B472KA5*AV-S		4.7nF	25	±10%	0.55
XC0402B472KB5*AV-S		4.7nF	50	±10%	0.55

Part Number	Size LxW (mm)	Capacitance	Rated Voltage (Vdc)	Capacitance Tolerance	Thickness Max. (mm)	
XC0402B682KA5*AV-S	1.00x0.50	6.8nF	25	±10%	0.55	
XC0402B682KB5*AV-S		6.8nF	50	±10%	0.55	
XC0402B103KA5*AV-S		10nF	25	±10%	0.55	
XC0402B103KB5*AV-S		10nF	50	±10%	0.55	
XC0402B153KA5*AV-S		15nF	25	±10%	0.55	
XC0402B153KB5*AV-S		15nF	50	±10%	0.55	
XC0402B223KA5*AV-S		22nF	25	±10%	0.55	
XC0402B223KB5*AV-S		22nF	50	±10%	0.55	
XC0402B333KO5*AV-S		33nF	16	±10%	0.55	
XC0402B473KO5*AV-S		47nF	16	±10%	0.55	
XC0402B683KO5*AV-S		68nF	16	±10%	0.55	
XC0402B104KO5*AV-S		100nF	16	±10%	0.55	
XC0603B221KC8*AW-S		1.60x0.80	220pF	100	±10%	0.90
XC0603B331KC8*AW-S			330pF	100	±10%	0.90
XC0603B471KC8*AW-S	470pF		100	±10%	0.90	
XC0603B681KC8*AW-S	680pF		100	±10%	0.90	
XC0603B102KB8*AW-S	1.0nF		50	±10%	0.90	
XC0603B102KC8*AW-S	1.0nF		100	±10%	0.90	
XC0603B152KB8*AW-S	1.5nF		50	±10%	0.90	
XC0603B152KC8*AW-S	1.5nF		100	±10%	0.90	
XC0603B222KB8*AW-S	2.2nF		50	±10%	0.90	
XC0603B222KC8*AW-S	2.2nF		100	±10%	0.90	
XC0603B332KB8*AW-S	3.3nF		50	±10%	0.90	
XC0603B332KC8*AW-S	3.3nF		100	±10%	0.90	
XC0603B472KB8*AW-S	4.7nF		50	±10%	0.90	
XC0603B472KC8*AW-S	4.7nF		100	±10%	0.90	
XC0603B682KB8*AW-S	6.8nF		50	±10%	0.90	
XC0603B682KC8*AW-S	6.8nF		100	±10%	0.90	
XC0603B103KB8*AW-S	10nF		50	±10%	0.90	
XC0603B103KC8*AW-S	10nF		100	±10%	0.90	
XC0603B153KB8*AW-S	15nF		50	±10%	0.90	
XC0603B223KB8*AW-S	22nF		50	±10%	0.90	
XC0603B333KA8*AW-S	33nF		25	±10%	0.90	
XC0603B333KB8*AW-S	33nF		50	±10%	0.90	
XC0603B473KA8*AW-S	47nF		25	±10%	0.90	
XC0603B473KB8*AW-S	47nF		50	±10%	0.90	
XC0603B683KA8*AW-S	68nF		25	±10%	0.90	
XC0603B683KB8*AW-S	68nF		50	±10%	0.90	
XC0603B104KA8*AW-S	100nF		25	±10%	0.90	
XC0603B104KB8*AW-S	100nF		50	±10%	0.90	
XC0603B154KO8*AV-S	150nF		16	±10%	0.90	
XC0603B154KA8*AV-S	150nF		25	±10%	0.90	
XC0603B224KO8*AV-S	220nF		16	±10%	0.90	
XC0603B224KA8*AV-S	220nF		25	±10%	0.90	
XC0603B334KO8*AV-S	330nF		16	±10%	0.90	
XC0603B334KA8*AV-S	330nF		25	±10%	0.90	
XC0603B474KO8*AV-S	470nF		16	±10%	0.90	
XC0603B474KA8*AV-S	470nF		25	±10%	0.90	
XC0603B684KO8*AV-S	680nF		16	±10%	0.90	
XC0603B105KO8*AV-S	1.0uF		16	±10%	0.90	
XC0805B102KC6*AW-S	2.00x1.25		1.0nF	100	±10%	0.70
XC0805B152KC6*AW-S			1.5nF	100	±10%	0.70
XC0805B222KC6*AW-S			2.2nF	100	±10%	0.70
XC0805B332KC6*AW-S			3.3nF	100	±10%	0.70
XC0805B472KC6*AW-S		4.7nF	100	±10%	0.70	
XC0805B682KC6*AW-S		6.8nF	100	±10%	0.70	
XC0805B103KC6*AW-S		10nF	100	±10%	0.70	

Part Number	Size LxW (mm)	Capacitance	Rated Voltage (Vdc)	Capacitance Tolerance	Thickness Max. (mm)	
XC0805B153KC6*AW-S	2.00x1.25	15nF	100	±10%	0.70	
XC0805B223KC6*AW-S		22nF	100	±10%	0.70	
XC0805B333KCC*AW-S		33nF	100	±10%	0.95	
XC0805B473KCC*AW-S		47nF	100	±10%	0.95	
XC0805B683KCC*AW-S		68nF	100	±10%	0.95	
XC0805B104KBF*AW-S		100nF	50	±10%	1.35	
XC0805B104KBC*AW-S		100nF	50	±10%	0.95	
XC0805B104KCF*AW-S		100nF	100	±10%	1.35	
XC0805B104KCC*AW-S		100nF	100	±10%	0.95	
XC0805B154KAF*AV-S		150nF	25	±10%	1.35	
XC0805B154KBF*AV-S		150nF	50	±10%	1.35	
XC0805B224KAF*AV-S		220nF	25	±10%	1.35	
XC0805B224KBF*AV-S		220nF	50	±10%	1.35	
XC0805B334KAF*AV-S		330nF	25	±10%	1.35	
XC0805B334KBF*AV-S		330nF	50	±10%	1.35	
XC0805B474KOF*AV-S		470nF	16	±10%	1.35	
XC0805B474KAF*AV-S		470nF	25	±10%	1.35	
XC0805B474KBF*AV-S		470nF	50	±10%	1.35	
XC0805B684KOF*AV-S		680nF	16	±10%	1.35	
XC0805B684KAF*AV-S		680nF	25	±10%	1.35	
XC0805B105KOF*AV-S		1.0uF	16	±10%	1.35	
XC0805B105KAF*AV-S		1.0uF	25	±10%	1.35	
XC0805B225KPF*AV-S		2.2uF	10	±10%	1.35	
XC0805B225KOF*AV-S		2.2uF	16	±10%	1.35	
XC0805B335KPQ*AV-S		3.3uF	10	±10%	1.40	
XC0805B475KPQ*AV-S		4.7uF	10	±10%	1.40	
XC1206B104KBP*AW-S		3.20x1.60	100nF	50	±10%	1.25
XC1206B104KBC*AV-S			100nF	50	±10%	1.00
XC1206B154KBP*AW-S			150nF	50	±10%	1.25
XC1206B224KBP*AW-S			220nF	50	±10%	1.25
XC1206B334KBH*AW-S			330nF	50	±10%	1.80
XC1206B474KBH*AW-S			470nF	50	±10%	1.80
XC1206B684KBH*AW-S			680nF	50	±10%	1.80
XC1206B105KAP*AW-S	1.0uF		25	±10%	1.25	
XC1206B105KBH*AW-S	1.0uF		50	±10%	1.80	
XC1206B155KAH*AV-S	1.5uF		25	±10%	1.80	
XC1206B155KBH*AV-S	1.5uF		50	±10%	1.80	
XC1206B225KOH*AV-S	2.2uF		16	±10%	1.80	
XC1206B225KAH*AV-S	2.2uF		25	±10%	1.80	
XC1206B225KBH*AV-S	2.2uF		50	±10%	1.80	
XC1206B335KOH*AV-S	3.3uF		16	±10%	1.80	
XC1206B335KAH*AV-S	3.3uF		25	±10%	1.80	
XC1206B475KOH*AV-S	4.7uF		16	±10%	1.80	
XC1206B475KAH*AV-S	4.7uF		25	±10%	1.80	
XC1206B685KOH*AV-S	6.8		16	±10%	1.80	
XC1206B106KOH*AV-S	22		16	±10%	1.80	
XC1210B226KOJ*AV-S	3.20x2.50		10.0	16	+10%	2.70

Note: (*) Represents Packaging Code

MLCC Reliability Test Condition (Automotive Capacitors)

NO	Item		Performance	Test condition	
1	Pre and Post Stress Electrical Test				
2	High Temperature Exposure	Appearance	No abnormal exterior appearance	Unpowered, 1000hrs@T=150°C Measurement at 24±2hrs after test conclusion Initial Measurement Perform a heat treatment at 150 +0/-10°C for 1hr after soldering process. And then let sit for 24±2hrs at room temperature. Perform the initial measurement. Final measurement Let sit for 24±2hrs at room temperature after test conclusion, then measure.	
		Capacitance Change	CLASS I		Within ±2.5% or 0.25pF, (Whichever is larger)
			CLASS II		Within ±10%
		Q	CLASS I		Capacitance ≥ 30pF : Q ≥ 1,000 <30pF : Q ≥ 400 +20xC (C:Capacitance)
		Tanδ	CLASS II		Rated Voltage ≥ 25V : 0.03 max ≥ 16V : 0.05 max ≥ 10V : 0.075 max *1)
IR		More than 10,000MΩ or 500MΩ x uF (Whichever is smaller) *1)			
3	Temperature Cycling	Appearance	No abnormal exterior appearance	1000Cycles Initial Measurement Perform a heat treatment at 150 +0/-10°C for 1hr after soldering process. And then let sit for 24±2hrs at room temperature. Perform the initial measurement. Final measurement Let measure within 24hrs at room temperature after test conclusion, then measure. Measurement at 24±2hrs after test conclusion	
		Capacitance Change	CLASS I		Within ±2.5% or 0.25pF, (Whichever is larger)
			CLASS II		Within ±10%
		Q	CLASS I		Capacitance ≥ 30pF : Q ≥ 1,000 <30pF : Q ≥ 400 +20xC (C:Capacitance)
		Tanδ	CLASS II		Rated Voltage ≥ 25V : 0.03 max ≥ 16V : 0.05 max ≥ 10V : 0.075 max *1)
IR		More than 10,000MΩ or 500MΩ x uF (Whichever is smaller) *1)			
4	Destructive Physical Analysis		No defects or abnormalities	Per EIA 469	
5	Moisture Resistance	Appearance	No abnormal exterior appearance	10Cycles, t=24hrs/cycle Heat (25~65°C) and humidity (80~98%), Unpowered measurement at 24±2hrs after test conclusion	
		Capacitance Change	CLASS I		Within ±2.5% or 0.25pF, (Whichever is larger)
			CLASS II		Within ±12.5%
		Q	CLASS I		Capacitance ≥ 30pF : Q ≥ 350 10≤Capacitance<30pF : Q ≥ 275+(5/2)xC Capacitance<10pF : Q ≥ 200+10xC (C : Capacitance)
		Tanδ	CLASS II		Rated Voltage ≥ 25V : 0.03 max ≥ 16V : 0.05 max ≥ 10V : 0.075 max *1)
IR		More than 10,000MΩ or 500MΩ x uF (Whichever is smaller) *1)			

Step	Temperature(°C)	Time(min.)
1	min. operating Temperature +2	15±3
2	25±2	1
3	max. operating Temperature +2	15±3
4	25±2	1

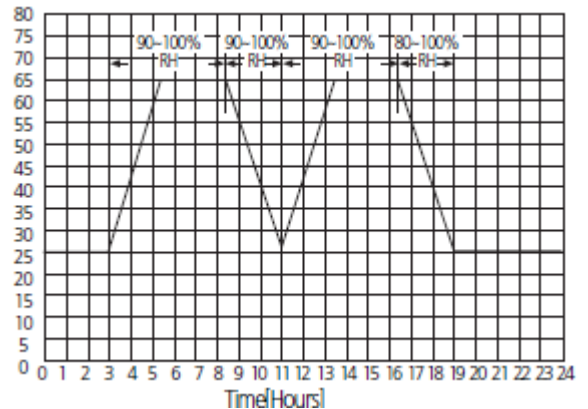

*1) : Indicates typical specification. Please refer to individual specifications.

NO	Item		Performance	Test condition						
6	Biased Humidity	Appearance	No abnormal exterior appearance	1000hrs 85°C/85%RH, Rated Voltage and 1.3~1.5V, (add 100kohm resistor) Initial Measurement Perform a heat treatment at 150 +0/-10°C for 1hr after soldering process. And then let sit for 24±2hrs at room temperature. Perform the initial measurement. Final measurement Perform a heat treatment at 150 +0/-10°C for 1hr after soldering process. And then let sit for 24±2hrs at room temperature. Perform the initial measurement. Perform the initial measurement. Measurement at 24±2hrs after test conclusion The charge/discharge current is less than 50mA.						
		Capacitance Change	CLASS I		Within ±2.5% or 0.25pF, (Whichever is larger)					
			CLASS II		Within ±12.5%					
		Q	CLASS I		Capacitance ≥ 30pF : Q ≥ 200 < 30pF : Q ≥ 100 + (10/3)xC (C : Capacitance)					
		Tanδ	CLASS II		Rated Voltage ≥ 25V : 0.035 max ≥ 16V : 0.05 max ≥ 10V : 0.075 max *1)					
IR		More than 500MΩ or 25MΩ x uF (Whichever is smaller) *1)								
7	High Temperature Operating Life	Appearance	No abnormal exterior appearance	1000hrs @ TA=125°C, 200% Rated Voltage, *2). Initial Measurement Perform a heat treatment at 150 +0/-10°C for 1hr after soldering process. And then let sit for 24±2hrs at room temperature. Perform the initial measurement. Final measurement Perform a heat treatment at 150 +0/-10°C for 1hr after soldering process. And then let sit for 24±2hrs at room temperature. Perform the initial measurement. Perform the initial measurement. Measurement at 24±2hrs after test conclusion The charge/discharge current is less than 50mA.						
		Capacitance Change	CLASS I		Within ±2.5% or 0.25pF, (Whichever is larger)					
			CLASS II		Within ±12.5%					
		Q	CLASS I		Capacitance ≥ 30pF : Q ≥ 350 ≥ 10pF : Q ≥ 275 + (5/2)xC < 10pF : Q ≥ 200 + 10xC (C : Capacitance)					
		Tanδ	CLASS II		Rated Voltage ≥ 25V : 0.03 max ≥ 16V : 0.05 max ≥ 10V : 0.075 max *1)					
IR		More than 1,000MΩ or 50MΩ x uF (Whichever is smaller) *1)								
8	External Visual		No abnormal exterior appearance	Microscope (x10)						
9	Physical Dimensions		Within the specified dimensions	Using the calipers						
10	Mechanical Shock	Appearance	No abnormal exterior appearance	Three shocks in each direction should be applied along 3 mutually perpendicular axes of the test specimen (18 Shocks) <table border="1" data-bbox="974 1449 1559 1512"> <thead> <tr> <th>Peak value</th> <th>Duration</th> <th>Wave</th> </tr> </thead> <tbody> <tr> <td>1,500G</td> <td>0.5ms</td> <td>Half sine</td> </tr> </tbody> </table> Initial Measurement Perform a heat treatment at 150 +0/-10°C for 1hr after soldering process. And then let sit for 24±2hrs at room temperature. Perform the initial measurement. Final measurement Let measure within 24hrs at room temperature after test conclusion.	Peak value	Duration	Wave	1,500G	0.5ms	Half sine
		Peak value	Duration		Wave					
		1,500G	0.5ms		Half sine					
		Capacitance Change	CLASS I		Within ±2.5% or 0.25pF, (Whichever is larger)					
			CLASS II		Within ±10%					
Q	CLASS I	Capacitance ≥ 30pF : Q ≥ 1,000 < 30pF : Q ≥ 400 + 20xC (C : Capacitance)								
Tanδ	CLASS II	Rated Voltage ≥ 25V : 0.03 max ≥ 16V : 0.05 max ≥ 10V : 0.075 max *1)								
IR		More than 10,000MΩ or 500MΩ x uF (Whichever is smaller) *1)								

*1) : Indicates typical specification. Please refer to individual specifications.

*2) : Some of the parts are applicable in rated voltage x150%, please refer to individual specifications.

NO	Item		Performance	Test condition	
11	Vibration	Appearance	No abnormal exterior appearance	5g's for 20min., 12cycles each of 3 orientations, Use 8" 5" PCB 0.031" Thick 7 secure points on one long side and 2 secure points at corners of opposite sides. Parts mounted within 2" from any secure point. Test from 10~2000Hz. Initial Measurement Perform a heat treatment at 150 +0/-10°C for 1hr after soldering process. And then let sit for 24±2hrs at room temperature. Perform the initial measurement. Final measurement Let measure within 24hrs at room temperature after test conclusion.	
		Capacitance Change	CLASS I		Within ±2.5% or 0.25pF, (Whichever is larger)
			CLASS II		Within ±10%
		Q	CLASS I		Capacitance ≥ 30pF : Q ≥1,000 <30pF : Q ≥400 +20xC (C : Capacitance)
		Tanδ	CLASS II		Rated Voltage ≥ 25V : 0.025 max ≥ 16V : 0.035 max ≥ 10V : 0.05 max *1)
		IR			More than 10,000MΩ or 500MΩ x uF (Whichever is smaller) *1)
12	Resistance to Solder Heat	Appearance	No abnormal exterior appearance	Solder pot: 260±5°C, 10±1sec. Initial Measurement Perform a heat treatment at 150 +0/-10°C for 1hr after soldering process. And then let sit for 24±2hrs at room temperature. Perform the initial measurement. Final Measurement Let sit for 24±2hrs at room temperature after test conclusion, then measure.	
		Capacitance Change	CLASS I		Within ±2.5% or 0.25pF, (Whichever is larger)
			CLASS II		Within ±10%
		Q	CLASS I		Capacitance ≥ 30pF : Q ≥1,000 <30pF : Q ≥400 +20xC (C : Capacitance)
		Tanδ	CLASS II		Rated Voltage ≥ 25V : 0.025 max ≥ 16V : 0.035 max ≥ 10V : 0.05 max *1)
		IR			More than 10,000MΩ or 500MΩ x uF (Whichever is smaller) *1)
13	Thermal Shock	Appearance	No abnormal exterior appearance	-55°C/+125°C Note: Number of cycles required - 300, Maximum transfer time - 20 sec, Dwell time - 15min. Air - Air.	
		Capacitance Change	CLASS I		Within ±2.5% or 0.25pF, (Whichever is larger)
			CLASS II		Within ±10%
		Q	CLASS I		Capacitance ≥ 30pF : Q ≥1,000 <30pF : Q ≥400 +20xC (C : Capacitance)
		Tanδ	CLASS II		Rated Voltage ≥ 25V : 0.025 max ≥ 16V : 0.035 max ≥ 10V : 0.05 max *1)
		IR			More than 10,000MΩ or 500MΩ x uF (Whichever is smaller) *1)

*1) : Indicates typical specification. Please refer to individual specifications.

NO	Item		Performance	Test condition																		
14	ESD	Appearance	No abnormal exterior appearance	AEC Q200 002 Initial Measurement Perform a heat treatment at 150 +0/-10°C for 1hr after soldering process. And then let sit for 24±2hrs at room temperature. Perform the initial measurement. Final measurement Perform a heat treatment at 150 +0/-10°C for 1hr after soldering process. And then let sit for 24±2hrs at room temperature. Perform the initial measurement.																		
		Capacitance Change	CLASS I		Within ±2.5% or 0.25pF, (Whichever is larger)																	
			CLASS II		Within ±10%																	
		Q	CLASS I		Capacitance ≥ 30pF : Q ≥1,000 <30pF : Q ≥400 +20xC (C : Capacitance)																	
		Tanδ	CLASS II		Rated Voltage ≥ 25V : 0.025 max ≥ 16V : 0.035 max ≥ 10V : 0.05 max *1)																	
IR		More than 10,000MΩ or 500MΩ x uF (Whichever is smaller) *1)																				
15	Solderability		95% of the terminations is to be soldered evenly and continuously	a) Preheat at 155°C for 4 hrs, Immerse in solder for 5s at 235±5°C b) Steam aging for 8 hrs, Immerse in solder for 5s at 235±5°C c) Steam aging for 8 hrs, Immerse in solder for 120s at 260±5°C solder : a solution ethanol and rosin																		
16	Electrical Characterization	Capacitance	Within specified tolerance	The Capacitance /D.F. should be measured at 25°C, *A capacitor prior to measuring the capacitance is heat treated at 150 +0/-10°C and maintained in ambient air for 24±2hrs. <table border="1" data-bbox="998 1008 1567 1186"> <thead> <tr> <th>Class</th> <th>Capacitance</th> <th>Frequency</th> <th>Vrms</th> </tr> </thead> <tbody> <tr> <td rowspan="2">CLASS I</td> <td>1000pF</td> <td>1MHz±10%</td> <td>0.5~5Vrms</td> </tr> <tr> <td>1000pF</td> <td>1KHz±10%</td> <td>1.0 ±0.2Vrms</td> </tr> <tr> <td rowspan="2">Class II</td> <td>10</td> <td>1KHz±10%</td> <td>1.0 ±0.2Vrms</td> </tr> <tr> <td>10</td> <td>120Hz± 20%</td> <td>0.5 ±0.1Vrms</td> </tr> </tbody> </table>	Class	Capacitance	Frequency	Vrms	CLASS I	1000pF	1MHz±10%	0.5~5Vrms	1000pF	1KHz±10%	1.0 ±0.2Vrms	Class II	10	1KHz±10%	1.0 ±0.2Vrms	10	120Hz± 20%	0.5 ±0.1Vrms
		Class	Capacitance		Frequency	Vrms																
		CLASS I	1000pF		1MHz±10%	0.5~5Vrms																
			1000pF		1KHz±10%	1.0 ±0.2Vrms																
		Class II	10		1KHz±10%	1.0 ±0.2Vrms																
			10		120Hz± 20%	0.5 ±0.1Vrms																
		Q	CLASS I		Capacitance ≥ 30pF : Q ≥1,000 <30pF : Q ≥400 +20xC (C : Capacitance)																	
Tanδ	CLASS II	Rated Voltage ≥ 25V : 0.025 max ≥ 16V : 0.035 max ≥ 10V : 0.05 max *1)																				
IR@25°C	CLASS I	More than 100,000MΩ or 1000MΩ x uF (Whichever is smaller)																				
	CLASS II	More than 10,000MΩ or 500MΩ x uF (Whichever is smaller)																				
R@125°C	CLASS I	More than 10,000MΩ or 100MΩ x uF (Whichever is smaller)																				
	CLASS II	More than 1,000MΩ or 10MΩ x uF (Whichever is smaller)																				
Dielectric Strength		No dielectric breakdown or mechanical breakdown																				
17	Board Flex	Appearance	No abnormal exterior appearance	Bending to the limit for 5 seconds Limit : Class I 3mm Class II 2mm																		
		Capacitance Change	CLASS I		Within ±5.0% or 0.5pF, (Whichever is larger)																	
			CLASS II		Within ±10%																	
18	Terminal Strength(SMD)	Appearance	No abnormal exterior appearance	18N, for 60±1 sec. * 0603(1608) 10N, 0402(1005) 2N																		
		Capacitance Change	CLASS I		Within ±2.5% or 0.25pF, (Whichever is larger)																	
			CLASS II		Within ±10%																	

*1) : Indicates typical specification. Please refer to individual specifications.

NO	Item			Performance	Test condition																		
19	Beam Load			Destruction value should be exceed Chip Length $\leq 2.5\text{mm}$ a) Chip Thickness $> 0.5\text{mm}$: 20N b) Chip Thickness $\leq 0.5\text{mm}$: 8N Chip Length $\geq 3.2\text{mm}$ a) Chip Thickness $\geq 1.25\text{mm}$: 54.5N b) Chip Thickness $< 1.25\text{mm}$: 15N	Beam speed Chip Length ≤ 2.5 , $0.5 \pm 0.05\text{mm /sec}$ Chip Length ≥ 3.2 , $2.5 \pm 0.25\text{mm /sec}$																		
20	Capacitance Temperature Characteristics	Capacitance Change	CLASS I	0 ± 30 ppm/°C	<table border="1"> <thead> <tr> <th>Step</th> <th>Temperature(°C)</th> <th>Time(min)</th> </tr> </thead> <tbody> <tr> <td>1</td> <td>25 ± 2</td> <td>1</td> </tr> <tr> <td>2</td> <td>Min. Operating Temp. ± 2</td> <td>15 ± 3</td> </tr> <tr> <td>3</td> <td>25 ± 2</td> <td>1</td> </tr> <tr> <td>4</td> <td>Max. Operating Temp. ± 2</td> <td>15 ± 3</td> </tr> <tr> <td>5</td> <td>25 ± 2</td> <td>1</td> </tr> </tbody> </table>	Step	Temperature(°C)	Time(min)	1	25 ± 2	1	2	Min. Operating Temp. ± 2	15 ± 3	3	25 ± 2	1	4	Max. Operating Temp. ± 2	15 ± 3	5	25 ± 2	1
Step			Temperature(°C)	Time(min)																			
1		25 ± 2	1																				
2		Min. Operating Temp. ± 2	15 ± 3																				
3	25 ± 2	1																					
4	Max. Operating Temp. ± 2	15 ± 3																					
5	25 ± 2	1																					
CLASS II	Within $\pm 15\%$																						
Temperature Coefficient	CLASS I	0 ± 30 ppm/°C																					
Capacitance Drift	CLASS I	Within $\pm 0.2\%$ or 0.05pF , (Whichever is larger)																					

Multi Layer Ceramic Capacitors – Packing Specification

Cardboard Paper Tape(4mm)

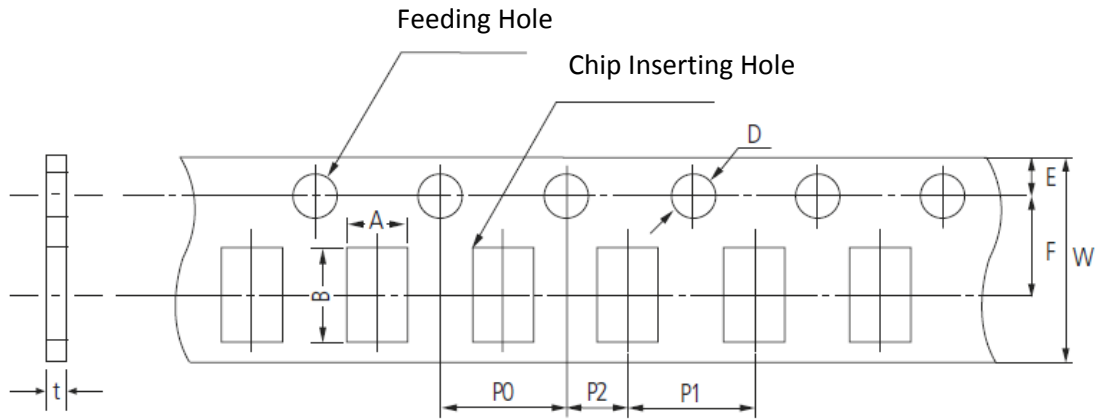

UNIT: Inch (mm)

Symbol		A	B	W	F	E	P1	P2	P0	D	t
Size Inch (mm)											
Dimension	01005 (0402)	1.3±0.2	1.7±0.2	8.0±0.3	3.5±0.05	1.75±0.1	4.0±0.1	2.0±0.05	4.0±0.1	∅ 1.5 +0.1/-0	1.1 Below
	0603 0306 (1608) (0816)	1.1±0.2	1.9±0.2								
	0805 0508 (2012) (1220)	1.6±0.2	2.4±0.2								
	1206 0612 (3216) (1632)	2.0±0.2	3.6±0.2								

Cardboard Paper Tape(2mm)

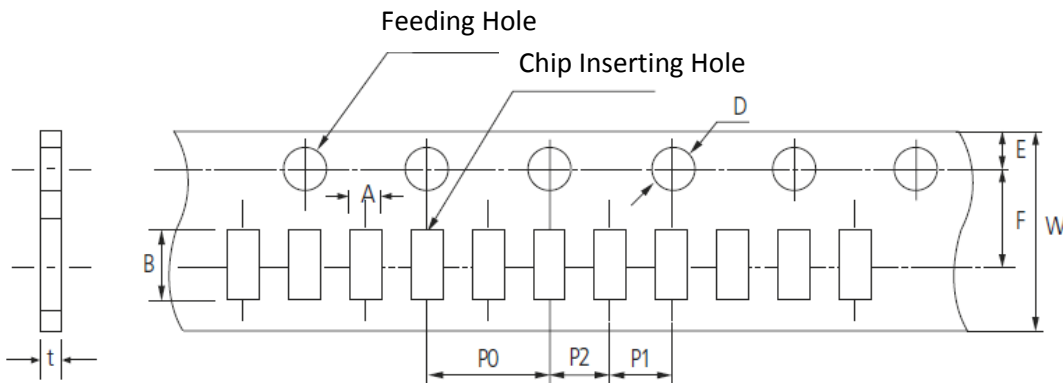

UNIT: Inch (mm)

Symbol		A	B	W	F	E	P1	P2	P0	D	t
Size Inch (mm)											
Dimension	01005 (0402)	0.25±0.02	0.45±0.02	8.0±0.3	3.5±0.05	1.75±0.1	2.0±0.05	2.0±0.05	4.0±0.1	Ø 1.5 +0.1/-0.03	0.25 ±0.02
	0201 (0603)	0.38±0.03	0.68±0.03								0.37 ±0.03
	0402 (1005)	0.62 ±0.05	1.12 ±0.05								0.37 ±0.05
	0204 (0510)	0.62 +0.05 /-0.10	1.12 +0.05 /-0.10								0.60 ±0.05 0.37 ±0.03

Embossed Plastic Tape

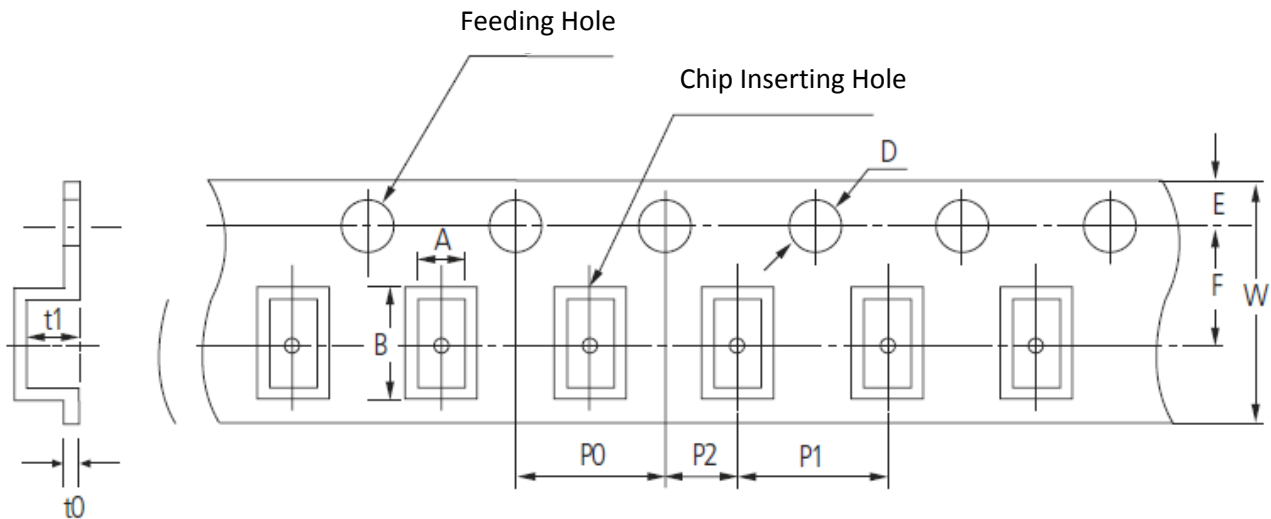

UNIT: Inch (mm)

Symbol		A	B	W	F	E	P1	P2	P0	D	t1	t0
Size Inch (mm)												
Dimension	01005 (0402)	0.25±0.02	0.45±0.02	4.0±0.05	1.8±0.02	0.9±0.05	1.0±0.02	1.0±0.02	2.0±0.04	∅ 0.8 ±0.04	0.25 ±0.02	0.5 max
	0603 (1608)	1.05±0.15	1.9±0.15	8.0±0.3	3.5±0.05	1.75±0.1	4.0±0.1	2.0±0.05	4.0±0.1	∅ 1.5 +0.1/ -0.03	2.9 max	0.6 Below
	0805 (2012)	1.45±0.2	2.3±0.2									
	1206 (3216)	1.9±0.2	3.5±0.2									
	1210 (3225)	2.8±0.2	3.6±0.2	12.0±0.3	5.60±0.05	8.0±0.1	3.8 max					
	1808 (4520)	2.3±0.2	4.9±0.2									
	1812 (4532)	3.6±0.2	4.9±0.2	0.8±0.3	3.5±0.05	4.0±0.1	2.5 max					
	2220 (5750)	5.5±0.2	6.2±0.2									
	0204 (5010)	0.62±0.05 /-0.10	1.12±0.05 /-0.10									
	0306 (0816)	1.1±0.2	1.9±0.2	1.45±0.2	2.3±0.2	2.0±0.2	3.6±0.2					
	0508 (1220)	1.45±0.2	2.3±0.2									
	0612 (1632)	2.0±0.2	3.6±0.2									

Peeling off of Cover Tape

10 g.f ≤ Peel off force ≤ 70 g.f

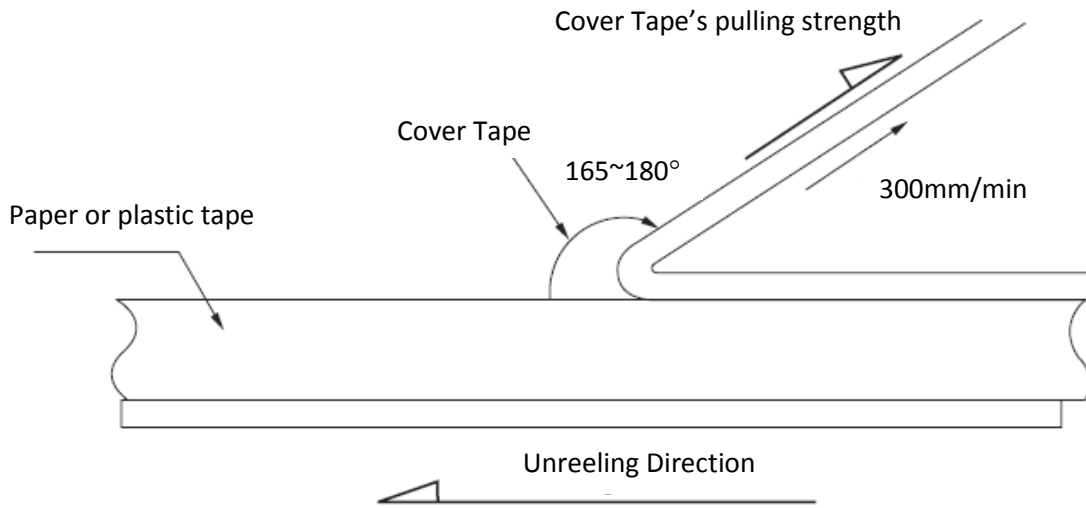

Taping Size

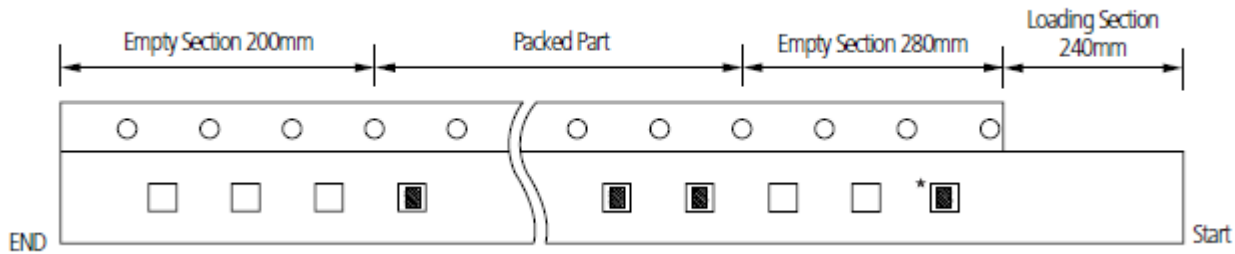

- The chip is only use for identifying the label and packaged products.
Please don't use the chip.

Unit: kpcs

Size Inch (mm)	T code	Quantity & Packing Code								
		Cardboard Paper Type					Embossed Plastic Type			
		C (7"reel)	H (7"reel)	O (10"reel)	D (13"reel)	L (13"reel)	E (7"reel)	G (7"reel)	F (13"reel)	S (10"reel)
01005(0402)	2	20			100		50	50		
0201(0603)	3	10	15	30	50					
0402(1005)	3	10	15	30	50					
	5	10	15	30	50	40				
0504(1410)	8	4		10	10	15				
0603(1608)	5	4		10	10					
	8	4		10	10	15	3	3		
0604(1610)	D						3	3	10	6
0805(2012)	A, C	4		10	10	15				
	E, F, Q						2	2	10	6
1206(3216)	C	4		10	10	15				
	E, F, P						2	2	10	6
	H						2	2	8	4
1210(3225)	9, D, C, O						2	2	10	
	E, F, M						2	2	10	
	H, T						2	2	8	4
	I, U						2	2	4	
	J, V						1	1	4	
	S						2	2	8	
1808(4520)	F						2	2		
1812(4532)	F, H, I						1	1	4	
	L, J								2	
2220(5750)	H, I, J								2	

Reel Dimensions

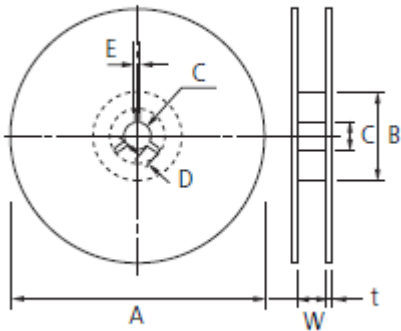

Unit: mm

Symbol	Tape Width	A	B	C	D	E	W	t
7" Reel	8mm	$\varnothing 180+0/-3$	$\varnothing 60\pm 1.0$	$\varnothing 13\pm 0.3$	4 ± 0.2	2.0 ± 0.5	9 ± 0.5	1.2 ± 0.2
	12mm	$\varnothing 180+0/-3$	$\varnothing 60+1/-0$	$\varnothing 13\pm 0.3$	4 ± 0.2	2.0 ± 0.5	13 ± 0.5	1.2 ± 0.2
10" Reel	8mm	$\varnothing 258+0/-3$	$\varnothing 80+1/-0$	$\varnothing 13\pm 0.3$	4 ± 0.2	2.0 ± 0.5	9 ± 0.5	1.8 ± 0.2
	12mm	$\varnothing 258+0/-3$	$\varnothing 80+1/-0$	$\varnothing 13\pm 0.3$	4 ± 0.2	2.0 ± 0.5	13 ± 0.5	1.8 ± 0.2
13" Reel	8mm	$\varnothing 330\pm 2.0$	$\varnothing 80\pm 1.0$	$\varnothing 13\pm 0.3$	4 ± 0.2	2.0 ± 0.5	9 ± 0.5	2.2 ± 0.2
	12mm	$\varnothing 330\pm 2.0$	$\varnothing 80\pm 1.0$	$\varnothing 13\pm 0.3$	4 ± 0.2	2.0 ± 0.5	13 ± 0.5	2.2 ± 0.2

Bulk Case Packaging

- Bulk case packaging can reduce the stock space and transportation costs.
- The bulk feeding system can increase the productivity.
- It can eliminate the components loss.

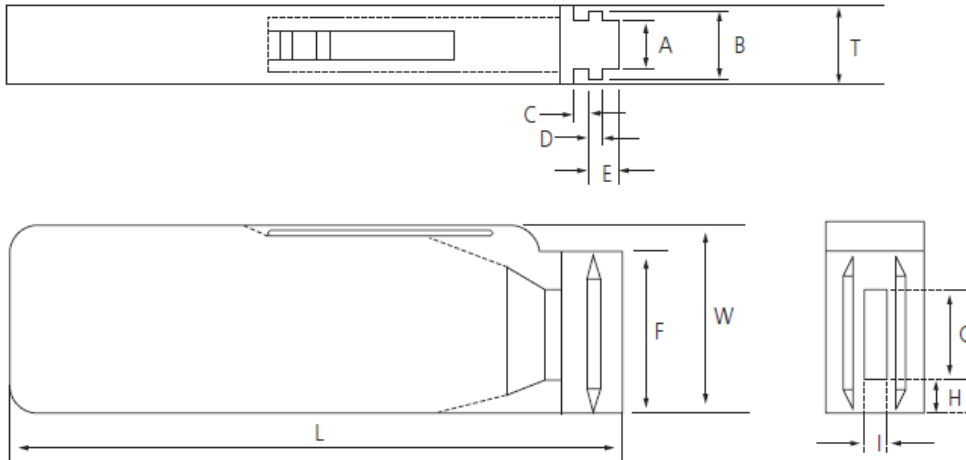

Unit: mm

Symbol	A	B	T	C	D	E	F	W	G	H	L	I
Dimension	6.8±0.1	8.8±0.1	12±0.1	1.5 +0.1/-0	2.0 +0/-0.1	3.0 +0.2/-0	31.5 +0.2/-0	36 +0/-0.2	19±0.35	7±0.35	110±0.7	5±0.35

❖ **QUANTITY**

Unit: Inch (mm) and pcs

Size Inch (mm)	0402(1005)	0603(1608)	0805(2012)	
			T≤0.85mm	T≥1.0mm
Quantity	50,000	10,000 or 15,000	10,000	5,000

MLCC Application Manual for Surface Mounting

1.Storage of products

1 1. Storage Environment

Tape packing materials are designed to withstand long term storage, but they will degrade more rapidly in the presence of high temperature or high humidity. Therefore, the products must be stored in an ambient 5~40°C with a relative humidity of 20~70%. Allowable storage period is within 6 months from the outgoing date of delivery.

1 2. Corrosive Gases

Since sulfur and chlorine may degrade the solderability of the end termination, it is important to store the capacitors in an environment free of these gases.

1 3. Temperature Fluctuations

Since dew condensation may occur by the differences in temperature when the products are taken out of storage, it is important to maintain a temperature controlled environment.

2.Design of Solder Land Pattern

When designing printed circuit boards, the shape and size of the solder lands must allow for the proper amount of solder on the capacitor. The amount of solder at the end terminations has a direct effect on the probability that the chip will crack. The greater amount of solder, the larger amount of stress on the chip, and the more likely that it will break. Use the following illustrations as guidelines for proper Solder land design.

Recommendation of solder Land Shape and Size

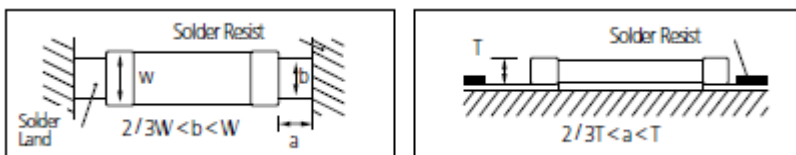

3.Adhesives

MLCCs generally require the use of an adhesive to position the chips to the circuit board prior to soldering.

3 1. Requirements for Adhesives

- They must have enough adhesion so that the chips will not fall off or move during the handling of the circuit board.
- They must maintain their adhesive strength when exposed to soldering temperatures.
- They should not spread or run when applied to the circuit board.
- They should have a long pot life.
- They should harden quickly.
- They should not corrode the circuit board or chip material.
- They should be a good insulator.

They should be nontoxic, and not produce harmful gases, nor be harmful when touched.

3.2. Application Method

It is important to use the proper amount of adhesive. Too little will cause poor adhesion to the circuit board, and too much may strain the conductor pattern, thereby causing defective soldering. The following illustrations show the proper quantity of adhesive.

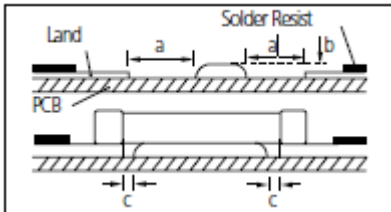

Unit: mm

Type	0805	1206
a	0.2min	0.2min
b	70~100um	70~100m
c	>0	>0

3.3. Adhesive hardening Characteristics

To prevent oxidation of the terminations, the adhesive must harden at 160°C or less, within 2 minutes or less.

4. Mounting

4.1. Mounting Head Pressure

Excessive pressure will cause chip capacitors to crack. The pressure between nozzle and chip capacitor will be 300g maximum during mounting.

4.2. Bending Stress

Bending of printed circuit board by mounting head when double sided circuit boards are used, chip capacitors first are mounted and soldered onto one side of the board. When the capacitors are mounted onto the other side, it is important to support the board as shown in the illustration. If the circuit board is not supported, it may bend, causing the already installed capacitors to crack.

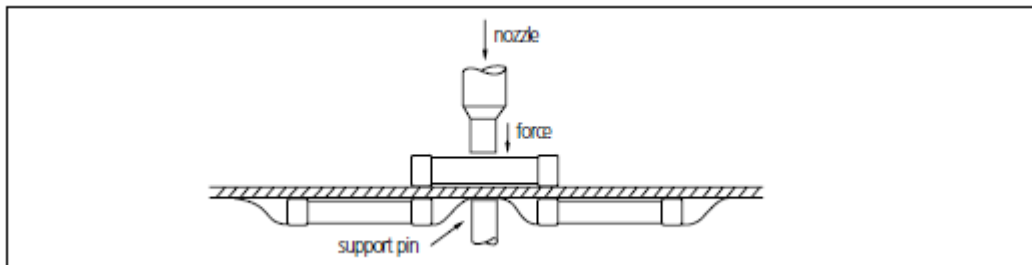

5. Flux

Although highly activated flux gives better solderability, substances which increase activity may also degrade the insulation of the chip capacitors, To avoid such degradation, it is recommended that a mildly activated rosin flux (less than 0.2% chlorine) be used.

6. Soldering

Since a multilayer ceramic chip capacitor comes into direct contact with melted solder during soldering, it is exposed to potentially mechanical stress caused by the sudden temperature change. The capacitor may also be subject to silver migration, and to contamination by the flux. Because of these factors, soldering technique is critical.

6.1. Soldering Methods

Method	Classification	
Reflow soldering	<ul style="list-style-type: none"> Overall heating 	<ul style="list-style-type: none"> Infrared rays Hot plate VPS (Vapor phase)
	<ul style="list-style-type: none"> Local heating 	<ul style="list-style-type: none"> Air heater Laser Light beam
Flow Soldering	<ul style="list-style-type: none"> Single wave Double wave 	

6.2. Soldering Profile

To avoid the crack problem by sudden temperature change, follow the temperature profile in the adjacent graph.

6.2.1 Pb Free (Sn 100%) Plating

➤ REFLOW SOLDERING

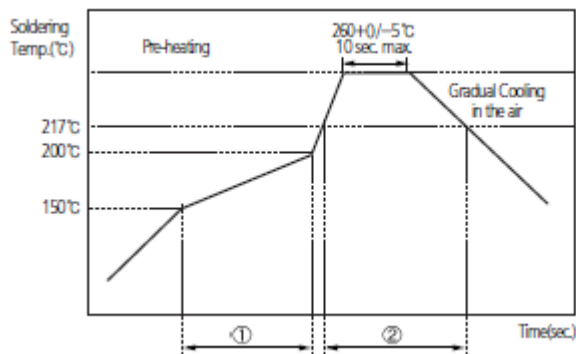

Soldering Temp. (°C)	Pre heating Time ((1), sec.)	Soldering Time ((2), sec.)
-------------------------	----------------------------------	--------------------------------

260+0/-5°C	60~120	60~150
------------	--------	--------

➤ **FLOW SOLDERING**

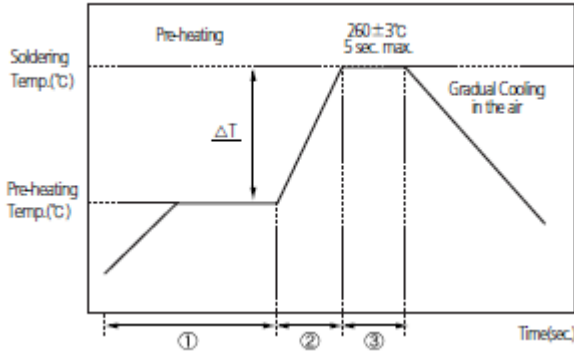

$\Delta T(^{\circ}C)$	Soldering Temp. ($^{\circ}C$)	Pre heating Time ((1)+(2), sec.)	Soldering Time ((3), sec.)
≤ 150 (1206 and below size)	260 \pm 3	≥ 120	≤ 5

➤ **SOLDER IRON (Hand Soldering)**

Variation of Temp.($^{\circ}C$)	Soldering Temp($^{\circ}C$)	Pre heating Time(sec.)	Soldering Time(sec.)	Cooling Time(sec.)	Condition of Iron Facilities		
					Wattage	Tip Diameter	Soldering Time
$\Delta T \leq 130$	300 \pm 10 $^{\circ}C$ max.	≥ 60 sec.	≤ 4 sec.		20W max.	3mm max.	4 sec max.

❖ **Caution** Iron tip should not contact with ceramic body directly

6 3. Manual Soldering

Manual soldering can pose a great risk of creating thermal cracks in chip capacitors. The hot soldering iron tip comes into direct contact with the end terminations, and operator’s carelessness may cause the tip of the soldering iron to come into direct contact with the ceramic body of the capacitor. Therefore the soldering iron must be handled carefully, and close attention must be paid to the selection of the soldering iron tip and to temperature control of the tip.

6 4. Amount of Solder

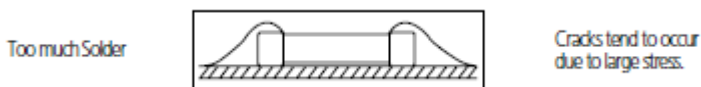

Not enough solder

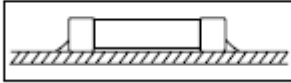

Weak holding force may cause bad connections or detaching of the capacitor

6 5. Cooling

Natural cooling using air is recommended. If the chips are dipped into solvent for cleaning, the temperature difference (ΔT) must be less than 100°C

6 6. Cleaning

If rosin flux is used, cleaning usually is unnecessary. When strongly activated flux is used, chlorine in the flux may dissolve into some types of cleaning fluids, thereby affecting the chip capacitors. This means that the cleaning fluid must be carefully selected, and should always be new.

7. Notes for Separating Multiple, Shared PC Boards

A multi PC board is separated into many individual circuit boards after soldering has been completed. If the board is bent or distorted at the time of separation, cracks may occur in the chip capacitors. Carefully choose a separation method that minimizes the bending of the circuit board.

Sales and Support

InfineX Headquarters
12501B Research Blvd.
Austin, TX USA 78759

Sales@InfineX.com
Engineering@InfineX.com

Flex (including its affiliates, employees, agents and other persons acting on Flex's behalf), reserve the right to make modifications, improvements, corrections or other changes without further notice to any product herein. The product information is provided only for reference purposes and Flex does not assume any liability arising out of an application or use of any product described herein and disclaims any warranties expressed or implied; neither does it convey any license under its patent rights, nor the right of others. The user of products in such applications shall assume all risks of such use and will agree to hold Flex, and all the companies whose products are represented on our website, harmless against all damages.

Copyright © 2016, Flex Ltd. All rights reserved. No part of this document may be reproduced in any form without the prior written permission of Flex.

Document Revision Number: 1.0, 06/15/2015

Flex Ltd., formerly Flextronics International Ltd., is a leading Sketch-to-Scale™ solutions provider that designs and builds intelligent products for a connected world. With approximately 200,000 professionals across 30 countries, Flex provides innovative design, engineering, manufacturing, real-time supply chain insight and logistics services to companies of all sizes in various industries and end-markets.

For more information, visit
flextronics.com

Follow us on Twitter @Flextronics